

# UG10ACT THRU UG10DCT

## ULTRAFAST SOFT RECOVERY RECTIFIER

Reverse Voltage - 200 Volts

Forward Current - 10.0 Amperes

### TO-220AB

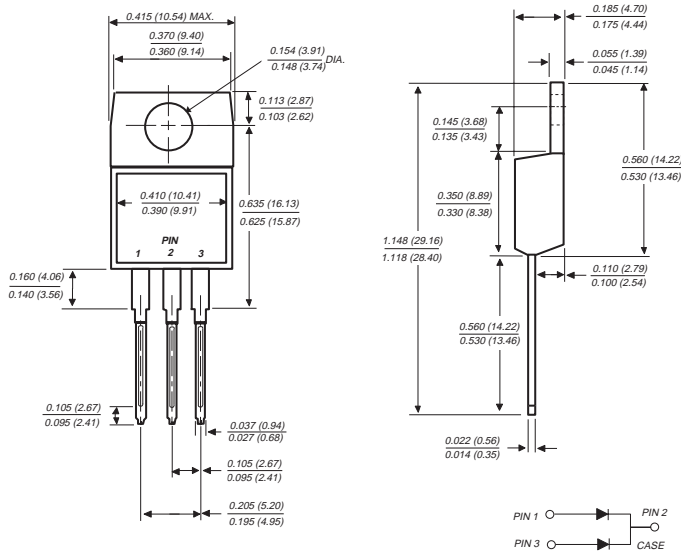

Dimensions in inches and (millimeters)

### FEATURES

- ◆ Plastic package has Underwriters Laboratories Flammability Classification 94V-0
- ◆ Ideally suited for free wheeling diode power factor correction applications
- ◆ Soft recovery characteristics
- ◆ Excellent high temperature switching
- ◆ Optimized to reduce switching losses
- ◆ High temperature soldering guaranteed: 250°C/10 seconds at terminals
- ◆ Glass passivated chip junction

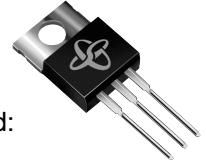

### MECHANICAL DATA

**Case:** JEDEC TO-220AB molded plastic body

**Terminals:** Plated leads, solderable per MIL-STD-750, Method 2026

**Polarity:** As marked

**Mounting Position:** Any

**Mounting Torque:** 5 in. - lbs. max.

**Weight:** 0.08 ounce, 2.24 grams

### MAXIMUM RATINGS AND ELECTRICAL CHARACTERISTICS

Ratings at 25°C ambient temperature unless otherwise specified.

	SYMBOLS	UG10ACT	UG10BCT	UG10CCT	UG10DCT	UNITS
Maximum repetitive peak reverse voltage	V <sub>RRM</sub>	50	100	150	200	Volts
Working peak reverse voltage	V <sub>RWM</sub>	50	100	150	200	Volts
Maximum RMS voltage	V <sub>RMS</sub>	35	70	105	140	Volts
Maximum DC blocking voltage	V <sub>DC</sub>	50	100	150	200	Volts
Maximum average forward rectified current at T <sub>C</sub> =100°C	I <sub>(AV)</sub>	10				Amps
Peak forward surge current 8.3ms single half sine-wave superimposed on rated load (JEDEC Method) per leg	I <sub>FSM</sub>	60				Amps
Maximum instantaneous forward voltage per leg at I <sub>F</sub> =10A, T <sub>J</sub> =25°C I <sub>F</sub> =5A, T <sub>J</sub> =25°C I <sub>F</sub> =5A, T <sub>J</sub> =150°C	V <sub>F</sub>	1.25 1.10 0.895				Volts
Maximum reverse leakage current per leg at working peak reverse voltage	I <sub>R</sub>	10 200				μA
Maximum reverse recovery time per leg at I <sub>F</sub> =1.0A, di/dt=100A/μs, V <sub>R</sub> =30V, I <sub>rr</sub> =0.1 I <sub>RM</sub>	t <sub>rr</sub>	25				ns
Maximum reverse recovery time per leg at I <sub>F</sub> =0.5A, I <sub>R</sub> =1.0A, I <sub>rr</sub> =0.25A	t <sub>rr</sub>	25 15				ns
Maximum reverse recovery current per leg at I <sub>F</sub> =5A, di/dt=50A/μs, V <sub>R</sub> =30V	I <sub>RM</sub>	0.7				Amps
Maximum stored charge per leg I <sub>F</sub> =2A, di/dt=20A/μs, V <sub>R</sub> =30V I <sub>rr</sub> =0.1 I <sub>RM</sub>	Q <sub>rr</sub>	5.5 4.5				nC
Typical thermal resistance from junction to case per leg	R <sub>θJC</sub>	4.5				°C/W
Operating junction and storage temperature range	T <sub>J</sub> , T <sub>STG</sub>	-40 to +150				°C

**NOTICE:** Advanced product information is subject to change without notice

# RATINGS AND CHARACTERISTIC CURVES UG10ACT THRU UG10DCT

FIG. 1 - FORWARD CURRENT DERATING CURVE

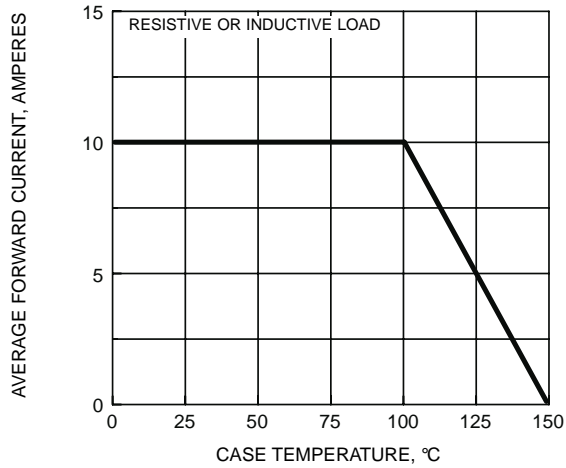

FIG. 2 - MAXIMUM NON-REPETITIVE PEAK FORWARD SURGE CURRENT PER LEG

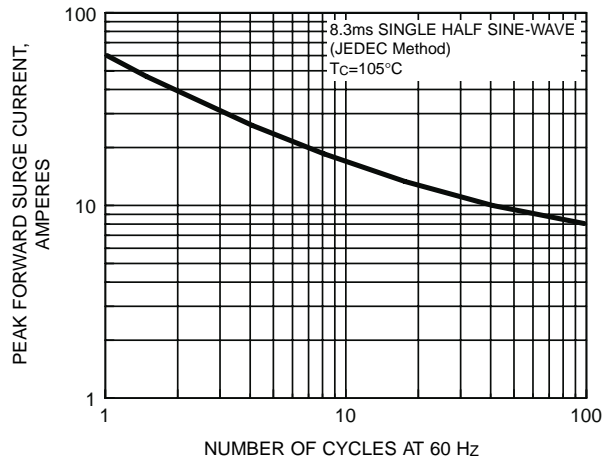

FIG. 3 - TYPICAL INSTANTANEOUS FORWARD CHARACTERISTICS PER LEG

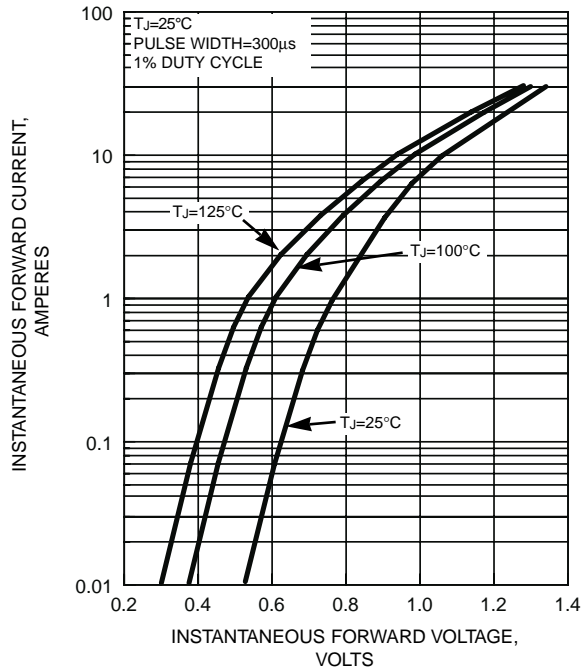

FIG. 4 - TYPICAL REVERSE CHARACTERISTICS PER LEG

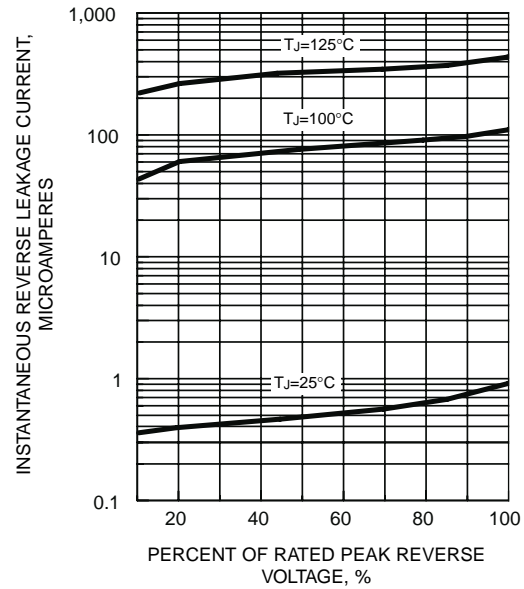

FIG. 5 - REVERSE SWITCHING CHARACTERISTICS PER LEG

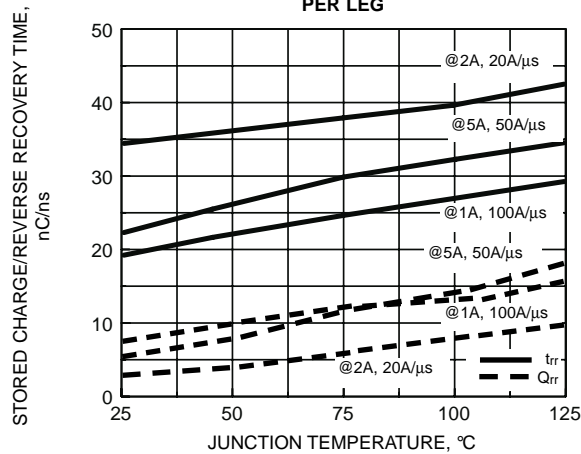

FIG. 6 - TYPICAL JUNCTION CAPACITANCE PER LEG

