

Dual PNP Digital Transistors

HBA143ES6R

Features

- Built-in bias resistors enable the configuration of an inverter circuit without connecting external input resistors (see equivalent circuit).
- The bias resistors consist of thin-film resistors with complete isolation to allow positive biasing of the input. They also have the advantage of almost completely eliminating parasitic effects.
- Only the on/off conditions need to be set for operation, making device design easy.
- Two DTA143E chips in a SOT-363 package.
- Mounting by SOT-323 automatic mounting machines is possible.
- Mounting cost and area can be cut in half.
- Transistor elements are independent, eliminating interference
- Complements the HBC143ES6R

Equivalent Circuit

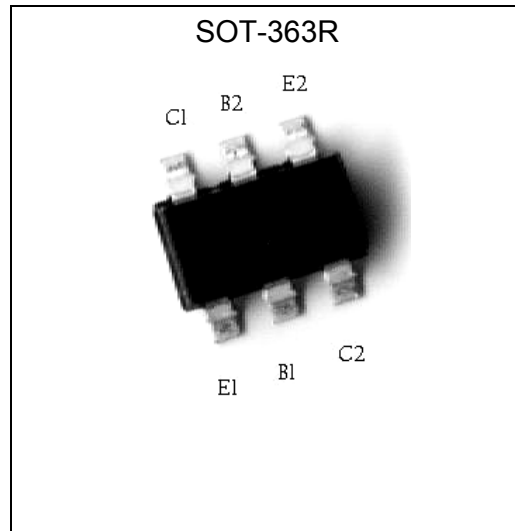
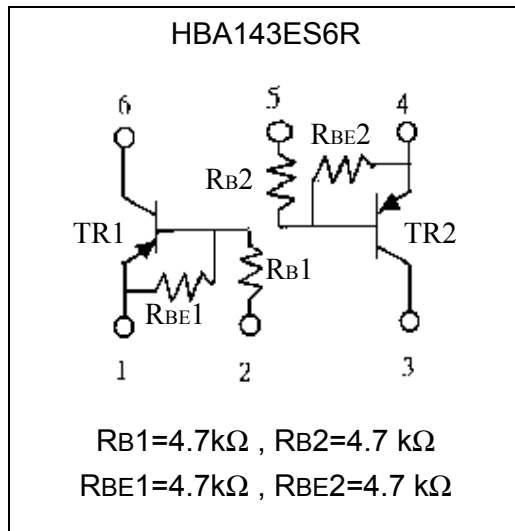

**Absolute Maximum Ratings** (Each Transistor, Ta=25°C)

Parameter	Symbol	Limits	Unit
Supply Voltage	V _{CC}	-50	V
Input Voltage	V _{IN}	-30~+10	V
Output Current	I _O	-100	mA
	I _{O(max.)}	-100	mA
Power Dissipation	P _d	200 (Note)	mW
Junction Temperature	T _j	150	°C
Storage Temperature	T _{stg}	-55~+150	°C

Note : 150mW per element must not be exceeded.

Characteristics (Each Transistor, Ta=25°C)

Parameter	Symbol	Min.	Typ.	Max.	Unit	Test Conditions
Input Voltage	V _{I(off)}	-	-	-0.5	V	V _{CC} =-5V, I _O =-100μA
	V _{I(on)}	-3	-	-	V	V _O =-0.3V, I _O =-20mA
Output Voltage	V _{O(on)}	-	-	-0.3	V	I _O /I _I =-10mA/-0.5mA
Input Current	I _I	-	-	-1.8	mA	V _I =-5V
Output Current	I _{O(off)}	-	-	-0.5	μA	V _{CC} =-50V, V _I =0V
DC Current Gain	G _I	20	-	-	-	V _O =-5V, I _O =-10mA
Input Resistance	R ₁	3.29	4.7	6.11	kΩ	-
Resistance Ratio	R ₂ /R ₁	0.8	1	1.2	-	-
Transition Frequency	f _T	-	250	-	MHz	V _{CE} =-10V, I _C =-5mA, f=100MHz *

* Transition frequency of the device



Characteristic Curves

Current Gain vs Output Current

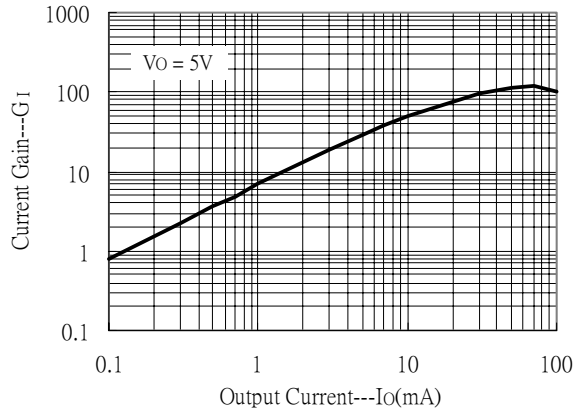

Output Voltage vs Output Current

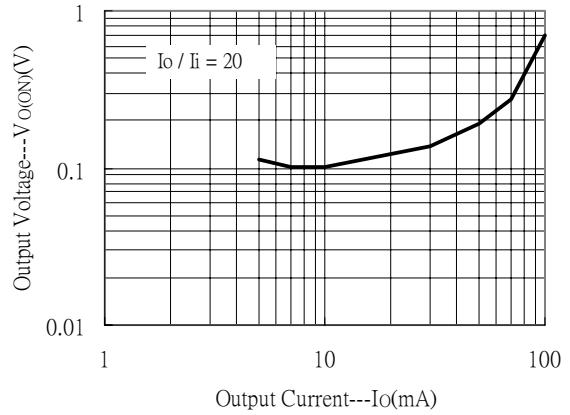

Input Voltage vs Output Current(ON characteristics)

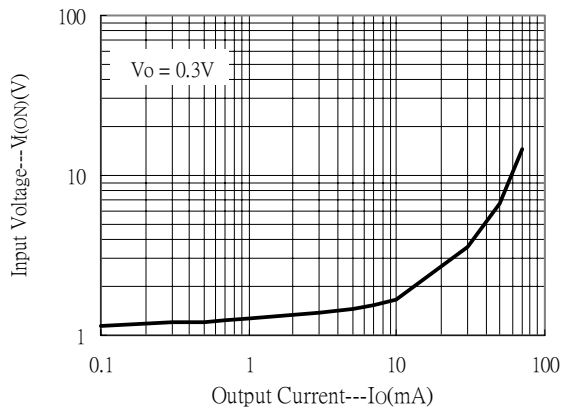

Output Current vs Input Voltage(OFF characteristics)

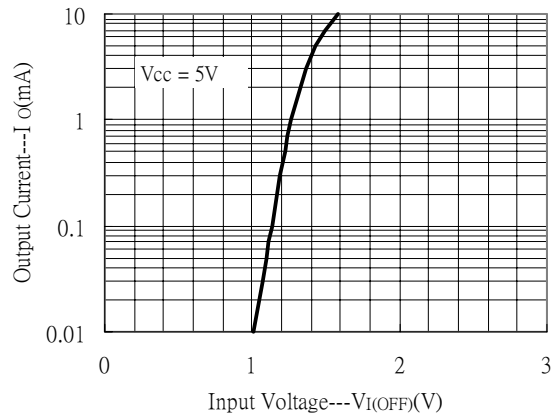

Power Derating Curves

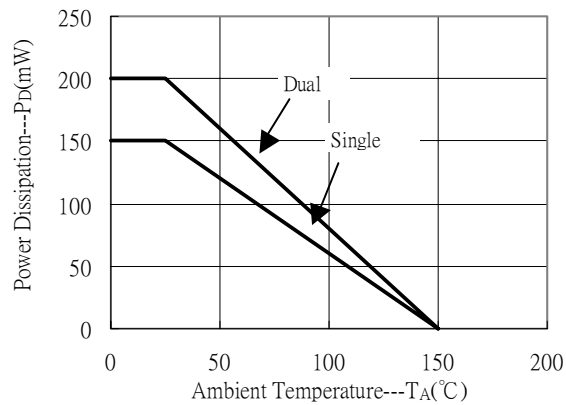

SOT-363R Dimension

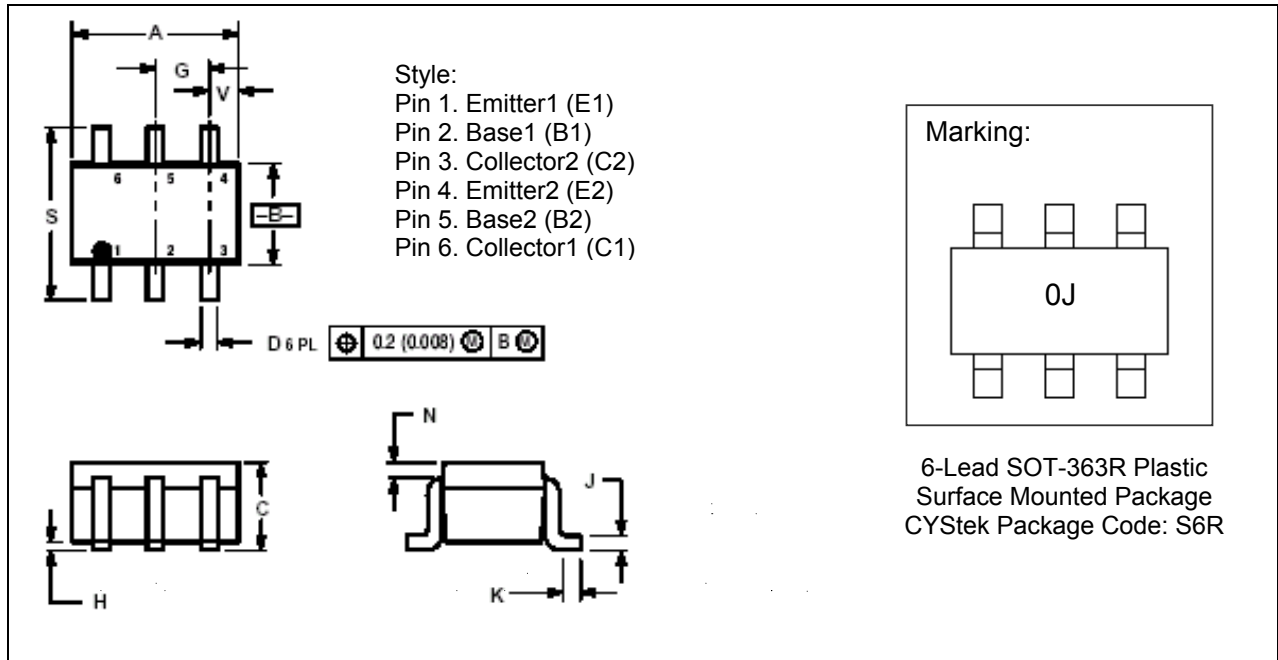

*:Typical

DIM	Inches		Millimeters		DIM	Inches		Millimeters	
	Min.	Max.	Min.	Max.		Min.	Max.	Min.	Max.
A	0.071	0.087	1.8	2.2	J	0.004	0.010	0.1	0.25
B	0.045	0.053	1.15	1.35	K	0.004	0.012	0.1	0.30
C	0.031	0.043	0.8	1.1	N	0.008 REF		0.20 REF	
D	0.004	0.012	0.1	0.3	S	0.079	0.087	2.00	2.20
G	0.026BSC		0.65BSC		Y	0.012	0.016	0.30	0.40
H	-	0.004	-	0.1					

- Notes : 1. Controlling dimension : millimeters.
 2. Maximum lead thickness includes lead finish thickness, and minimum lead thickness is the minimum thickness of base material.
 3. If there is any question with packing specification or packing method, please contact your local CYStek sales office.

Material :

- Lead : 42 Alloy ; solder plating
- Mold Compound : Epoxy resin family, flammability solid burning class:UL94V-0

Important Notice:

- All rights are reserved. Reproduction in whole or in part is prohibited without the prior written approval of CYStek.
- CYStek reserves the right to make changes to its products without notice.
- CYStek **semiconductor products are not warranted to be suitable for use in Life-Support Applications, or systems.**
- CYStek assumes no liability for any consequence of customer product design, infringement of patents, or application assistance.