

Surface Mount Zener Diodes



CZRT5221-G thru CZRT5259-G

Voltage: 2.4 ~ 29 Volts

Power: 500 mW

Features:

- Planar Die Constructions
- 500mW Power Dissipation
- Zener Voltages from 2.4V ~ 39V
- Ideally Suited for Automated Assembly Processes

Mechanical Data:

- Case: SOD-23, Plastic
- Terminals: Solderable per MIL-STD-202, Method 208
- Approx. Weight: 0.008 gram

Circuit Schematic:

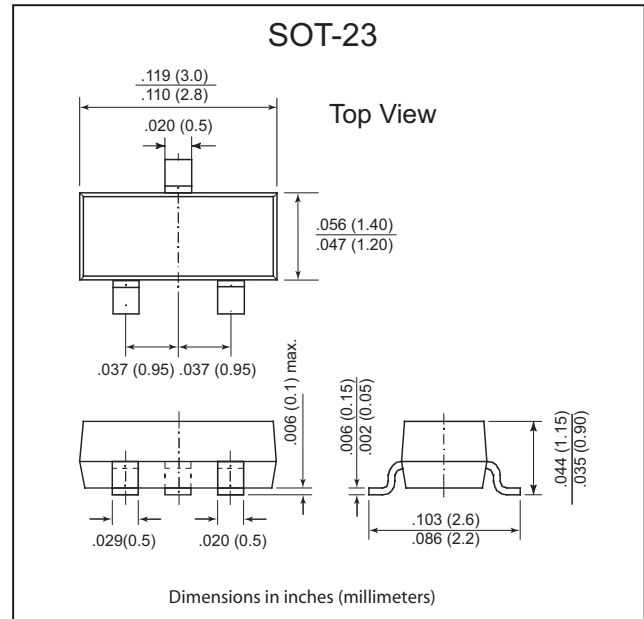
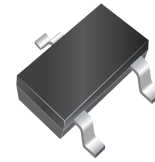
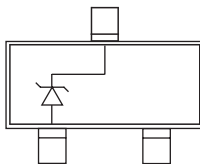

Maximum Ratings and Thermal Characteristics

Parameter	Symbols	Value	Units
Power Dissipation (Note A) at 75°C	P_D	500	mW
Peak Forward Surge Current Surge, 8.3ms Single Half Sine-Wave Superimposed on Rated Load (JEDEC Method) (Note B)	I_{FSM}	4	Amps
Operating Junction and Storage Temperature Range	T_J	-55 to +150	°C

Notes:

A. Mounted on 5.0mm²(.013mm thick) land areas.

B. Measured on 8.3ms, single half sine-wave or equivalent square wave, duty cycle = 4 pulses per minute maximum.

Surface Mount Zener Diodes



CZRT5221-G thru CZRT5259-G

Electrical Characteristics (T_A = 25°C unless otherwise noted) V_F=1.2V max, I_F=100mA for all types.)

Part Number	Max. Zener Impedance			Max. Zener Impedance				Max Reverse Leakage Current		Typical Temp. Coefficient	Max. Zener current
	V _Z @ I _{ZT}			Z _{ZT} @ I _{ZT}		Z _{ZK} @ I _{ZK}		I _R @ V _R		T _C	I _{ZM} @ T _a
	Nom.V	Min.V	Max.V	Ohm	mA	Ohm	mA	nA	V		mA
500 mWatts Zener Diodes											
CZRT5221-G	2.4	2.28	2.52	30	20	1200	0.25	100	1	-0.070	188
CZRT5222-G	2.5	2.38	2.63	30	20	1250	0.25	100	1	-0.065	180
CZRT5223-G	2.7	2.57	2.84	30	20	1300	0.25	75	1	-0.060	167
CZRT5225-G	3	2.85	3.15	30	20	1600	0.25	50	1	-0.055	150
CZRT5226-G	3.3	3.14	3.47	28	20	1600	0.25	25	1	0.030	138
CZRT5227-G	3.6	3.42	3.78	25	20	1700	0.25	15	1	0.030	126
CZRT5228-G	3.9	3.71	4.10	23	20	1900	0.25	10	1	+0.038	115
CZRT5229-G	4.3	4.09	4.52	22	20	2000	0.25	5	1	+0.038	106
CZRT5230-G	4.7	4.47	4.94	19	20	1900	0.25	5	2	+0.045	97
CZRT5231-G	5.1	4.85	5.36	17	20	1600	0.25	5	2	+0.050	89
CZRT5232-G	5.6	5.32	5.88	11	20	1600	0.25	5	3	+0.058	81
CZRT5233-G	6.0	5.70	6.30	11	20	1600	0.25	5	3.5	+0.060	77
CZRT5234-G	6.2	5.89	6.51	7	20	1000	0.25	5	4	+0.062	73
CZRT5235-G	6.8	6.46	7.14	5	20	750	0.25	3	5	+0.065	67
CZRT5236-G	7.5	7.13	7.88	6	20	500	0.25	3	6	+0.068	61
CZRT5237-G	8.2	7.79	8.61	8	20	500	0.25	3	6	+0.075	55
CZRT5239-G	9.1	8.65	9.56	10	20	600	0.25	3	6.5	+0.076	50
CZRT5240-G	10	9.50	10.50	17	20	600	0.25	3	8	+0.077	45
CZRT5241-G	11	10.45	11.55	22	20	600	0.25	3	8.4	+0.079	41
CZRT5242-G	12	11.40	12.60	30	20	600	0.25	2	9.1	+0.082	38
CZRT5243-G	13	12.35	13.65	13	9.5	600	0.25	1	9.9	+0.082	35
CZRT5245-G	15	14.25	15.75	16	8.5	600	0.25	0.5	11	+0.083	30
CZRT5246-G	16	15.20	16.80	17	7.8	600	0.25	0.1	12	+0.084	28
CZRT5248-G	18	17.10	18.90	21	7	600	0.25	0.1	14	+0.085	25
CZRT5250-G	20	19.00	21.00	25	6.2	600	0.25	0.1	15	+0.086	23
CZRT5251-G	22	20.90	23.10	29	5.6	600	0.25	0.1	17	+0.086	21
CZRT5252-G	24	22.80	25.20	33	5.2	600	0.25	0.1	18	+0.087	19.1
CZRT5254-G	27	25.65	28.35	41	5	600	0.25	0.1	21	+0.087	16.8
CZRT5255-G	28	26.60	29.40	44	4.5	600	0.25	0.1	21	+0.089	16.2
CZRT5256-G	30	28.50	31.50	49	4.2	600	0.25	0.1	23	+0.090	15.1
CZRT5257-G	33	31.35	34.65	58	3.8	700	0.25	0.1	25	+0.091	13.8
CZRT5258-G	36	34.20	37.80	70	3.4	700	0.25	0.1	27	+0.091	12.6
CZRT5259-G	39	37.05	40.95	80	3.2	800	0.25	0.1	30	+0.092	11.6

NOTE:

1. Tolerance and Type Number Designation. The type numbers listed have a standard tolerance on the nominal zener voltage of ±5% for 'B' and ±10% for 'A'
2. Specials Available Include:
 - A. Nominal zener voltages between the voltages shown and tighter voltage tolerances.
 - B. Matched sets.
3. Zener Voltage (V_Z) Measurement. Guarantees the zener voltage when measured at 90 seconds while maintaining the lead temperature (T_L) at 30°C from the diode body.
4. Zener Impedance (Z_Z) Derivation. The zener impedance is derived from the 60 cycle ac voltage, which results when an AC current having an rms value equal to 10% of the dc zener current (I_{ZT} or I_{ZK}) is superimposed on I_{ZT} or I_{ZK}
5. Surge Current (I_R) Non-Repetitive. The rating listed in the electrical characteristics table is maximum peak, non-repetitive, reverse surge current of 1/2 square wave or equivalent sine wave pulse of 1/120 second duration superimposed on the test current, I_{ZT}, per JEDEC registration; however, actual device capability is as described in Figure 5.

"-G" suffix designated RoHS compliant version

Surface Mount Zener Diodes



CZRT5221-G thru CZRT5259-G

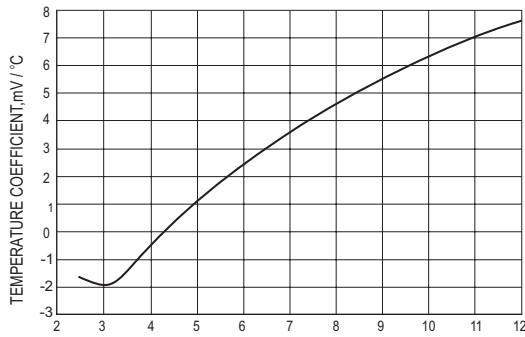

NOMINAL ZENER VOLTAGE, Volts

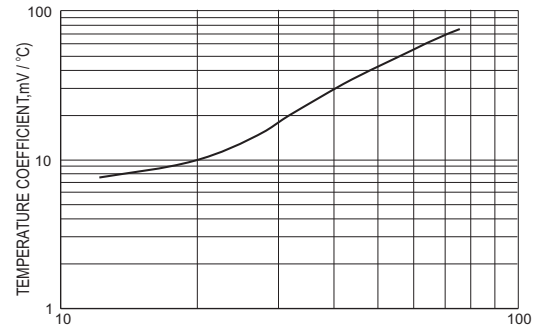

NOMINAL ZENER VOLTAGE, Volts

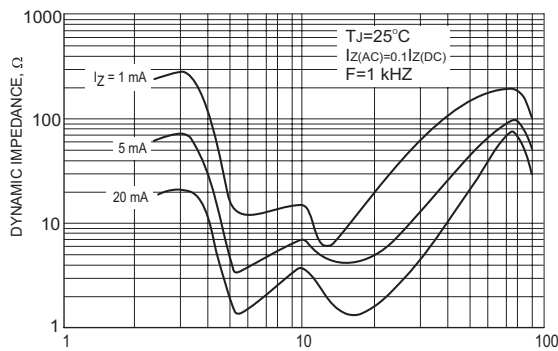

NORMAL ZENER VOLTAGE, Volts

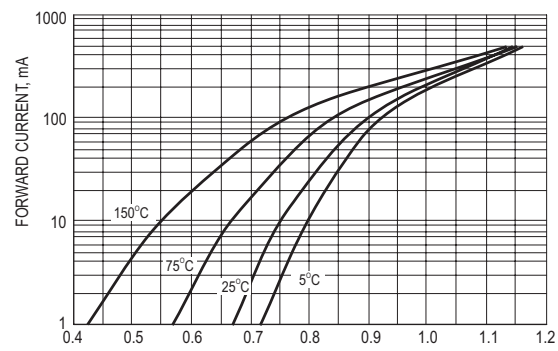

FORWARD VOLTAGE, Volts

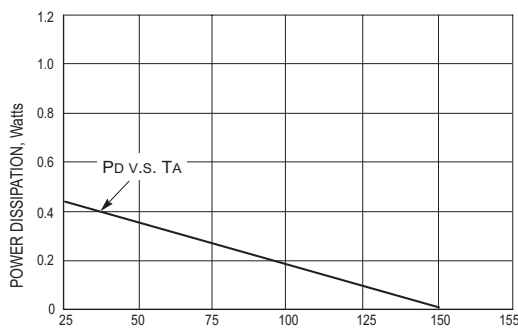

TEMPERATURE (°C)

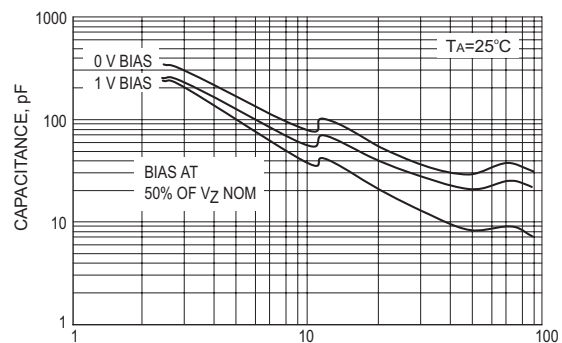

NOMINAL ZENER VOLTAGE, Volts

"-G" suffix designated RoHS compliant version



CZRT5221-G thru CZRT5259-G

