

Surface Mount Zener Diode

CZRB3011 Thru CZRB3100

Voltage: 11 - 100 Volts

Power: 3.0 Watt

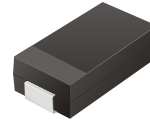

Features

- For surface mounted applications in order to optimize board space
- Low profile package
- Built-in strain relief
- Glass passivated junction
- Low inductance
- Excellent clamping capability
- Typical I_b less than 1uA above 11V
- High temperature soldering 260°C /10 seconds at terminals
- Plastic package has underwriters laboratory flammability classification 94V-O

Mechanical data

- Case: JEDEC DO-214AA, Molded plastic over passivated junction
- Terminals: Solder plated, solderable per MIL-STD-750, method 2026
- Polarity: Color band denotes positive end (cathode) except Bidirectional
- Standard Packaging: 12mm tape (EIA-481)
- Weight: 0.002 ounce, 0.064 gram

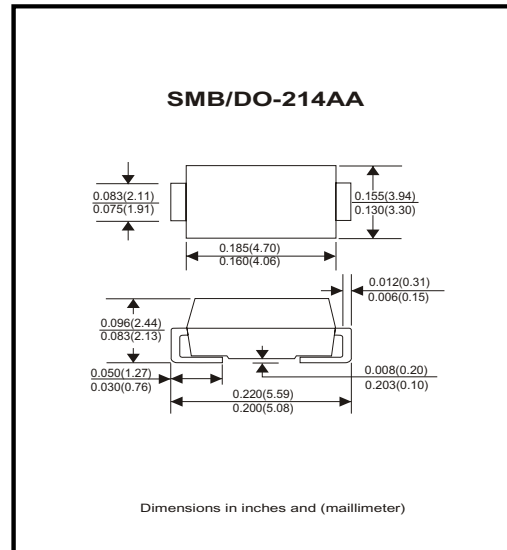

Maximum Ratings and Electrical Characteristics

Ratings at 25°C ambient temperature unless otherwise specified.

Rating	Symbol	Value	Units
Peak Pulse Power Dissipation (Note A) Derate above 75	P_D	3 24	Watts mW/°C
Peak forward Surge Current 8.3ms single half sine-wave superimposed on rated load (JEDEC Method) (Note B)	I_{FSM}	15	Amps
Operating Junction and Storage Temperature Range	T_J, T_{STG}	-55 to +150	°C

ELECTRICAL CHARACTERISTICS

($T_A=25^{\circ}\text{C}$ unless otherwise noted) ($V_F=1.2\text{Volts Max}$, $I_F=500\text{mA}$ for all types.)

Device (Note 1.)	Nominal Zener Voltage V_Z @ I_{ZT} (Note 2.) (Volts)	Test current I_{ZT} (mA)	Maximum Zener Impedance (Note 3.)			Leakage Current		Maximum Zener Current I_{ZM} I_{ZM} Madc	Surge Current @ $T_A=25^{\circ}\text{C}$ (Note 4.) I_r - mA
			Z_{ZT} @ I_{ZT} (Ohms)	Z_{ZK} @ I_{ZK} (Ohms)	I_{ZK} (mA)	I_R (uA)	V_R (Volts)		
CZRB3011	11	68	4	700	0.25	1	8.4	225	1.82
CZRB3012	12	63	4.5	700	0.25	1	9.1	246	1.66
CZRB3013	13	58	4.5	700	0.25	0.5	9.9	208	1.54
CZRB3014	14	53	5	700	0.25	0.5	10.6	193	1.43
CZRB3015	15	50	5.5	700	0.25	0.5	11.4	180	1.33
CZRB3016	16	47	5.5	700	0.25	0.5	12.2	169	1.25
CZRB3017	17	44	6	750	0.25	0.5	13	150	1.18
CZRB3018	18	42	6	750	0.25	0.5	13.7	159	1.11
CZRB3019	19	40	7	750	0.25	0.5	14.4	142	1.05
CZRB3020	20	37	7	750	0.25	0.5	15.2	135	1.00
CZRB3022	22	34	8	750	0.25	0.5	16.7	123	0.91
CZRB3024	24	31	9	750	0.25	0.5	18.2	112	0.83
CZRB3027	27	28	10	750	0.25	0.5	20.6	100	0.74
CZRB3028	28	27	12	750	0.25	0.5	21	96	0.71
CZRB3030	30	25	16	1000	0.25	0.5	22.5	90	0.67
CZRB3033	33	23	20	1000	0.25	0.5	25.1	82	0.61
CZRB3036	36	21	22	1000	0.25	0.5	27.4	75	0.56
CZRB3039	39	19	28	1000	0.25	0.5	29.7	69	0.51
CZRB3043	43	17	33	1500	0.25	0.5	32.7	63	0.45
CZRB3047	47	16	38	1500	0.25	0.5	35.6	57	0.42
CZRB3051	51	15	45	1500	0.25	0.5	38.8	53	0.39
CZRB3056	56	13	50	2000	0.25	0.5	42.6	48	0.36
CZRB3062	62	12	55	2000	0.25	0.5	47.1	44	0.32
CZRB3068	68	11	70	2000	0.25	0.5	51.7	40	0.29
CZRB3075	75	10	85	2000	0.25	0.5	56	36	0.27
CZRB3082	82	9.1	95	3000	0.25	0.5	62.2	33	0.24
CZRB3091	91	8.2	115	3000	0.25	0.5	69.2	30	0.22
CZRB3100	100	7.5	160	3000	0.25	0.5	76	27	0.20

NOTE:

1. Tolerance and Type Number Designation. The type numbers listed have a standard tolerance on the nominal zener voltage of $\pm 5\%$.
2. ZENER VOLTAGE (V_Z) MEASUREMENT - guarantees the zener voltage when measured at 40 ms +/- 10ms from the diode body, and an ambient temperature of 25°C ($+8^{\circ}\text{C}$, -2°C).
3. ZENER IMPEDANCE (Z_Z) DERIVATION - The zener impedance is derived from the 60 cycle ac voltage, which results when an ac current having an rms value equal to 10% of the dc zener current (I_{ZT} or I_{ZK}) is superimposed on I_{ZT} or I_{ZK} .
4. SURGE CURRENT (I_r) NON-REPETITIVE - The rating listed in the electrical characteristics table is maximum peak, non-repetitive, reverse surge current of 1/2 square wave or equivalent sine wave pulse of 1/120 second duration superimposed on the test current, I_{ZT} , per JEDEC standards, however, actual device capability is as described in Figure 3.

Rating and Characteristic Curves (CZRB3011 Thru CZRB3100)

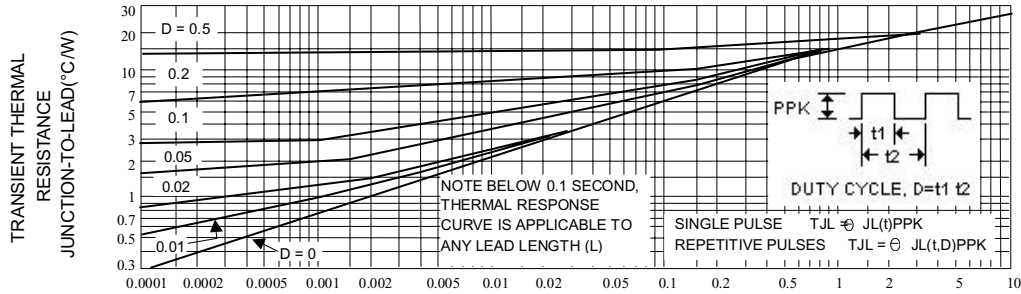

Fig. 2-TYPICAL THERMAL RESPONSE L,

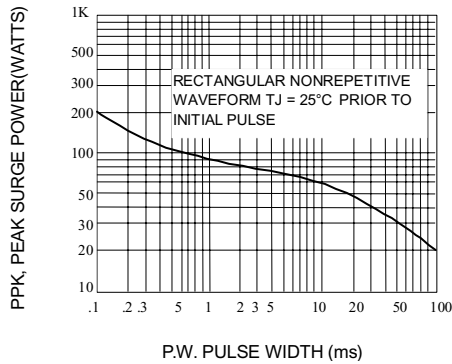

Fig. 3-MAXIMUM SURGE POWER

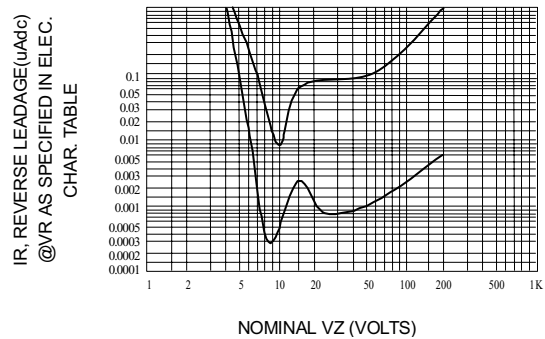

Fig. 4-TYPICAL REVERSE LEAKAGE

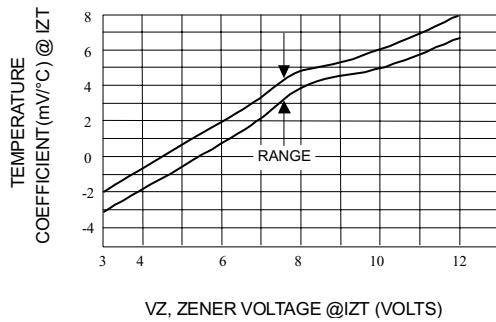

Fig. 5 - UNITS TO 12 VOLTS

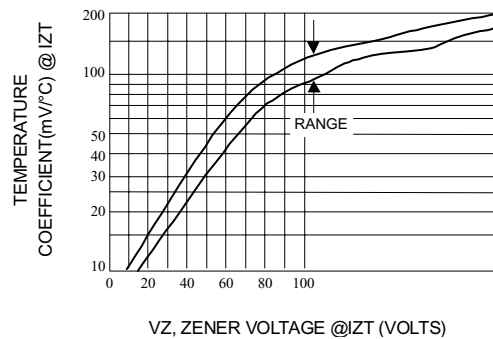
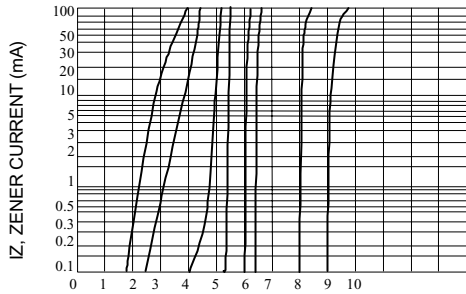
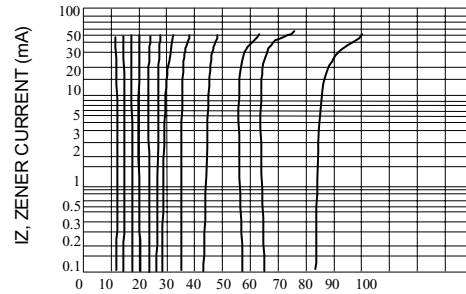

Fig. 6 - UNITS 10 TO 100 VOLTS

Rating and Characteristic Curves (CZRB3011 Thru CZRB3100)



V_Z , ZENER VOLTAGE (VOLTS)



V_Z , ZENER VOLTAGE (VOLTS)

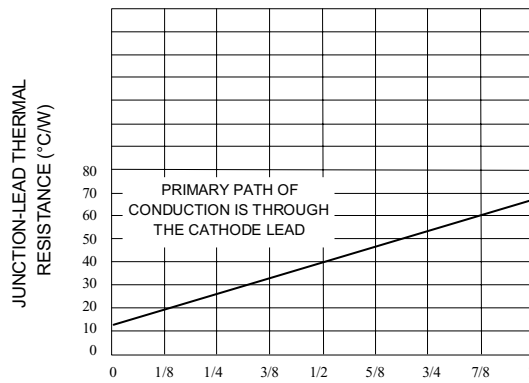

L , LEAD LENGTH TO HEAT SINK (INCH)

TYPICAL THERMAL RESISTANCE

APPLICATION NOTE:

Since the actual voltage available from a given zener diode is temperature dependent, it is necessary to determine junction temperature under any set of operating conditions in order to calculate its value. The following procedure is recommended:

Lead Temperature, T_L , should be determined from:

$$T_L = \theta_{LA} P_D + T_A$$

θ_{LA} is the lead-to-ambient thermal resistance ($^{\circ}\text{C}/\text{W}$) and P_D is the power dissipation. The value for θ_{LA} will vary and depends on the device mounting method. θ_{LA} is generally 30–40 $^{\circ}\text{C}/\text{W}$ for the various chips and tie points in common use and for printed circuit board wiring.

The temperature of the lead can also be measured using a thermocouple placed on the lead as close as possible to the tie point. The thermal mass connected to the tie point is normally large enough so that it will not significantly respond to heat surges generated in the diode as a result of pulsed operation once steady-state conditions are achieved. Using the measured value of T_L , the junction temperature may be determined by:

$$T_J = T_L + \Delta T_{JL}$$

ΔT_{JL} is the increase in junction temperature above the lead temperature and may be found from Figure 2 for a train of power pulses or from Figure 10 for dc power.

$$\Delta T_{JL} = \theta_{LA} P_D$$

For worst-case design, using expected limits of I_z , limits of P_D and the extremes of T_J (ΔT_{JL}) may be estimated.

Changes in voltage, V_z , can then be found from:

$$\Delta V = \theta_{VZ} \Delta T_J$$

θ_{VZ} , the zener voltage temperature coefficient, is found from Figures 5 and 6.

Under high power-pulse operation, the zener voltage will vary with time and may also be affected significantly by the zener resistance. For best regulation, keep current excursions as low as possible.

Data of Figure 2 should not be used to compute surge capability. Surge limitations are given in Figure 3. They are lower than would be expected by considering only junction temperature, as current crowding effects cause temperatures to be extremely high in small spots resulting in device degradation should the limits of Figure 3 be exceeded.