

SMD Zener Diode



SMD Diodes Specialist

CZRA5920B-G Thru CZRA5956B-G

Voltage: 6.2 to 200 Volts

Power: 1.5 Watts

RoHS Device

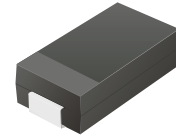

Features

- Glass passivated chip.
- Low leakage.
- Built-in strain relief.
- Low inductance.
- High peak reverse power dissipa.
- Lead(Pb)-free component.
- For use in stabilizing and clipping circuits with high power.

Mechanical data

- Case: DO-214AC(SMA), Molded plastic.
- Epoxy: UL 94V-0 rate flame retardant.
- Terminals: Solderable per MIL-STD-750, method 2026.
- Polarity: Color band denotes cathode.
- Mounting position: Any.

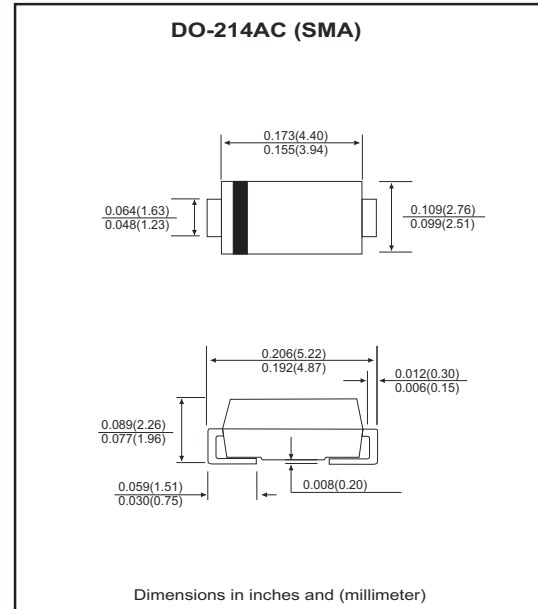

Maximum Rating AND Electrical Characteristics

Parameter	Symbol	Value	Unit
Maximum Power Dissipation, $T_L = 50^\circ\text{C}$ (Note1)	P_D	1.5	W
Maximum Forward voltage at $I_F=200\text{mA}$	V_F	1.2	V
Operating Junction and Storage Temperature Range	T_J, T_{STG}	-55 to +175	$^\circ\text{C}$

(1) T_L = Lead temperature at 3/8" (9.5mm) from body.

RATING AND CHARACTERISTIC CURVES (CZRA5920B-G Thru CZRA5956B-G)

Fig.1 Typical thermal resistance v.s. lead length

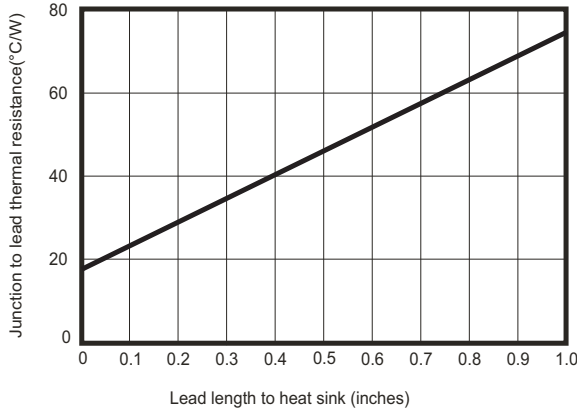

Fig.2 Maximum surge power

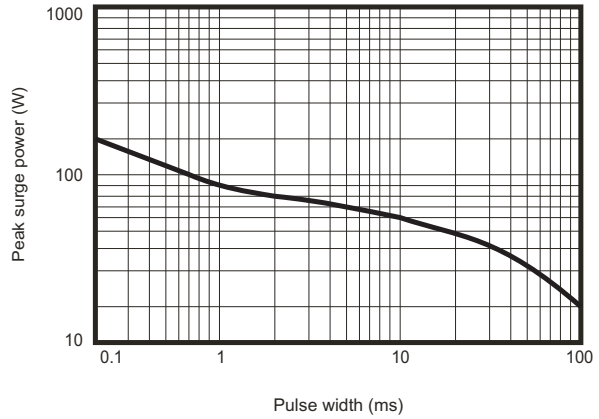

Fig.3 Temperature coefficients v.s. zener voltage

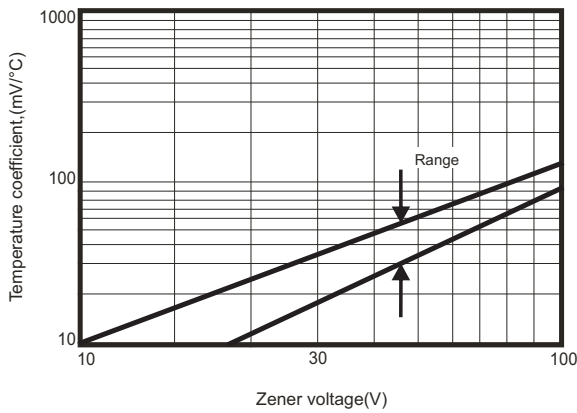

Fig.4 Power temperature derating current

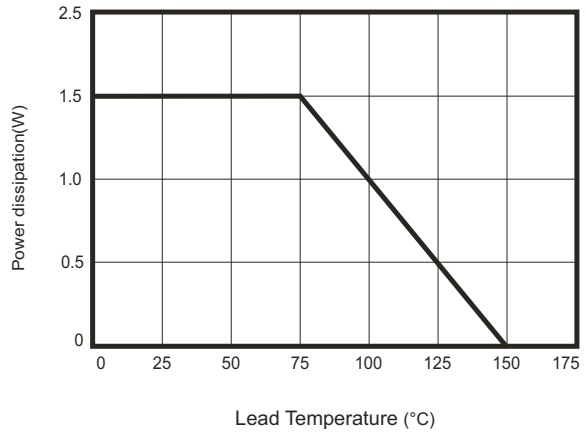
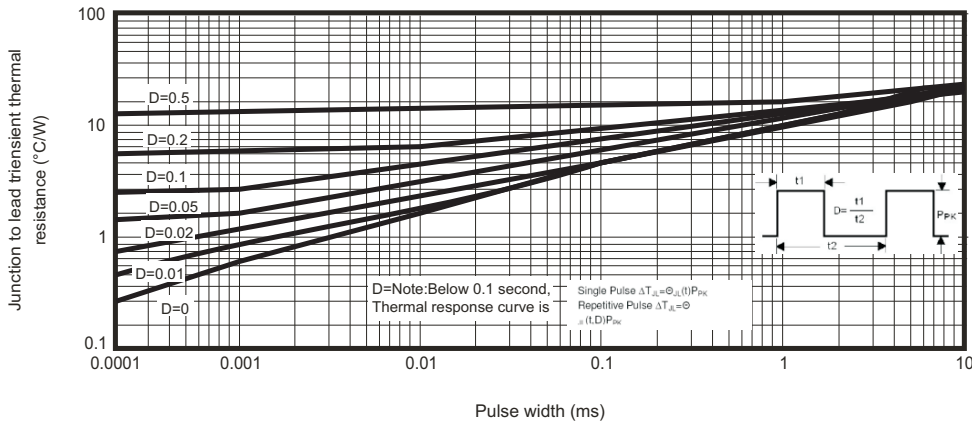

Fig.5 Typical thermal response L, lead length=3/8 inch



Electrical Characteristics(Ta = 25°C)

Part Number	Nominal Zener Voltage		Maximum Zener Impedance			Maximum Reverse Leakage Current		Maximum DC Zener Current	Marking Code
	VZ @ IZT	IZT	ZZT @ IZT	ZZK @ IZK	IZK	IR @ VR		IZM	
	(V)	(mA)	(Ohm)	(Ohm)	(mA)	(uA)	(V)	(mA)	
CZRA5920B-G	6.2	60.5	2.0	200	1.0	5.0	4.0	241	920B
CZRA5921B-G	6.8	55.1	2.5	200	1.0	5.0	5.2	440	921B
CZRA5922B-G	7.5	50.0	3.0	400	0.5	5.0	6.0	400	922B
CZRA5923B-G	8.2	45.7	3.5	400	0.5	5.0	6.5	364	923B
CZRA5924B-G	9.1	41.2	4.0	500	0.5	5.0	7.0	328	924B
CZRA5925B-G	10	37.5	4.5	500	0.25	5.0	8.0	300	925B
CZRA5926B-G	11	34.1	5.5	550	0.25	5.0	8.4	272	926B
CZRA5927B-G	12	31.2	6.5	550	0.25	1.0	9.1	250	927B
CZRA5928B-G	13	28.8	7.0	550	0.25	1.0	9.9	230	928B
CZRA5929B-G	15	25.0	9.0	600	0.25	1.0	11.4	200	929B
CZRA5930B-G	16	23.4	10	600	0.25	1.0	12.2	186	930B
CZRA5931B-G	18	20.8	12	650	0.25	1.0	13.7	166	931B
CZRA5932B-G	20	18.7	14	650	0.25	1.0	15.2	150	932B
CZRA5933B-G	22	17.0	18	650	0.25	1.0	16.7	136	933B
CZRA5934B-G	24	15.6	19	700	0.25	1.0	18.2	124	934B
CZRA5935B-G	27	13.9	23	700	0.25	1.0	20.6	110	935B
CZRA5936B-G	30	12.5	26	750	0.25	1.0	22.8	100	936B
CZRA5937B-G	33	11.4	33	800	0.25	1.0	25.1	90	937B
CZRA5938B-G	36	10.4	38	850	0.25	1.0	27.4	82	938B
CZRA5939B-G	39	9.6	45	900	0.25	1.0	29.7	76	939B
CZRA5940B-G	43	8.7	53	950	0.25	1.0	32.7	68	940B
CZRA5941B-G	47	8.0	67	1000	0.25	1.0	35.8	62	941B
CZRA5942B-G	51	7.3	70	1100	0.25	1.0	38.8	58	942B
CZRA5943B-G	56	6.7	86	1300	0.25	1.0	42.6	52	943B
CZRA5944B-G	62	6.0	100	1500	0.25	1.0	47.1	48	944B
CZRA5945B-G	68	5.5	120	1700	0.25	1.0	51.7	44	945B
CZRA5946B-G	75	5.0	140	2000	0.25	1.0	56.0	40	946B
CZRA5947B-G	82	4.6	160	2500	0.25	1.0	62.2	36	947B
CZRA5948B-G	91	4.1	200	3000	0.25	1.0	69.2	32	948B
CZRA5949B-G	100	3.7	250	3100	0.25	1.0	76.0	30	949B
CZRA5950B-G	110	3.4	300	4000	0.25	1.0	83.6	13	950B
CZRA5951B-G	120	3.1	380	4500	0.25	1.0	91.2	12	951B
CZRA5952B-G	130	2.9	450	5000	0.25	1.0	98.8	11	952B
CZRA5953B-G	150	2.5	600	6000	0.25	1.0	114.0	10	953B
CZRA5954B-G	160	2.3	700	6500	0.25	1.0	121.6	9	954B
CZRA5955B-G	180	2.1	900	7000	0.25	1.0	136.8	8	955B
CZRA5956B-G	200	1.9	1900	9990	0.25	1.0	152.0	7	956B

Notes:

- (1) The type number listed have a standard tolerance on th nominal zener voltage of $\pm 5\%$.
- (2) The reverse surge current is a non-repetitive, 8.3ms pulse width square wave or equivalent sine-wave superimposed on IZT per JEDEC Method.

Reel Taping Specification

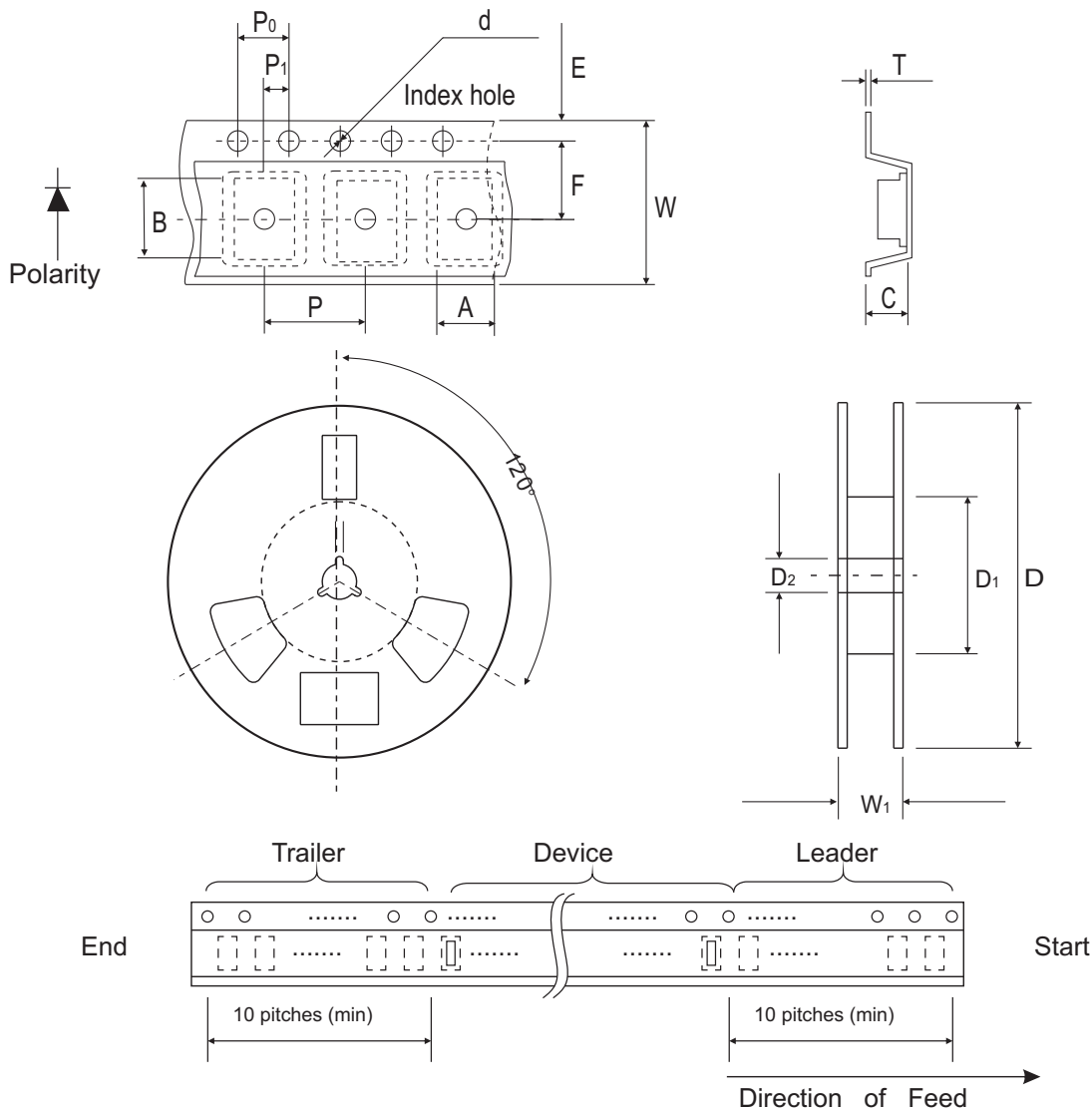

SMA (DO-214AC)	SYMBOL	A	B	C	d	D	D1	D2
	(mm)	2.70 (max)	5.30 (max)	2.66 (max)	1.50 ± 0.10	330	50.0 MIN.	13.5 ± 1.00
	(inch)	0.106 (max)	0.209 (max)	0.105 (max)	0.059 ± 0.004	12.99	1.969 MIN.	0.531 ± 0.039

SMA (DO-214AC)	SYMBOL	E	F	P	P0	P1	W	W1
	(mm)	1.75 ± 0.10	5.50 ± 0.05	4.00 ± 0.10	4.00 ± 0.10	2.00 ± 0.05	12.0 ± 0.20	18.4 (max)
	(inch)	0.689 ± 0.004	0.217 ± 0.002	0.157 ± 0.004	0.157 ± 0.004	0.079 ± 0.002	0.472 ± 0.008	0.724 (max)

Suggested PAD Layout

SIZE	DO-214AC(SMA)	
	(mm)	(inch)
A	3.80	0.150
B	1.60	0.063
C	2.80	0.110
D	5.40	0.213
E	2.20	0.087

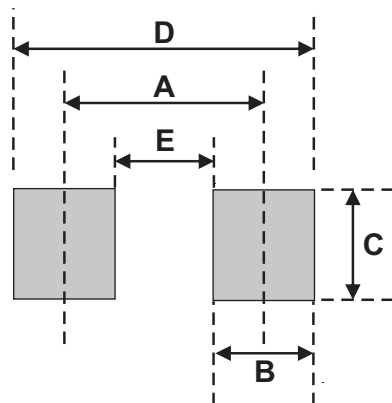

Standard Package

Case Type	Qty per Reel	Reel Size
	(Pcs)	(inch)
DO-214AC (SMA)	5000	13