

Insulator: ABS UL94HB

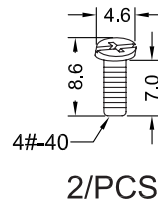

Screw Type Option

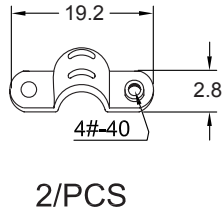
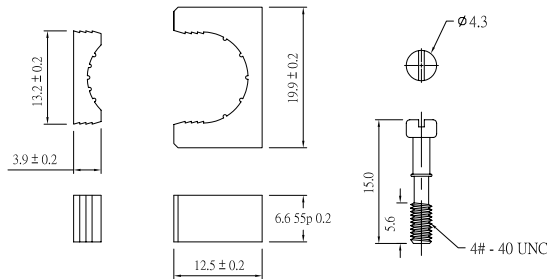
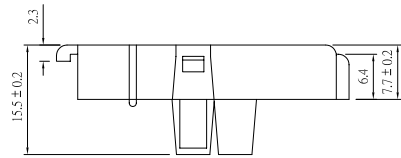
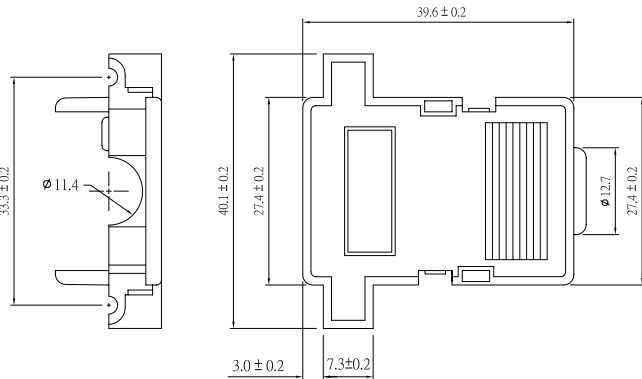
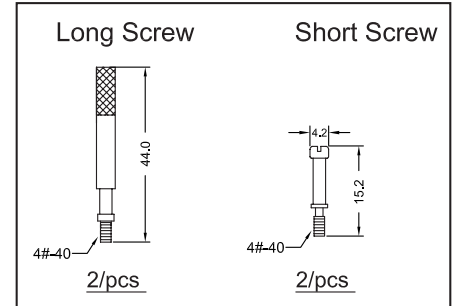

Part Numbering System

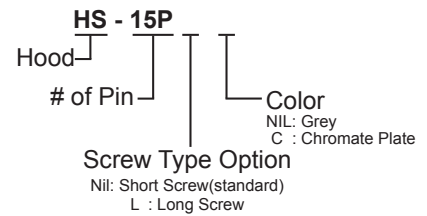

Packaging: 50 Individually sealed pieces per bag.

General Tolerance	
X. ± 0.50	X." ± 5"
.X ± 0.20	.X" ± 2"
.XX ± 0.10	.XX" ± 1"
Units : mm	

Rev. No. : PE05