

NEC**MINIATURE SIGNAL RELAY
MR82 SERIES**

As of May 2007, the MR82 series is being listed as a non-promotional item and is not for use in new designs.

Low power consumption
Non-polarized standard miniature relay

DESCRIPTION

This series is a plastic sealed miniature relay designed to offer completely dust and waterproof package with bifurcated and crossbar contacts for assuring high reliability.

FEATURES

- ™ Low power consumption and non-polarized relay (200 mW)
- ™ Plastic sealed package for flow-soldering process
- ™ Super reliability at signal level

APPLICATIONS

Electronic switching systems, test equipment, LAN systems, modems, facsimile, factory automation systems, audiovisual aids, and other electronic equipment

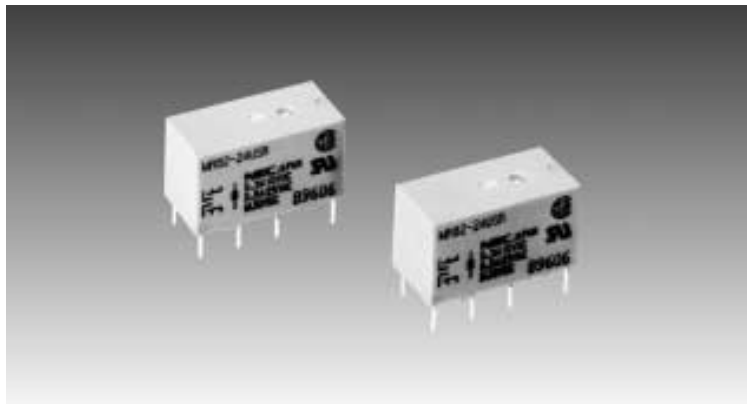
**For Right Use of Miniature Relays****DO NOT EXCEED MAXIMUM RATINGS.**

Do not use relays under exceeding conditions such as over ambient temperature, over voltage and over current. Incorrect use could result in abnormal heating, damage to related parts or cause burning.

READ CAUTIONS IN THE SELECTION GUIDE.

Read the cautions described in NEC's "Miniature Relays" (ER0046EJ ☒) when you choose relays for your application.



PIN CONFIGURATIONS (BOTTOM VIEW)

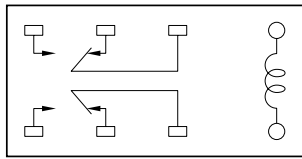

(not energized)

(Note) The coil has no polarity.

PAD LAYOUT Unit : mm (inch)

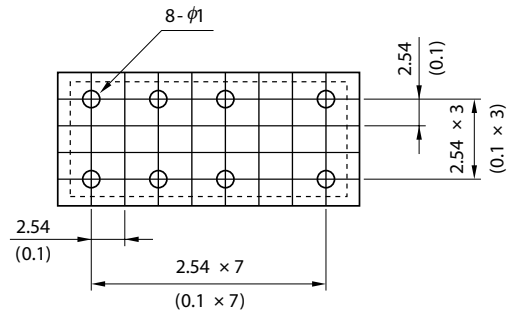

(Note) General tolerance ± 0.2 (0.008) mm

OUTLINE DRAWINGS AND DIMENSIONS Unit : mm (inch)

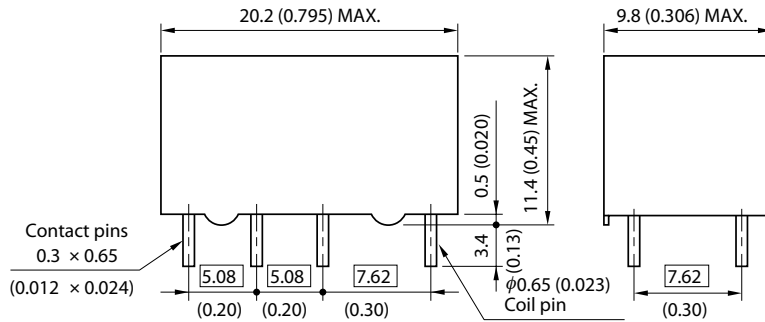

(Note) The tolerance is ± 0.2 (0.008) unless otherwise specified.
The dimension in the box shows basic size.

MARKING (SIDE VIEW)

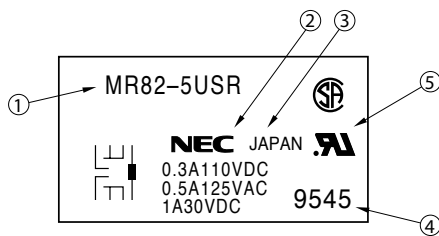

- q Part number
- w Manufacturer
- e Country of origin
- r Date code
- t UL, CSA Marking

SAFETY STANDARD AND RATING

UL Recognized (UL508) * File No. E73266	CSA Certified (CSA C22.2 No 14) File No. LR46266
30 Vdc, 1A (Resistive)	
110 Vdc, 0.3A (Resistive)	
125 Vac, 0.5A (Resistive)	

* Spacing : UL114, UL478

PERFORMANCE CHARACTERISTICS

Contact Form		2 form c
Contact Material		Silver alloy with gold alloy overlay
Contact Ratings	Max. Switching Power	60 W, 125 VA
	Min. Switching Power	100 mVdc, 100 μ A
	Max. Switching Voltage	200 Vdc, 250 Vac
	Max. Switching Current	2 A
	Max. Carrying Current	2 A
Initial Contact Resistance		50 m Ω typ.
Nominal Operating Power		200 mW
Operate Time (Excluding Bounce)		Approx. 5.5 ms without diode (at nominal coil voltage)
Release Time (Excluding Bounce)		Approx. 2 ms without diode (at nominal coil voltage)
Insulation Resistance		Above 1000 M Ω at 500 Vdc
Breakdown Voltage	Between Open Contacts	500 Vac (for one minute)
	Between Adjacent Contacts	1000 Vac (for one minute)
	Between Coil and Contact	1500 V surge (10 \times 160 μ s *1)
Shock Resistance		294 m / s ² (misoperating)
		980 m / s ² (destructive failure)
Vibration Resistance		10 to 55 Hz, at double amplitude of 1.5 mm (misoperating)
		10 to 55 Hz, at double amplitude of 5 mm (destructive failure)
Ambient Temperature		-40 to +85°C
Coil Temperature Rise		Approx. 22°C at nominal coil voltage (200 mW)
Running Specifications	Noload	Above 10 \times 10 ⁶ operations
	Load	50 Vdc 0.1A (resistive) Above 1 \times 10 ⁶ operations at 85°C
		10 Vdc 10 mA(resistive) Above 1 \times 10 ⁶ operations at 85°C
Weight		Approx. 5 grams

*1 rise time : 10 μ s, decay time to half crest : 160 μ s

PART NUMBER SYSTEM

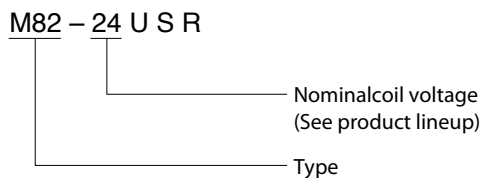

Recommended relay drive conditions

Drive under conditions. If it is impossible, please inquire to NEC.

Nonlatch type	Voltage: within \pm 5% at nominal voltage	Ambient temperature -40 to +85°C
---------------	---	-------------------------------------



WORLD PRODUCTS INC.
ELECTRONIC COMPONENT SOLUTIONS
Automotive • Industrial • Telecom • Wireless

19654 Eighth Street East • Sonoma, CA 95476
707.996.5201 • FAX 707.996.3380
www.worldproducts.com • sales@worldproducts.com

ER0148EJ2V1DS00

PRODUCT LINEUP

at 20 °C

Part Number	Nominal Coil Voltage (Vdc)	Coil Resistance (Ω) \pm 10 %	Must Operate Voltage * (Vdc)	Must Release Voltage * (Vdc)
MR82-4.5USR	4.5	101	3.15	0.23
MR82-5USR	5	125	3.5	0.25
MR82-6USR	6	180	4.2	0.3
MR82-9USR	9	405	6.3	0.45
MR82-12USR	12	720	8.4	0.6
MR82-24USR	24	2880	16.8	1.2

* Test by pulse voltage



WORLD PRODUCTS INC.
ELECTRONIC COMPONENT SOLUTIONS
Automotive • Industrial • Telecom • Wireless

19654 Eighth Street East • Sonoma, CA 95476
707.996.5201 • FAX 707.996.3380
www.worldproducts.com • sales@worldproducts.com

TYPICAL PERFORMANCE DATA

COIL TEMPERATURE RISE

Temperature is measured by coil resistance.

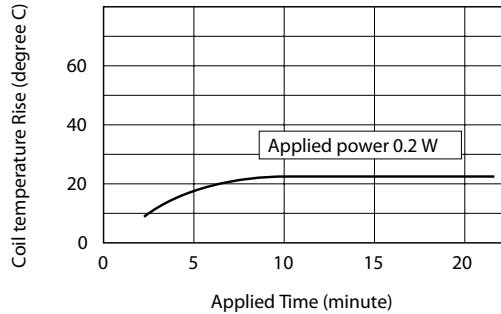
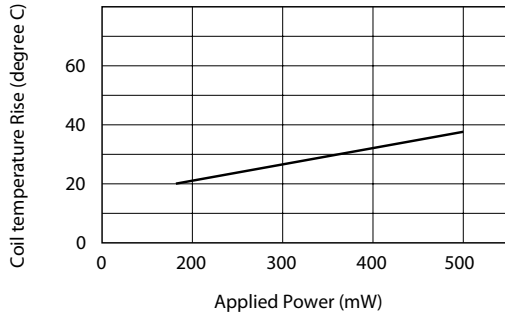

SWITCHING CAPACITY

This is allowed maximum value.

Inquiry for NEC under maximum value at continuous use.

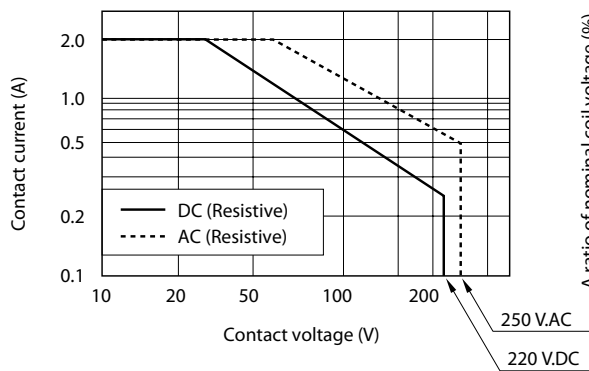

MAXIMUM COIL VOLTAGE

This is maximum value of permissible alteration.

Inquiry for NEC at continuous use.

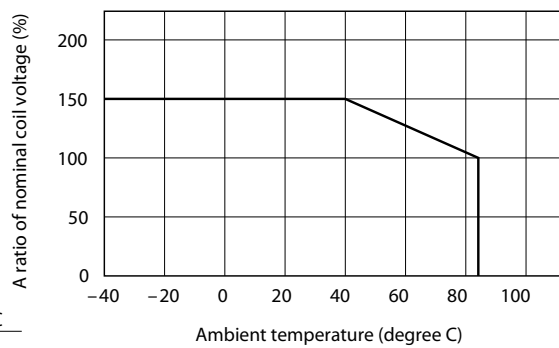

APPLIED VOLTAGE VS. TIMING (Sample: MR82-5USR)

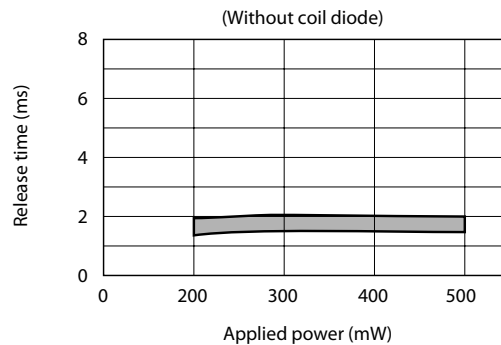
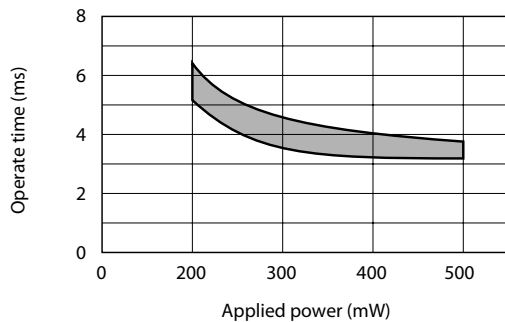

WORLD PRODUCTS INC.
ELECTRONIC COMPONENT SOLUTIONS
Automotive • Industrial • Telecom • Wireless

19654 Eighth Street East • Sonoma, CA 95476
707.996.5201 • FAX 707.996.3380
www.worldproducts.com • sales@worldproducts.com

ER0148EJ2V1DS00

OPERATE AND RELEASE VOLTAGE VS. AMBIENT TEMPERATURE

This shows a typical change of operate (release) voltage. Maximum value of operate estimated, so it must be applied more than this value for safety operation. In case of "hot start operation", please inquiry for NEC.

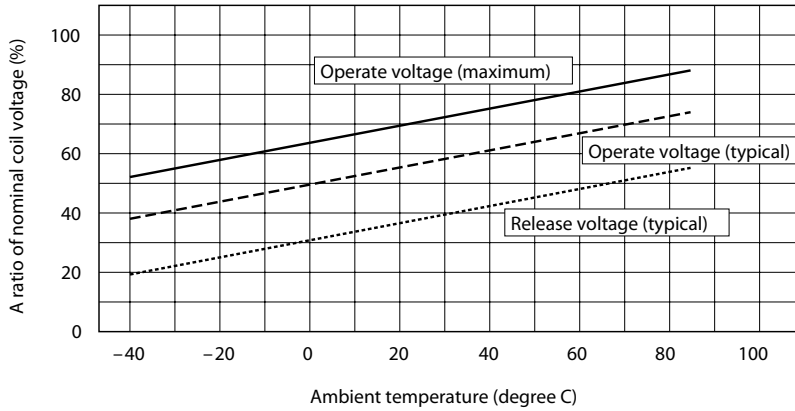

RUNNING TEST (Nonload)

(Load: None, Driving: 5V.DC, 50 Hz, 50% duty, Ambient temperature: Room temperature, Sample: MR82-5USR 20 pieces)

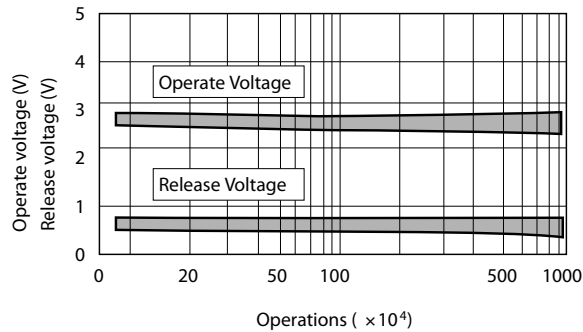
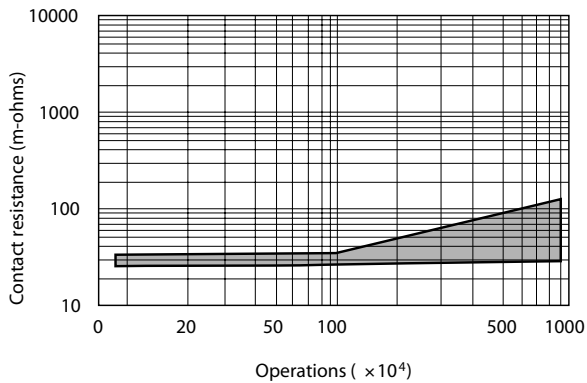

RUNNING TEST (Load)

(Load: 50 V.DC 0.1 A resistive, Driving: 5V.DC, 5 Hz, 50% duty, Ambient temperature: 85 degree C, Sample: MR82-5USR 10 pieces)

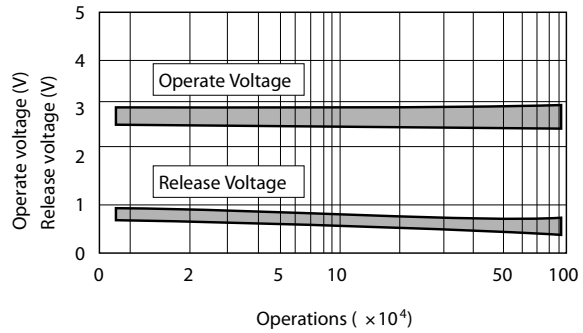
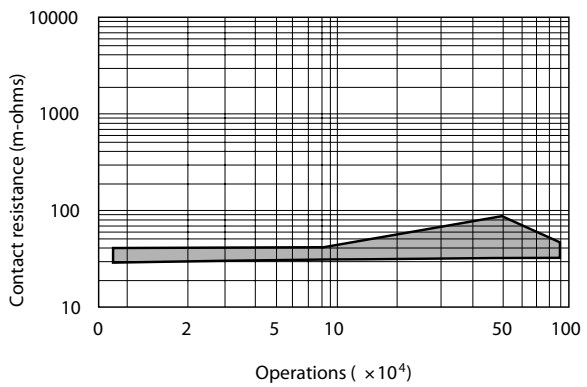

BREAKDOWN VOLTAGE
Sample: MR82-5USR 10 pieces

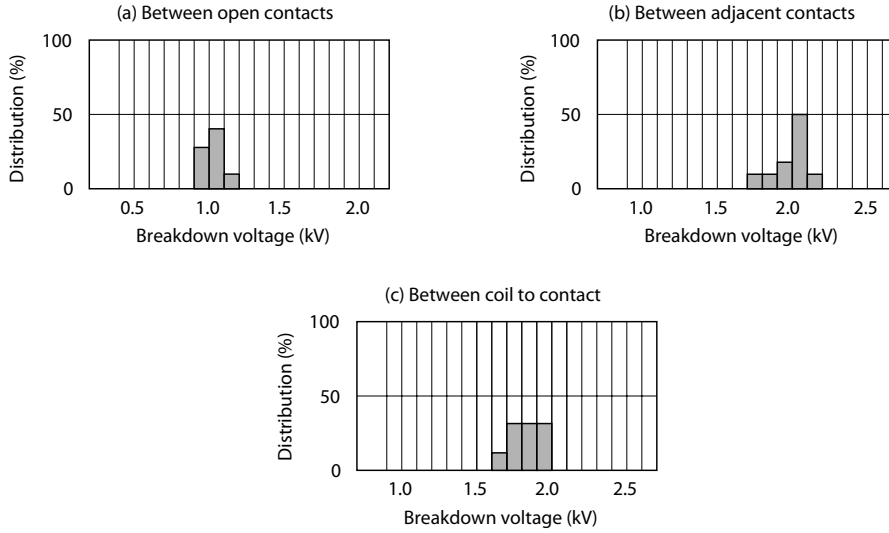

ALTERNATION OF VOLTAGE AT DENSELY MOUNTING (Magnet interference)

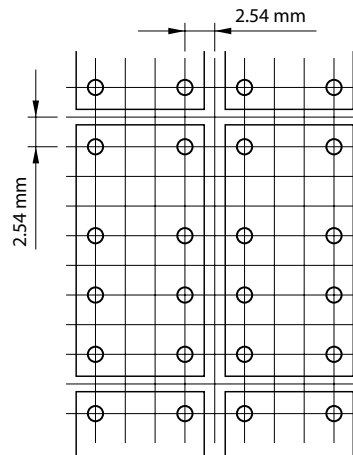
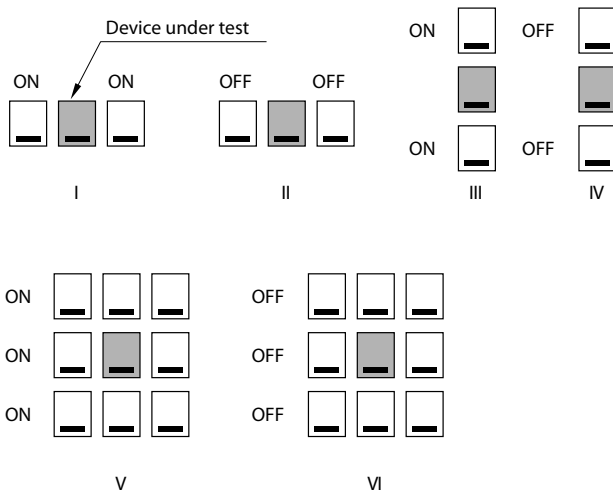
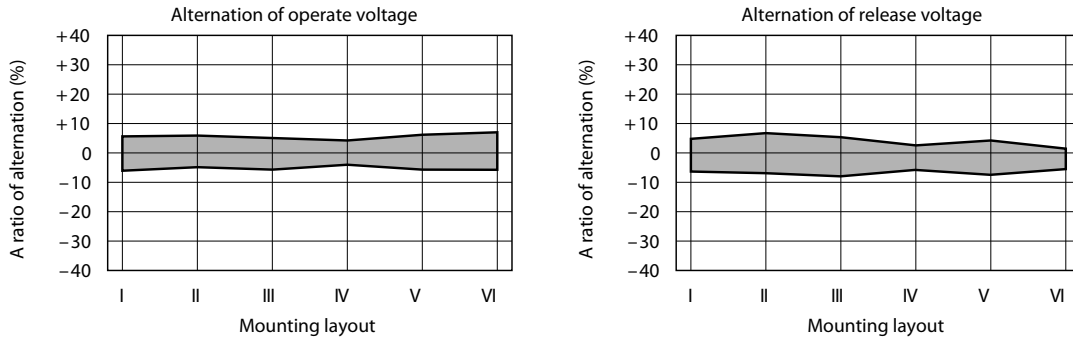

PACKAGE

Dimension of Relay Tube (Unit : mm)

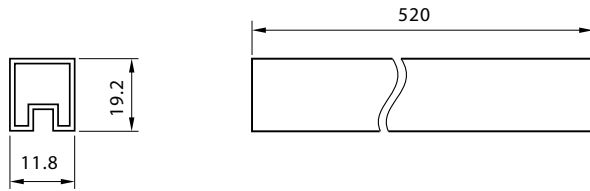

25 pieces / Tube
Material : Polyvinyl chloride
(anti-static treated)

Outline of Package

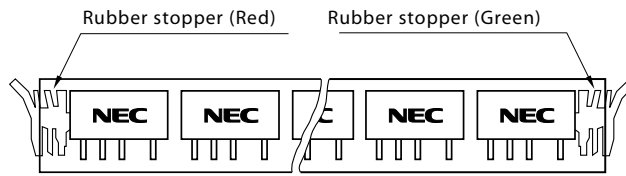

Notes on Correct Use

1. Notes on contact load

Make sure that the contact load is within the specified range; otherwise, the lifetime of the contacts will be shortened considerably. Note that the running performance shown is an example, and that it varies depending on parameters such as the type of load, switching frequency, driver circuit, and ambient temperature under the actual operating conditions. Evaluate the performance by using the actual circuit before using the relay.

2. Driving relays

- If the internal connection diagram of a relay shows + and - symbols on the coil, apply the rated voltage to the relay in the specified direction. If a rippled DC current source is used, abnormalities such as beat at the coil may occur.
- The maximum voltage that can be applied to the coil of the relay varies depending on the ambient temperature. Generally, the higher the voltage applied to the coil, the shorter the operating time. Note, however, that a high voltage also increases the bounce of the contacts and the contact opening and closing frequency, which may shorten the lifetime of the contacts.
- If the driving voltage waveform of the relay coil rises and falls gradually, the inherent performance of the relay may not be fully realized. Make sure that the voltage waveform instantaneously rises and falls as a pulse.

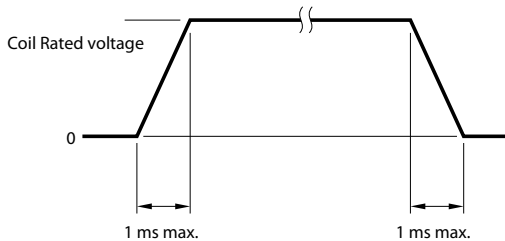

- For a latching relay, apply a voltage to the coil according to the polarity specified in the internal connection diagram of the relay.
- If a current is applied to the coil over a long period of time, the coil temperature rises, promoting generation of organic gas inside the relay, which may result in faulty contacts. In this case, use of a latching relay is recommended.
- The operating time and release time indicate the time required for each contact to close after the voltage has been applied to or removed from the coil. However, because the relay has a mechanical structure, a bounce state exists at the end of the operating and release times. Furthermore, because additional time is required until the contact stabilizes after being in a high-resistance state, care must be taken when using the relay at high speeds.

3. Operating environment

- Make sure that the relay mounted in the application set is used within the specified temperature range. Use of a relay at a temperature outside this range may adversely affect insulation or contact performance.
- If the relay is used for a long period of time in highly humid (RH 85% or higher) environment, moisture may be absorbed into the relay. This moisture may react with the NOx and SOx generated by glow discharges that occur when the contacts

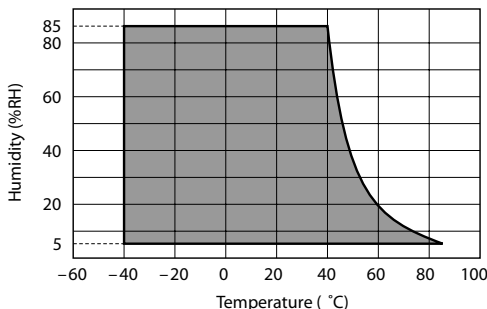

are opened or closed, producing nitric or sulfuric acid. If this happens, the acid produced may corrode the metallic parts of the relay, causing operational malfunction.

- Because the operating temperature range varies depending on the humidity, use the relay in the temperature range illustrated in the figure below. Prevent the relay from being frozen and avoid the generation of condensation.
- The relay maintains constant sealability under normal atmospheric pressure (810 to 1,200 hpa). Its sealability may be degraded or the relay may be deformed and malfunction if it is used under barometric conditions exceeding the specified range.
- The same applies when the relay is stored or transported. Keep the upper-limit value of the temperature to which the relay is exposed after it is removed from the carton box to within 50 °C.
- If excessive vibration or shock is applied to the relay, it may malfunction and the contacts remain closed. Vibration or shock applied to the relay during operation may cause considerable damage to or wearing of the contacts. Note that operation of a snap switch mounted close to the relay or shock due to the operation of magnetic solenoid may also cause malfunctioning.

4. Notes on mounting relays

- When mounting a relay onto a PC board using an automatic chip moulder, if excessive force is applied to the cover of the relay when the relay is chucked or inserted, the cover may be damaged or the characteristics of the relay degraded. Keep the force applied to the relay to within 1 kg.
- Avoid bending the pins to temporarily secure the relay to the PC board. Bending the pins may degrade sealability or adversely affect the internal mechanism.
- It is recommended to solder the relay onto a PC board under the following conditions:
 - <1> Reflow soldering
Refer to the recommended soldering temperature profile.
 - <2> Flow soldering
Solder temperature: 250 °C max., Time: 5 to 10 seconds, Preheating: 100 °C max./1 minute max.
 - <3> Manual soldering
Solder temperature: 350 °C, Time: 2 to 3 seconds
- Ventilation immediately after soldering is recommended. Avoid immersing the relay in cleaning solvent immediately after soldering due to the danger of thermal shock being applied to the relay.
- Use an alcohol-based or water-based cleaning solvent. Never use thinner and benzene because they may damage the relay housing.
- Do not use ultrasonic cleaning because the vibration energy generated by the ultrasonic waves may cause the contacts to remain closed.

5. Handling

- Relays are packaged in magazine cases for shipment. If a space is created in the case after some relays have been removed, be sure to insert a stopper to secure the remaining relays in the case. If relays are not well secured, vibration during transportation may cause malfunctioning of the contacts.
- Exercise care in handling the relay so as to avoid dropping it or allowing it to fall. Do not use a relay that has been dropped. If a relay drops from a workbench to the floor, a shock of 9,800 m/s² (1,000 G) or more is applied to the relay, possibly damaging its functions. Even if a light shock has been applied to the relay, thoroughly evaluate its operation before using it.
- Latching relays are factory-set to the reset state for shipment. A latching relay may be set, however, by vibration or shock applied while being transported. Be sure to forcibly reset the relay before using it in the application set. Also note that the relay may be set by unexpected vibration or shock when it is used in a portable set.
- The sealability of a surface-mount relay may be lost if the relay absorbs moisture and is then heated during soldering. When storing relays, therefore, observe the following points:
 - <1> The storage humidity must be no more than 70% RH. The recommended storage period is 3 months maximum.
 - <2> To store the relay for 3 months or longer, keep the storage humidity to within 50% RH. Do not store the relay for more than 6 months.



WORLD PRODUCTS INC.
ELECTRONIC COMPONENT SOLUTIONS
Automotive • Industrial • Telecom • Wireless

No part of this document may be copied or reproduced in any form or by any means without the prior written consent of NEC Corporation. NEC Corporation assumes no responsibility for any errors which may appear in this document.

NEC Corporation does not assume any liability for infringement of patents, copyrights or other intellectual property rights of third parties by or arising from use of a device described herein or any other liability arising from use of such device. No license, either express, implied or otherwise, is granted under any patents, copyrights or other intellectual property rights of NEC Corporation or others.

While NEC Corporation has been making continuous effort to enhance the reliability of its electronic components, the possibility of defects cannot be eliminated entirely. To minimize risks of damage or injury to persons or property arising from a defect in an NEC electronic component, customers must incorporate sufficient safety measures in its design, such as redundancy, fire-containment, and anti-failure features. NEC devices are classified into the following three quality grades:

"Standard", "Special", and "Specific". The Specific quality grade applies only to devices developed based on a customer designated "quality assurance program" for a specific application. The recommended applications of a device depend on its quality grade, as indicated below. Customers must check the quality grade of each device before using it in a particular application.

Standard: Computers, office equipment, communications equipment, test and measurement equipment, audio and visual equipment, home electronic appliances, machine tools, personal electronic equipment and industrial robots

Special: Transportation equipment (automobiles, trains, ships, etc.), traffic control systems, anti-disaster systems, anti-crime systems, safety equipment and medical equipment (not specifically designed for life support)

Specific: Aircrafts, aerospace equipment, submersible repeaters, nuclear reactor control systems, life support systems or medical equipment for life support, etc.

The quality grade of NEC devices is "Standard" unless otherwise specified in NEC's Data Sheets or Data Books. If customers intend to use NEC devices for applications other than those specified for Standard quality grade, they should contact an NEC sales representative in advance.

(Note)

- (1) "NEC" as used in this statement means NEC Corporation and also includes its majority-owned subsidiaries.
- (2) "NEC electronic component products" means any electronic component product developed or manufactured by or for NEC (as defined above).

DE0202



WORLD PRODUCTS INC.
ELECTRONIC COMPONENT SOLUTIONS
Automotive • Industrial • Telecom • Wireless

19654 Eighth Street East • Sonoma, CA 95476
707.996.5201 • FAX 707.996.3380
www.worldproducts.com • sales@worldproducts.com