

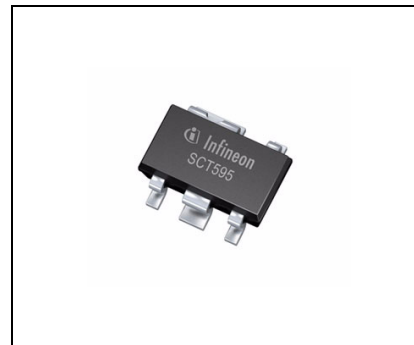

## Features

- Two versions: 3.3 V, 5.0 V
- Output voltage tolerance  $\leq \pm 4\%$
- Very low drop voltage
- Output current: 30 mA
- Inhibit input
- Low quiescent current consumption
- Wide operation range: up to 45 V
- Wide temperature range:  $-40\text{ }^{\circ}\text{C} \leq T_j \leq 150\text{ }^{\circ}\text{C}$
- Output protected against short circuit
- Overtemperature protection
- Reverse polarity proof
- Very small SMD-Package PG-SCT595-5
- Green Product (RoHS compliant)
- AEC Qualified



## Functional Description

The **TLE 4296-2 G** is a monolithic integrated low-drop voltage regulator in the very small SMD package PG-SCT595-5. It is designed to supply e.g. microprocessor systems under the severe conditions of automotive applications. Therefore the device is equipped with additional protection functions against overload, short circuit and reverse polarity. At overtemperature the regulator is automatically turned off by the integrated thermal protection circuit.

Input voltages up to 40 V are regulated to  $V_{Q,nom} = 3.3\text{ V}$  (V33 version) or 5.0 V (V50 version). The output is able to drive a load of more than 30 mA while it regulates the output voltage within a 4% accuracy. To save energy the device can be switched in stand-by mode via an inhibit input which causes the current consumption to drop below 5  $\mu\text{A}$ .

Type	Package
TLE 4296-2 GV33	PG-SCT595-5
TLE 4296-2 GV50	PG-SCT595-5

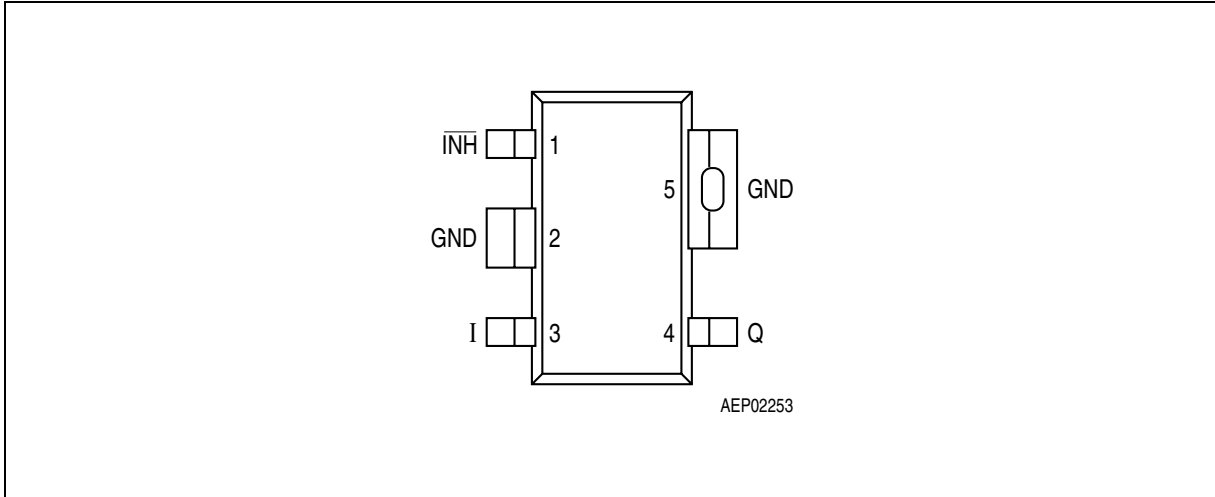

**Figure 1** Pin Configuration (top view)

**Table 1** Pin Definitions and Functions

Pin No.	Symbol	Function
1	$\overline{\text{INH}}$	<b>Inhibit input;</b> high level to turn IC on
2	GND	<b>Ground;</b> connected to pin 5
3	I	<b>Input voltage</b>
4	Q	<b>Output voltage;</b> must be blocked with a ceramic capacitor $C_Q \geq 3.3 \mu\text{F}$ , $\text{ESR} \leq 2 \Omega$
5	GND	<b>Ground;</b> connected to pin 2

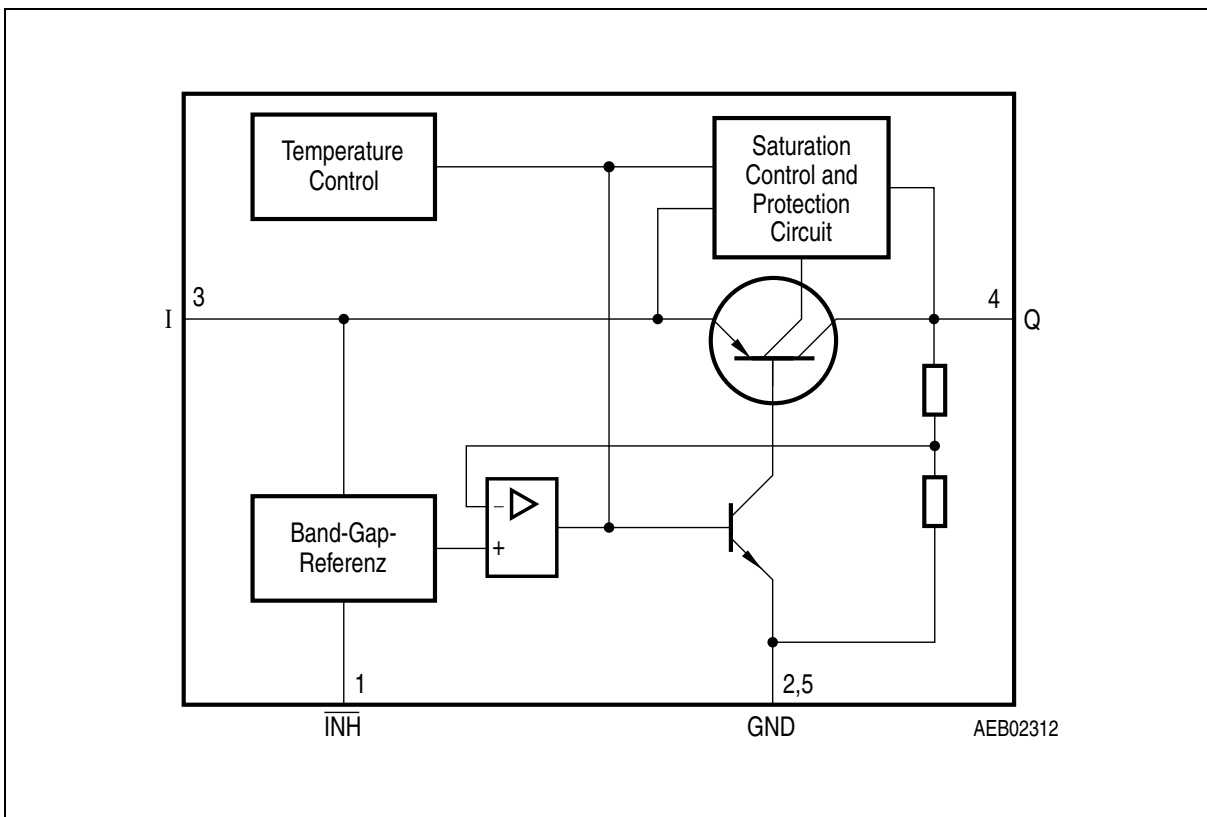

**Figure 2** Block Diagram

**Table 2 Absolute Maximum Ratings**
 $-40\text{ }^{\circ}\text{C} < T_j < 150\text{ }^{\circ}\text{C}$ 

Parameter	Symbol	Limit Values		Unit	Remarks
		Min.	Max.		
<b>Input</b>					
Voltage	$V_I$	-42	45	V	–
Current	$I_I$	–	–	mA	internally limited
<b>Output</b>					
Voltage	$V_Q$	-0.3	30	V	–
Current	$I_Q$	–	–	mA	internally limited
<b>Inhibit</b>					
Voltage	$V_{INH}$	-42	45	V	–
Current	$I_{INH}$	-500	*	$\mu\text{A}$	* internally limited
Current	$I_{INH}$	-5	5	mA	$-0.3\text{ V} < V_I < 45\text{ V};$ $t_p < 1\text{ ms}$
<b>Temperatures</b>					
Junction temperature	$T_j$	-40	150	$^{\circ}\text{C}$	–
Storage temperature	$T_{stg}$	-50	150	$^{\circ}\text{C}$	–
<b>Thermal Resistances</b>					
Junction pin	$R_{thj-pin}$	–	30	K/W	measured to pin 5
Junction ambient <sup>1)</sup>	$R_{thja}$	–	179	K/W	zero airflow zero heat sink area

1) Worst case regarding peak temperature.

*Note: Maximum ratings are absolute ratings; exceeding any one of these values may cause irreversible damage to the integrated circuit.*

**Table 3      Operating Range**

Parameter	Symbol	Limit Values		Unit	Remarks
		Min.	Max.		
Input voltage	$V_I$	4.0	45	V	TLE 4296-2 GV33
	$V_I$	5.5	45	V	TLE 4296-2 GV50
Inhibit voltage	$V_{INH}$	-0.3	40	V	–
Junction temperature	$T_j$	-40	150	°C	–

**Table 4 Electrical Characteristics**
 $V_I = 13.5 \text{ V}; V_{\text{INH}} > +2.5 V_Q; -40 \text{ }^\circ\text{C} < T_j < 150 \text{ }^\circ\text{C};$  unless otherwise specified

Parameter	Symbol	Limit Values			Unit	Test Condition
		Min.	Typ.	Max.		
Output voltage V33 version	$V_Q$	3.17	3.30	3.43	V	$1 \text{ mA} < I_Q < 30 \text{ mA}$ $V_I = 13.5 \text{ V}$
		3.17	3.30	3.43	V	$I_Q = 10 \text{ mA}$ $4.3 \text{ V} < V_I < 40 \text{ V}$
Output voltage V50 version	$V_Q$	4.80	5.00	5.20	V	$1 \text{ mA} < I_Q < 30 \text{ mA}$ $V_I = 13.5 \text{ V}$
		4.80	5.00	5.20	V	$I_Q = 10 \text{ mA}$ $6 \text{ V} < V_I < 40 \text{ V}$
Output current limitation	$I_Q$	30	–	–	mA	<sup>1)</sup>
Drop voltage	$V_{\text{dr}}$	–	0.25	0.30	V	$I_Q = 20 \text{ mA}^{\text{1)}$
Output capacitor	$C_Q$	3.3	–	–	$\mu\text{F}$	$\text{ESR} \leq 2 \Omega$ at 10 kHz
Current consumption $I_q = I_I - I_Q$	$I_q$	–	2	5.2	mA	$I_Q < 30 \text{ mA}$
Current consumption $I_q = I_I - I_Q$	$I_q$	–	130	170	$\mu\text{A}$	$I_Q < 0.1 \text{ mA};$ $T_j < 85 \text{ }^\circ\text{C}$
Quiescent current (stand-by) $I_q = I_I - I_Q$	$I_q$	–	0	1	$\mu\text{A}$	$V_{\text{INH}} = 0.4 \text{ V};$ $T_j < 85 \text{ }^\circ\text{C}$
Quiescent current (stand-by) $I_q = I_I - I_Q$	$I_q$	–	0	5	$\mu\text{A}$	$V_{\text{INH}} = 0.4 \text{ V}$

**Table 4 Electrical Characteristics (cont'd)**
 $V_I = 13.5 \text{ V}; V_{\overline{\text{INH}}} > +2.5 V_Q; -40 \text{ }^\circ\text{C} < T_j < 150 \text{ }^\circ\text{C};$  unless otherwise specified

Parameter	Symbol	Limit Values			Unit	Test Condition
		Min.	Typ.	Max.		
Load regulation	$\Delta V_Q$	–	17	50	mV	$1 \text{ mA} < I_Q < 25 \text{ mA};$ $T_j = 25 \text{ }^\circ\text{C}$ TLE 4296-2 GV50
		–	14	40	mV	$1 \text{ mA} < I_Q < 25 \text{ mA};$ $T_j = 25 \text{ }^\circ\text{C}$ TLE 4296-2 GV33
Line regulation	$\Delta V_Q$	–	10	25	mV	$V_I = (V_{Q,\text{nom}} + 0.5 \text{ V})$ to 36 V $I_Q = 5 \text{ mA}; T_j = 25 \text{ }^\circ\text{C}$
Power Supply Ripple Rejection	<i>PSRR</i>	–	60	–	dB	$f_r = 100 \text{ Hz};$ $V_r = 0.5 \text{ Vpp}$

**Logic Inhibit Input**

Inhibit, Turn-on voltage	$V_{\overline{\text{INH}}, \text{high}}$	–	–	2.2	V	$V_Q > 0.95 V_{Q,\text{nom}}$
Inhibit, Turn-off voltage	$V_{\overline{\text{INH}}, \text{low}}$	0.4	–	–	V	$V_Q > 0.1 \text{ V}$
H-input current	$I_{\overline{\text{INH}}, \text{high}}$	–	8	12	$\mu\text{A}$	$V_{\overline{\text{INH}}} = 5 \text{ V}$
L-input current	$I_{\overline{\text{INH}}, \text{low}}$	-2	–	2	$\mu\text{A}$	$V_{\overline{\text{INH}}} = 0 \text{ V}$

 1) Measured when the output voltage  $V_Q$  has dropped 100 mV from the nominal value.

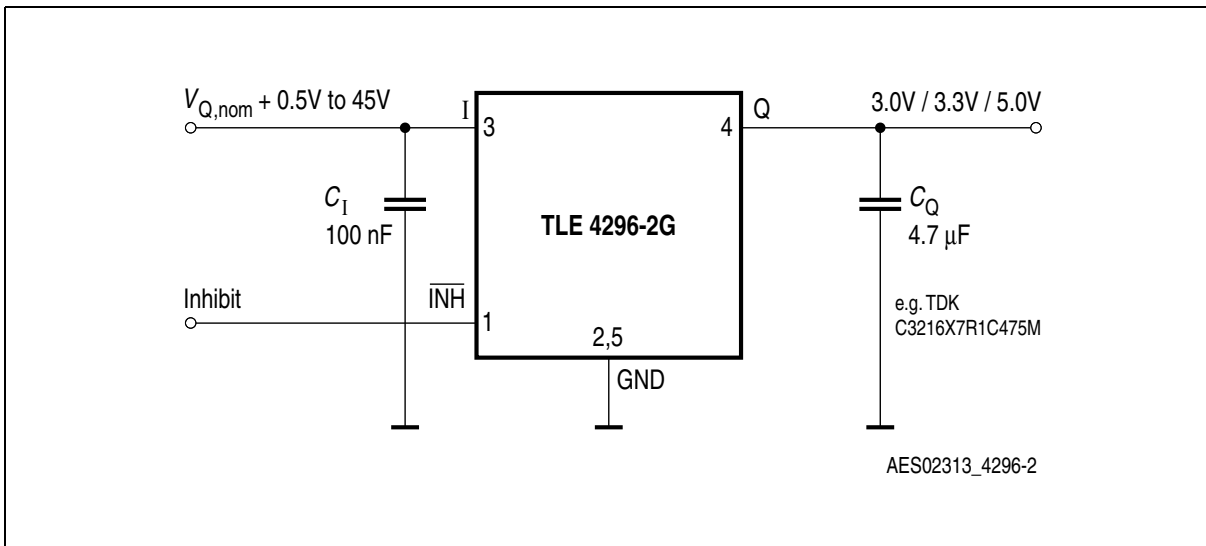

**Figure 3 Application Circuit**

### Application Information

In the TLE 4296-2 G the output voltage is divided and compared to an internal reference of 2.5 V typical. The regulation loop controls the output to achieve a stabilized output voltage.

**Figure 3** shows a typical application circuit. In order to maintain the stability of the control loop the TLE 4296-2 G output requires an output capacitor  $C_Q$  of at least 3.3  $\mu\text{F}$  with a maximum permissible ESR of 2  $\Omega$ . It is recommended to use a multi layer ceramic capacitor for  $C_Q$ , e.g. the TDK C3216X7R1C475M with a nominal capacitance of 4.7  $\mu\text{F}$ . Aluminum electrolytic as well as tantalum capacitors do not cover the required ESR range over the full operating temperature range of -40  $^{\circ}\text{C}$  to 150  $^{\circ}\text{C}$ .

At the input of the regulator an input capacitor is necessary for compensating line influences (100 nF ceramic capacitor recommended). A resistor of approx. 1  $\Omega$  in series with  $C_I$ , can damp any oscillation occurring due the input inductivity and the input capacitor. If the regulator is sourced via long input lines of several meters it is recommended to place an additional electrolytic capacitor  $\geq 47 \mu\text{F}$  at the input.



### Typical Performance Characteristics

**Output Voltage  $V_Q$  versus Input Voltage  $V_I$**

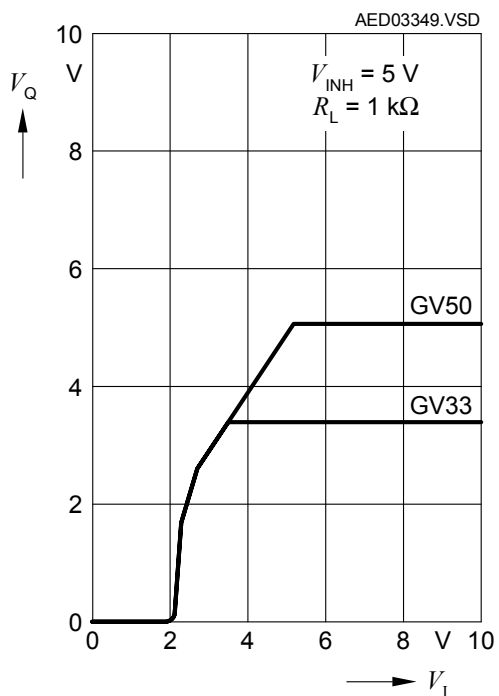

**Current Consumption  $I_q$  versus Input Voltage  $V_I$**

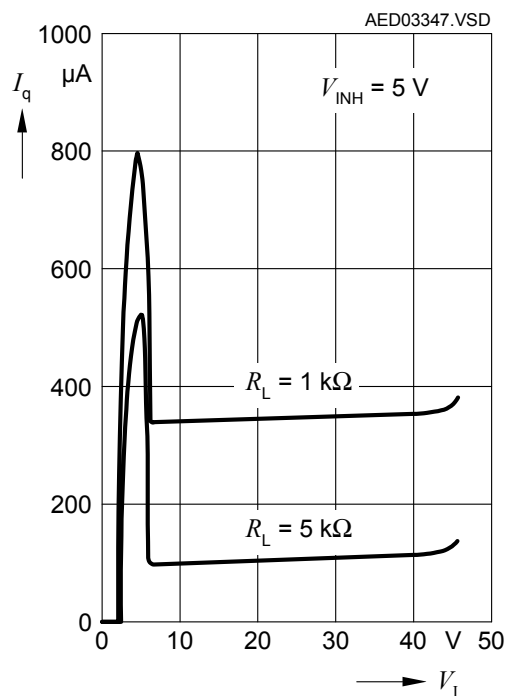

Package Outlines

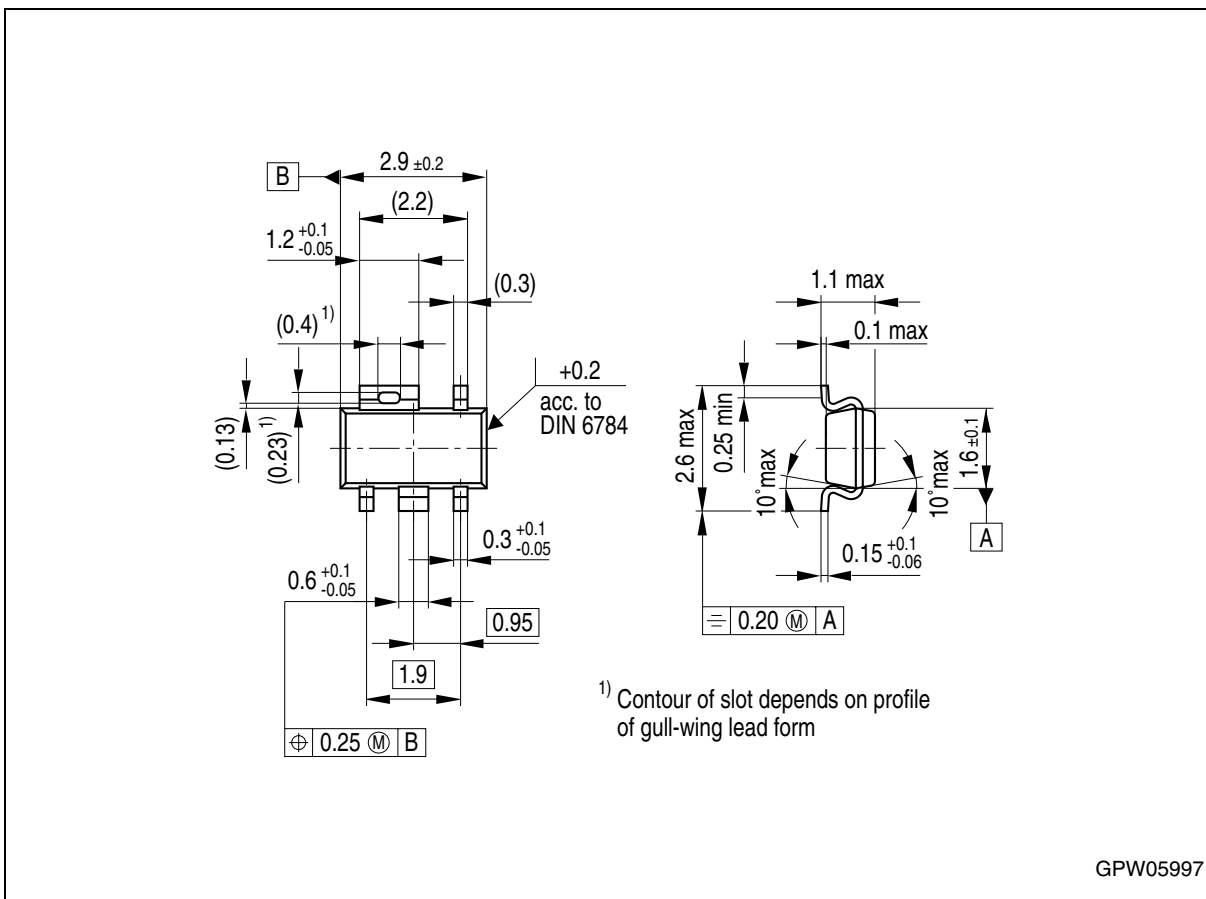

Figure 4 PG-SCT595-5 (Plastic Small Outline)

**Green Product (RoHS compliant)**

To meet the world-wide customer requirements for environmentally friendly products and to be compliant with government regulations the device is available as a green product. Green products are RoHS-Compliant (i.e Pb-free finish on leads and suitable for Pb-free soldering according to IPC/JEDEC J-STD-020).

For further information on alternative packages, please visit our website:  
<http://www.infineon.com/packages>.

Dimensions in mm

## Revision History

Version	Date	Changes
Rev. 1.1	2008-01-28	Initial version of RoHS-compliant derivate of TLE 4296-2 <b>Page 1</b> : AEC certified statement added. <b>Page 1</b> and <b>Page 10</b> : RoHS compliance statement and Green product feature added. <b>Page 1</b> and <b>Page 10</b> : Package changed to RoHS compliant version. Legal Disclaimer updated
Rev. 1.0	2004-01-01	Final datasheet

**Edition 2008-01-28**

**Published by  
Infineon Technologies AG  
81726 Munich, Germany**

**© 2008 Infineon Technologies AG  
All Rights Reserved.**

#### **Legal Disclaimer**

The information given in this document shall in no event be regarded as a guarantee of conditions or characteristics. With respect to any examples or hints given herein, any typical values stated herein and/or any information regarding the application of the device, Infineon Technologies hereby disclaims any and all warranties and liabilities of any kind, including without limitation, warranties of non-infringement of intellectual property rights of any third party.

#### **Information**

For further information on technology, delivery terms and conditions and prices, please contact the nearest Infineon Technologies Office ([www.infineon.com](http://www.infineon.com)).

#### **Warnings**

Due to technical requirements, components may contain dangerous substances. For information on the types in question, please contact the nearest Infineon Technologies Office.

Infineon Technologies components may be used in life-support devices or systems only with the express written approval of Infineon Technologies, if a failure of such components can reasonably be expected to cause the failure of that life-support device or system or to affect the safety or effectiveness of that device or system. Life support devices or systems are intended to be implanted in the human body or to support and/or maintain and sustain and/or protect human life. If they fail, it is reasonable to assume that the health of the user or other persons may be endangered.