

UNCONTROLLED DOCUMENT

\* PATENT PENDING

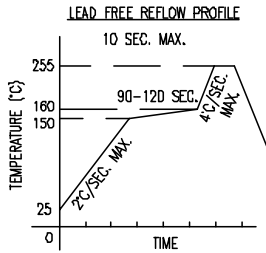

TOTAL TIME ABOVE 220°C IS 60 SECONDS MAX.

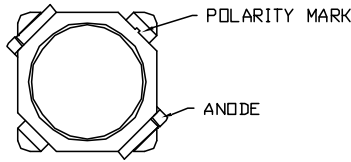
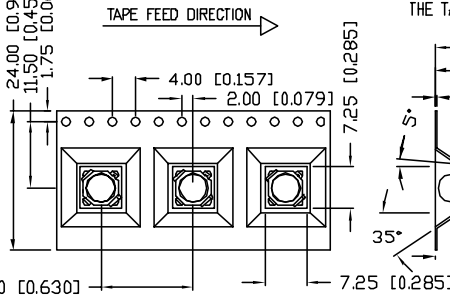
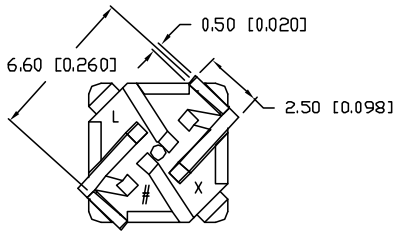
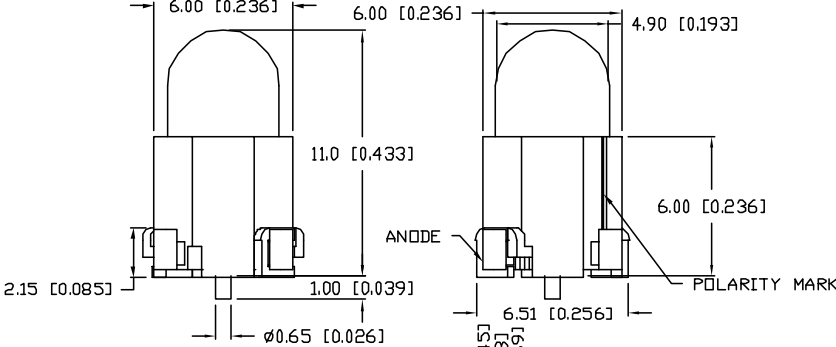

NOTE:  
1. CATHODE IS ORIENTED TOWARDS THE TAPE SPROCKET HOLES.

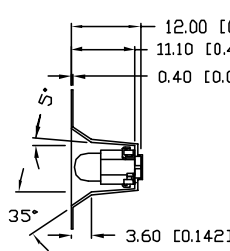

RECOMMENDED PAD LAYOUT

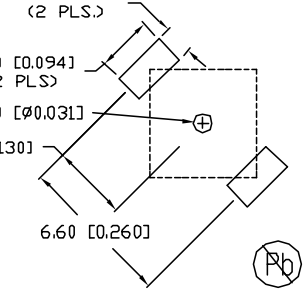

UNCONTROLLED DOCUMENT

\*UNLESS OTHERWISE SPECIFIED TOLERANCES PER DECIMAL PRECISION ARE: X=±1 (±0.039), XX=±0.5 (±0.020), XXX=±0.25 (±0.010), XXXX=±0.127 (±0.005). LEAD SIZE=±0.05 (±0.002), LEAD LENGTH=±0.75 (±0.030). MIN=-0.000. MAX.=+0.000. DECIMAL PRECISION. DECIMAL PRECISION.

PART NUMBER  
SML-H1505SOD-TR

REV.

ELECTRO-OPTICAL CHARACTERISTICS T <sub>A</sub> =25°C I <sub>f</sub> =20mA					
PARAMETER	MIN	TYP	MAX	UNITS	TEST COND
PEAK WAVELENGTH		610		nm	
FORWARD VOLTAGE		2.1	2.6	V <sub>f</sub>	
REVERSE VOLTAGE	5.0			V <sub>r</sub>	I <sub>f</sub> =100µA
AXIAL INTENSITY		1000		mcd	I <sub>f</sub> =20mA
VIEWING ANGLE		75		2x theta	
EMITTED COLOR:	ORANGE				
EPOXY LENS FINISH:	ORANGE DIFFUSED				

LIMITS OF SAFE OPERATION AT 25°C PER DIE		
PARAMETER	MAX	UNITS
PEAK FORWARD CURRENT*	100	mA
STEADY CURRENT	30	mA
POWER DISSIPATION	90	mW
DERATE FROM 25°C	-1.2	mW/°C
OPERATING TEMP.	-30 TO +80	°C
STORAGE TEMP.	-40 TO +100	°C
SOLDERING TEMP.	+260	°C
2.0mm FROM BODY		5 SEC. MAX
*T<10µS		

REV.	PART NUMBER SML-H1505SOD-TR
------	--------------------------------

CONFIDENTIAL INFORMATION  
THE INFORMATION CONTAINED IN THIS DOCUMENT IS THE PROPERTY OF LUMEX INC. EXCEPT AS SPECIFICALLY AUTHORIZED IN WRITING BY LUMEX INC., THE HOLDER OF THIS DOCUMENT SHALL KEEP ALL INFORMATION CONTAINED HEREIN CONFIDENTIAL AND SHALL PROTECT SAME IN WHOLE OR IN PART FROM DISCLOSURE AND DISSEMINATION TO ALL THIRD PARTIES.



290 E. HELEN ROAD  
PALATINE, IL 60067-6976  
PHONE: +1.847.359.2790  
US WEB: www.lumex.com  
TW WEB: www.lumex.com.tw

5mm SURFACE MOUNTED DOME LED,  
610nm SUPER ORANGE LED, ORANGE DIFFUSED.

RELIABILITY NOTE  
OUR MANY YEARS OF EXPERIENCE DATA ACCUMULATION INDICATE THAT SOLDER HEAT IS A MAJOR CAUSE OF EARLY AND FUTURE FAILURE. PLEASE PAY ATTENTION TO YOUR SOLDERING PROCESS.

DRAWN BY: JN	CHECKED BY:	APPROVED BY:	DATE: 03.12.08 PAGE: 1 OF 1 SCALE: N/A
-----------------	-------------	--------------	--