

P-Channel 12-V (D-S) MOSFET

PRODUCT SUMMARY		
V_{DS} (V)	$r_{DS(on)}$ (Ω)	I_D (A)
-12	0.085 @ $V_{GS} = -4.5$ V	-3.3
	0.115 @ $V_{GS} = -2.5$ V	-2.9
	0.160 @ $V_{GS} = -1.8$ V	-2.4

FEATURES

- TrenchFET® Power MOSFETS: 1.8-V Rated
- ESD Protected: 3000 V
- Thermally Enhanced SC-70 Package

APPLICATIONS

- Load Switching
- PA Switch
- Level Switch

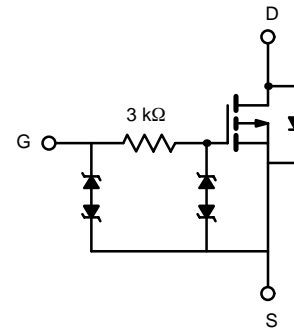
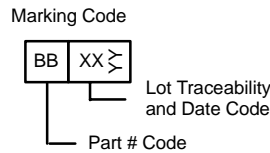
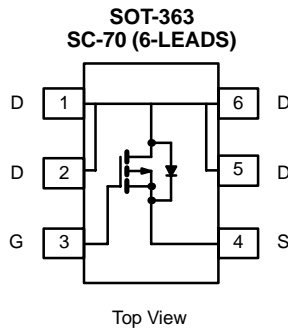

ABSOLUTE MAXIMUM RATINGS ($T_A = 25^\circ\text{C}$ UNLESS OTHERWISE NOTED)					
Parameter	Symbol	5 secs	Steady State	Unit	
Drain-Source Voltage	V_{DS}	-12		V	
Gate-Source Voltage	V_{GS}	± 12			
Continuous Drain Current ($T_J = 150^\circ\text{C}$) ^a	I_D	$T_A = 25^\circ\text{C}$	-3.3	-2.7	A
		$T_A = 85^\circ\text{C}$	-2.4	-1.9	
Pulsed Drain Current	I_{DM}	-8			
Continuous Diode Current (Diode Conduction) ^a	I_S	-1.4	-0.9		
Maximum Power Dissipation ^a	P_D	$T_A = 25^\circ\text{C}$	1.56	1.0	W
		$T_A = 85^\circ\text{C}$	0.81	0.52	
Operating Junction and Storage Temperature Range	T_J, T_{stg}	-55 to 150		$^\circ\text{C}$	

THERMAL RESISTANCE RATINGS					
Parameter	Symbol	Typical	Maximum	Unit	
Maximum Junction-to-Ambient ^a	R_{thJA}	$t \leq 5$ sec	60	80	$^\circ\text{C/W}$
		Steady State	100	125	
Maximum Junction-to-Foot (Drain)	R_{thJF}	34	45		

Notes

a. Surface Mounted on 1" x 1" FR4 Board.

SPECIFICATIONS ($T_J = 25^\circ\text{C}$ UNLESS OTHERWISE NOTED)

Parameter	Symbol	Test Condition	Min	Typ	Max	Unit
Static						
Gate Threshold Voltage	$V_{GS(th)}$	$V_{DS} = V_{GS}, I_D = -250\ \mu\text{A}$	-0.45			V
Gate-Body Leakage	I_{GSS}	$V_{DS} = 0\ \text{V}, V_{GS} = \pm 4.5\ \text{V}$			± 1.5	μA
		$V_{DS} = 0\ \text{V}, V_{GS} = \pm 12\ \text{V}$			± 10	mA
Zero Gate Voltage Drain Current	I_{DSS}	$V_{DS} = -9.6\ \text{V}, V_{GS} = 0\ \text{V}$			-1	μA
		$V_{DS} = -9.6\ \text{V}, V_{GS} = 0\ \text{V}, T_J = 85^\circ\text{C}$			-5	
On-State Drain Current ^a	$I_{D(on)}$	$V_{DS} = -5\ \text{V}, V_{GS} = -4.5\ \text{V}$	-4			A
Drain-Source On-State Resistance ^a	$r_{DS(on)}$	$V_{GS} = -4.5\ \text{V}, I_D = -3.3\ \text{A}$		0.070	0.085	Ω
		$V_{GS} = -2.5\ \text{V}, I_D = -2.9\ \text{A}$		0.095	0.115	
		$V_{GS} = -1.8\ \text{V}, I_D = -1.0\ \text{A}$		0.133	0.160	
Forward Transconductance ^a	g_{fs}	$V_{DS} = -10\ \text{V}, I_D = -3.3\ \text{A}$		8		S
Diode Forward Voltage ^a	V_{SD}	$I_S = -1.4\ \text{A}, V_{GS} = 0\ \text{V}$		-0.80	-1.1	V
Dynamic^b						
Total Gate Charge	Q_g	$V_{DS} = -6\ \text{V}, V_{GS} = -4.5\ \text{V}, I_D = -3.3\ \text{A}$		5.8	8	nC
Gate-Source Charge	Q_{gs}			1.3		
Gate-Drain Charge	Q_{gd}			1.5		
Turn-On Delay Time	$t_{d(on)}$	$V_{DD} = -6\ \text{V}, R_L = 6\ \Omega$ $I_D \cong -1\ \text{A}, V_{GEN} = -4.5\ \text{V}, R_G = 6\ \Omega$		0.60	1.0	μs
Rise Time	t_r			1.4	2.1	
Turn-Off Delay Time	$t_{d(off)}$			4.9	7.5	
Fall Time	t_f			4.9	7.5	

Notes

- a. Pulse test; pulse width $\leq 300\ \mu\text{s}$, duty cycle $\leq 2\%$.
 b. Guaranteed by design, not subject to production testing.

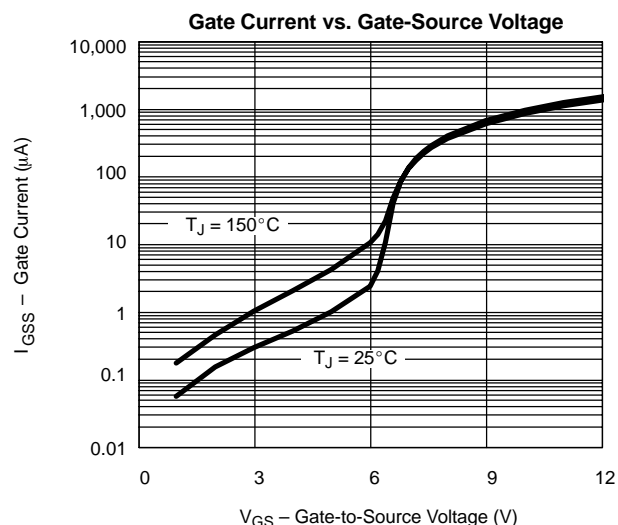
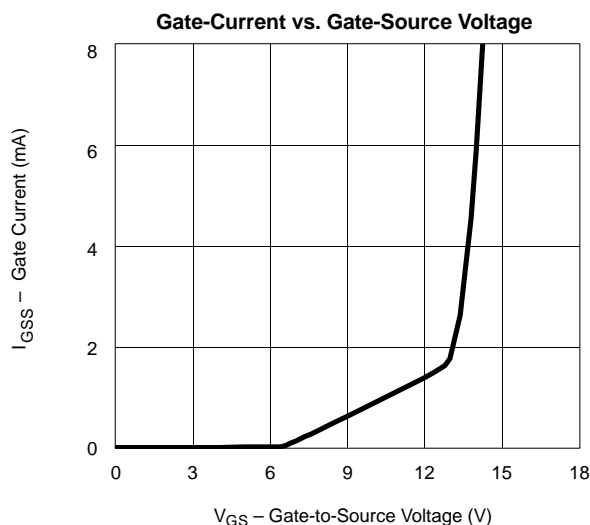
TYPICAL CHARACTERISTICS (25°C UNLESS NOTED)



TYPICAL CHARACTERISTICS (25°C UNLESS NOTED)

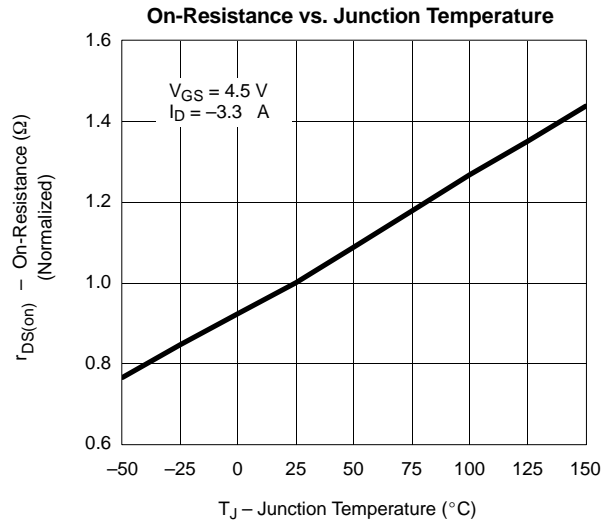
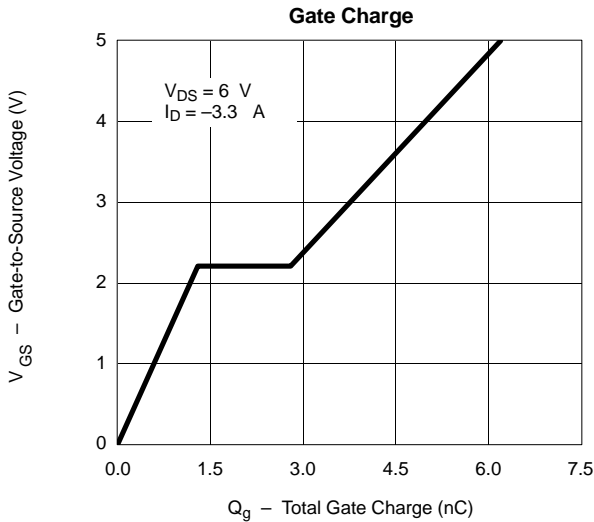
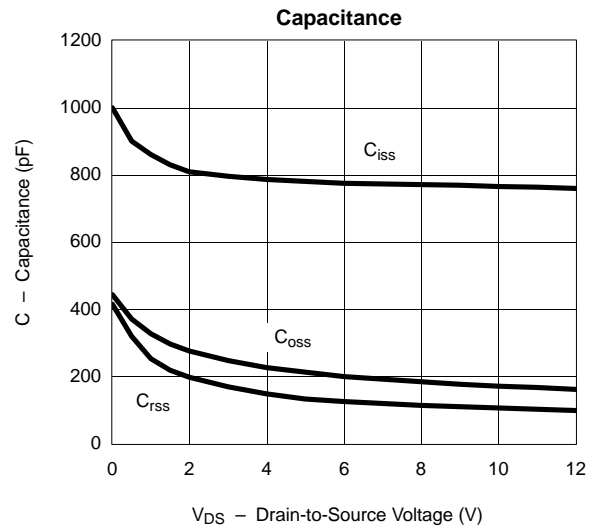
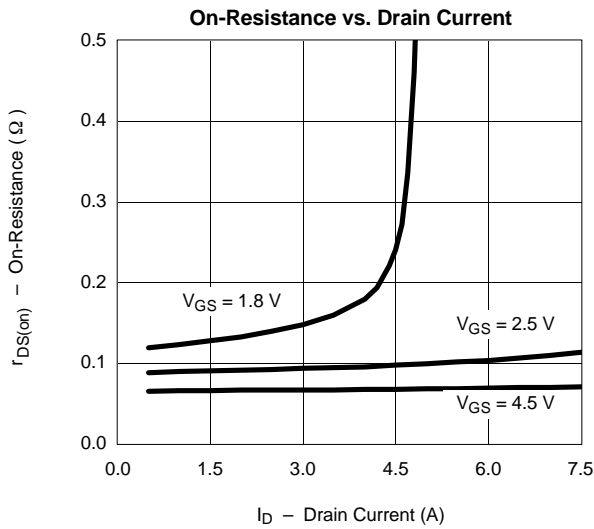
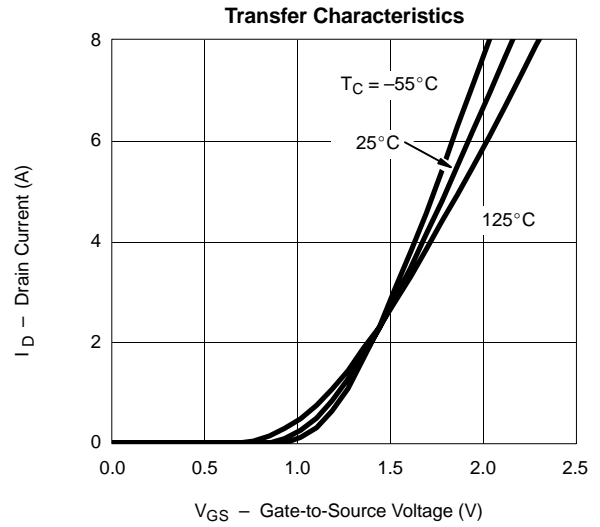
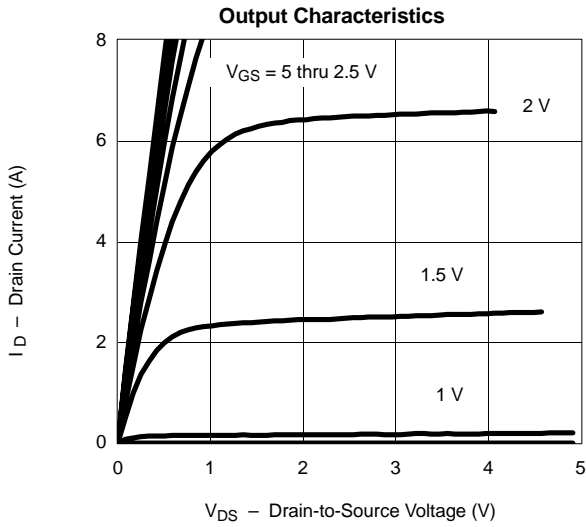

TYPICAL CHARACTERISTICS (25 °C UNLESS NOTED)

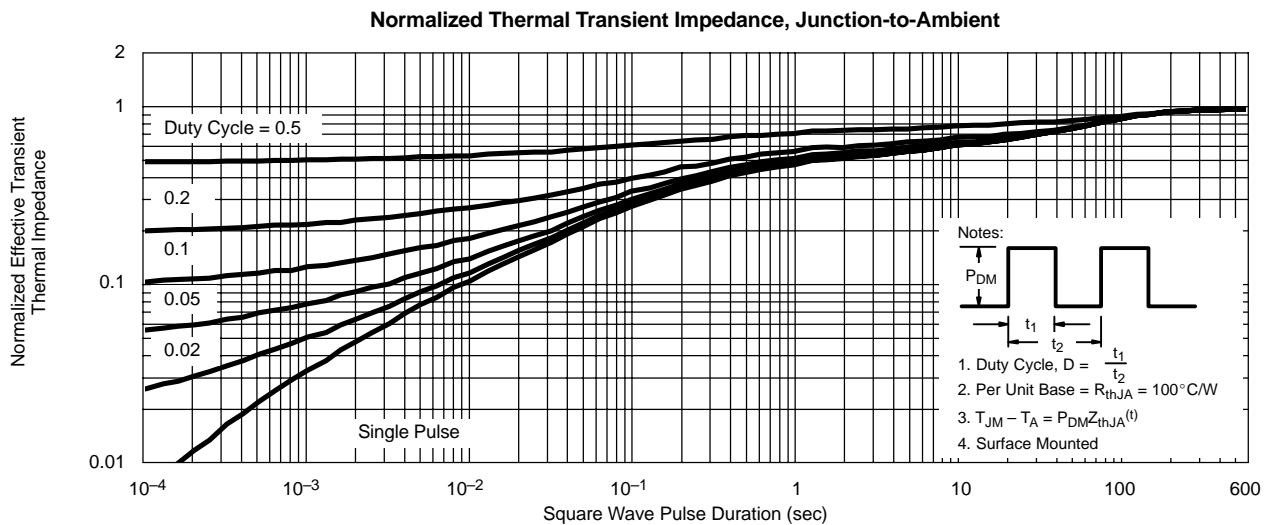
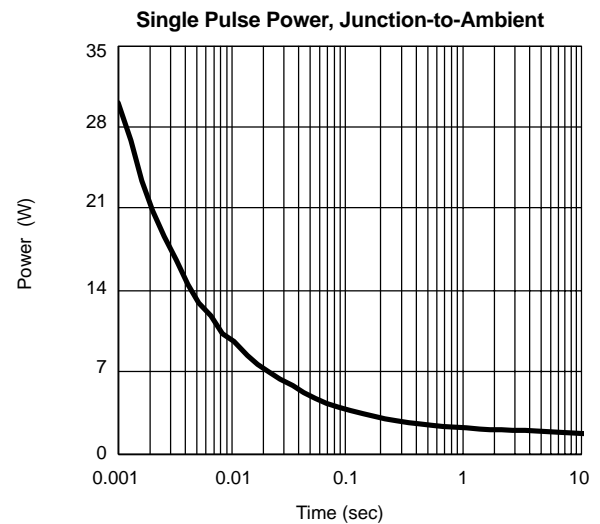
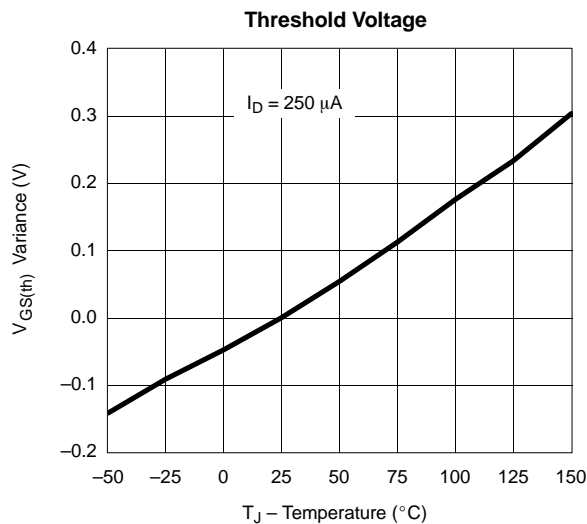
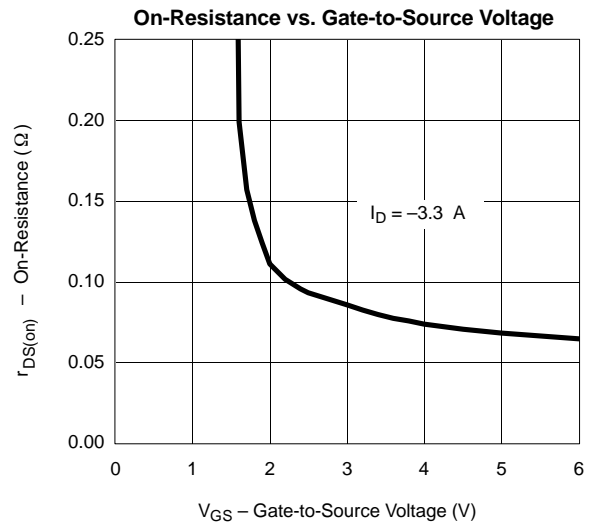
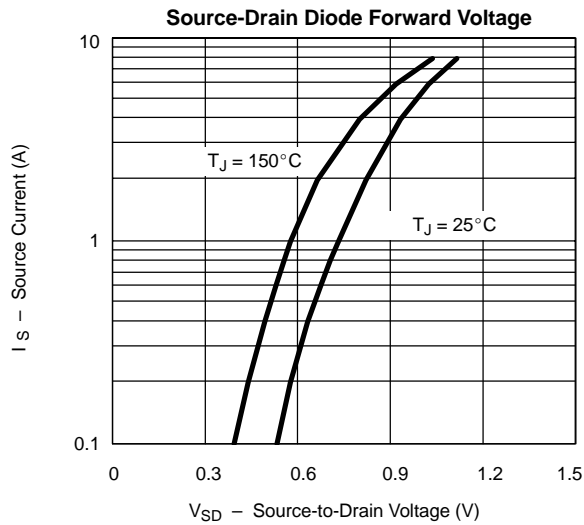



TYPICAL CHARACTERISTICS (25 °C UNLESS NOTED)

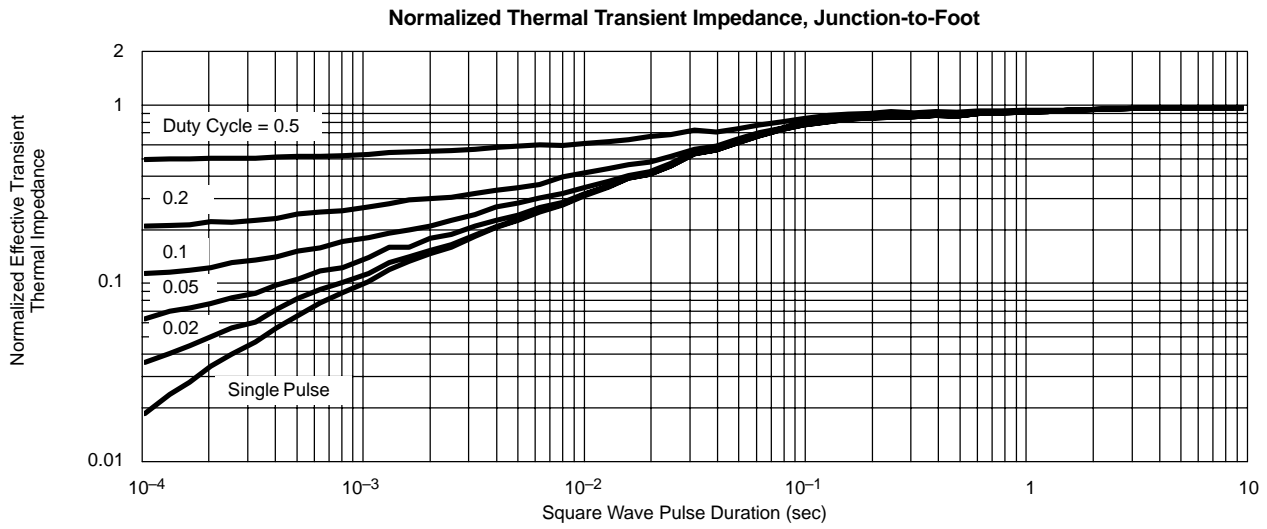



Notice

Specifications of the products displayed herein are subject to change without notice. Vishay Intertechnology, Inc., or anyone on its behalf, assumes no responsibility or liability for any errors or inaccuracies.

Information contained herein is intended to provide a product description only. No license, express or implied, by estoppel or otherwise, to any intellectual property rights is granted by this document. Except as provided in Vishay's terms and conditions of sale for such products, Vishay assumes no liability whatsoever, and disclaims any express or implied warranty, relating to sale and/or use of Vishay products including liability or warranties relating to fitness for a particular purpose, merchantability, or infringement of any patent, copyright, or other intellectual property right.

The products shown herein are not designed for use in medical, life-saving, or life-sustaining applications. Customers using or selling these products for use in such applications do so at their own risk and agree to fully indemnify Vishay for any damages resulting from such improper use or sale.