

# BTB12-600BW3G, BTB12-800BW3G

## Triacs Silicon Bidirectional Thyristors

Designed for high performance full-wave ac control applications where high noise immunity and high commutating di/dt are required.

### Features

- Blocking Voltage to 800 V
- On-State Current Rating of 12 Amperes RMS at 25°C
- Uniform Gate Trigger Currents in Three Quadrants
- High Immunity to dV/dt - 2000 V/μs minimum at 125°C
- Minimizes Snubber Networks for Protection
- Industry Standard TO-220AB Package
- High Commutating dI/dt - 4 A/ms minimum at 125°C
- These are Pb-Free Devices

### MAXIMUM RATINGS (T<sub>J</sub> = 25°C unless otherwise noted)

Rating	Symbol	Value	Unit
Peak Repetitive Off-State Voltage (Note 1) (T <sub>J</sub> = -40 to 125°C, Sine Wave, 50 to 60 Hz, Gate Open) BTB12-600BW3G BTB12-800BW3G	V <sub>DRM</sub> , V <sub>RRM</sub>	600 800	V
On-State RMS Current (Full Cycle Sine Wave, 60 Hz, T <sub>C</sub> = 80°C)	I <sub>T(RMS)</sub>	12	A
Peak Non-Repetitive Surge Current (One Full Cycle Sine Wave, 60 Hz, T <sub>C</sub> = 25°C)	I <sub>TSM</sub>	120	A
Circuit Fusing Consideration (t = 10 ms)	I <sup>2</sup> t	78	A <sup>2</sup> sec
Non-Repetitive Surge Peak Off-State Voltage (T <sub>J</sub> = 25°C, t = 10ms)	V <sub>DSM</sub> / V <sub>RSM</sub>	V <sub>DSM</sub> /V <sub>RSM</sub> +100	V
Peak Gate Current (T <sub>J</sub> = 125°C, t = 20ms)	I <sub>GM</sub>	4.0	A
Peak Gate Power (Pulse Width ≤ 1.0 μs, T <sub>C</sub> = 80°C)	P <sub>GM</sub>	20	W
Average Gate Power (T <sub>J</sub> = 125°C)	P <sub>G(AV)</sub>	1.0	W
Operating Junction Temperature Range	T <sub>J</sub>	-40 to +125	°C
Storage Temperature Range	T <sub>stg</sub>	-40 to +150	°C

Stresses exceeding Maximum Ratings may damage the device. Maximum Ratings are stress ratings only. Functional operation above the Recommended Operating Conditions is not implied. Extended exposure to stresses above the Recommended Operating Conditions may affect device reliability.

1. V<sub>DRM</sub> and V<sub>RRM</sub> for all types can be applied on a continuous basis. Blocking voltages shall not be tested with a constant current source such that the voltage ratings of the devices are exceeded.



ON Semiconductor®

<http://onsemi.com>

**TRIACS**  
**12 AMPERES RMS**  
**600 thru 800 VOLTS**

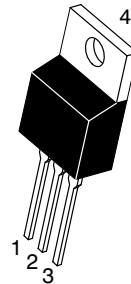
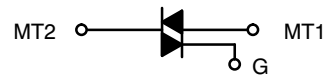

**TO-220AB**  
**CASE 221A**  
**STYLE 4**

- x = 6 or 8
- A = Assembly Location
- Y = Year
- WW = Work Week
- G = Pb-Free Package

### MARKING DIAGRAM

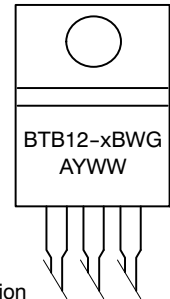

### PIN ASSIGNMENT

1	Main Terminal 1
2	Main Terminal 2
3	Gate
4	Main Terminal 2

### ORDERING INFORMATION

Device	Package	Shipping
BTB12-600BW3G	TO-220AB (Pb-Free)	50 Units / Rail
BTB12-800BW3G	TO-220AB (Pb-Free)	50 Units / Rail

\*For additional information on our Pb-Free strategy and soldering details, please download the ON Semiconductor Soldering and Mounting Techniques Reference Manual, SOLDERRM/D.

# BTB12-600BW3G, BTB12-800BW3G

## THERMAL CHARACTERISTICS

Characteristic	Symbol	Value	Unit
Thermal Resistance, Junction-to-Case	$R_{\theta JC}$	2.3	$^{\circ}\text{C}/\text{W}$
Junction-to-Ambient	$R_{\theta JA}$	60	
Maximum Lead Temperature for Soldering Purposes 1/8" from Case for 10 seconds	$T_L$	260	$^{\circ}\text{C}$

## ELECTRICAL CHARACTERISTICS ( $T_J = 25^{\circ}\text{C}$ unless otherwise noted; Electricals apply in both directions)

Characteristic	Symbol	Min	Typ	Max	Unit
<b>OFF CHARACTERISTICS</b>					
Peak Repetitive Blocking Current ( $V_D = \text{Rated } V_{DRM}, V_{RRM}, \text{ Gate Open}$ )	$I_{DRM}/I_{RRM}$	-	-	0.005	mA
		-	-	1.0	

## ON CHARACTERISTICS

Peak On-State Voltage (Note 2) ( $I_{TM} = \pm 17 \text{ A Peak}$ )	$V_{TM}$	-	-	1.55	V
Gate Trigger Current (Continuous dc) ( $V_D = 12 \text{ V}, R_L = 30 \Omega$ ) MT2(+), G(+) MT2(+), G(-) MT2(-), G(-)	$I_{GT}$	2.5 2.5 2.5	- - -	50 50 50	mA
Holding Current ( $V_D = 12 \text{ V}, \text{ Gate Open}, \text{ Initiating Current} = \pm 100 \text{ mA}$ )	$I_H$	-	-	50	mA
Latching Current ( $V_D = 24 \text{ V}, I_G = 60 \text{ mA}$ ) MT2(+), G(+) MT2(+), G(-) MT2(-), G(-)	$I_L$	- - -	- - -	70 90 70	mA
Gate Trigger Voltage ( $V_D = 12 \text{ V}, R_L = 30 \Omega$ ) MT2(+), G(+) MT2(+), G(-) MT2(-), G(-)	$V_{GT}$	0.5 0.5 0.5	- - -	1.7 1.1 1.1	V
Gate Non-Trigger Voltage ( $T_J = 125^{\circ}\text{C}$ ) MT2(+), G(+) MT2(+), G(-) MT2(-), G(-)	$V_{GD}$	0.2 0.2 0.2	- - -	- - -	V

## DYNAMIC CHARACTERISTICS

Rate of Change of Commutating Current, See Figure 10. (Gate Open, $T_J = 125^{\circ}\text{C}$ , No Snubber)	$(di/dt)_c$	4.0	-	-	A/ms
Critical Rate of Rise of On-State Current ( $T_J = 125^{\circ}\text{C}, f = 120 \text{ Hz}, I_G = 2 \times I_{GT}, tr \leq 100 \text{ ns}$ )	$di/dt$	-	-	50	A/ $\mu\text{s}$
Critical Rate of Rise of Off-State Voltage ( $V_D = 0.66 \times V_{DRM}, \text{ Exponential Waveform}, \text{ Gate Open}, T_J = 125^{\circ}\text{C}$ )	$dV/dt$	2000	-	-	V/ $\mu\text{s}$

2. Indicates Pulse Test: Pulse Width  $\leq 2.0 \text{ ms}$ , Duty Cycle  $\leq 2\%$ .

# BTB12-600BW3G, BTB12-800BW3G

## Voltage Current Characteristic of Triacs (Bidirectional Device)

Symbol	Parameter
$V_{DRM}$	Peak Repetitive Forward Off State Voltage
$I_{DRM}$	Peak Forward Blocking Current
$V_{RRM}$	Peak Repetitive Reverse Off State Voltage
$I_{RRM}$	Peak Reverse Blocking Current
$V_{TM}$	Maximum On State Voltage
$I_H$	Holding Current

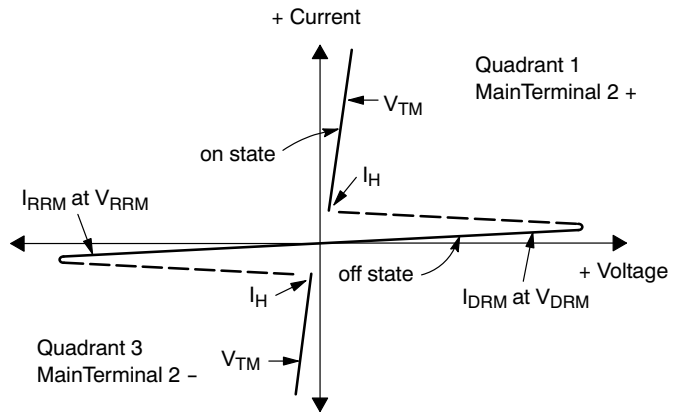

### Quadrant Definitions for a Triac

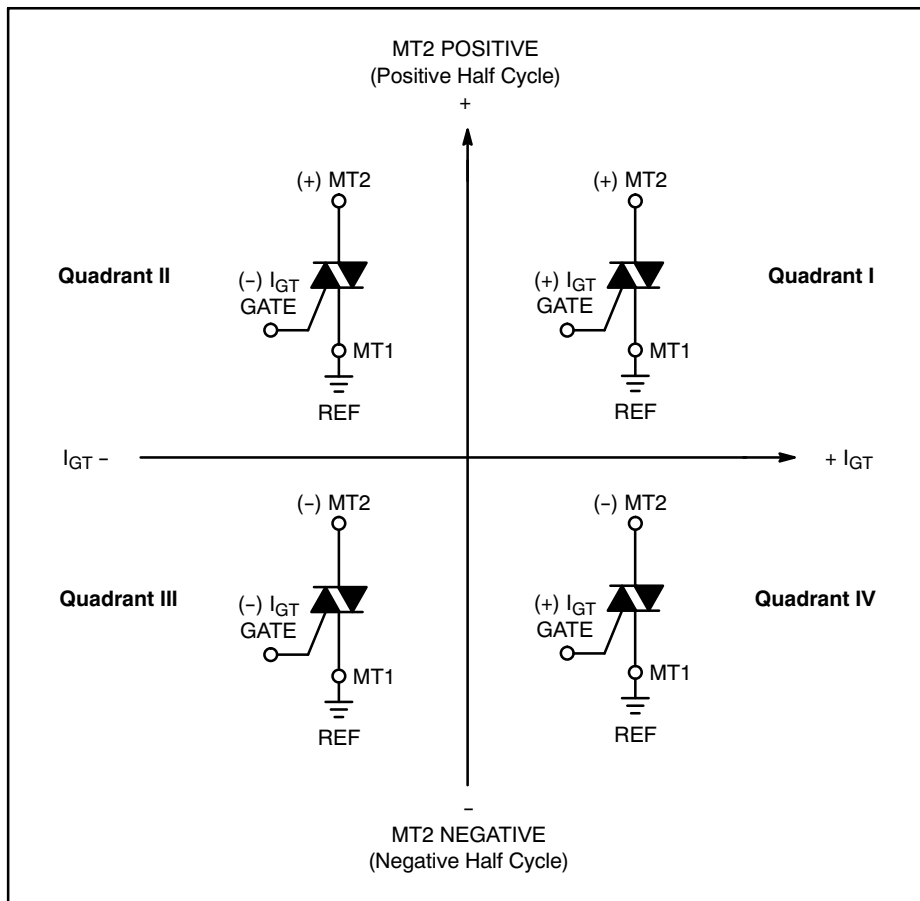

All polarities are referenced to MT1.  
With in-phase signals (using standard AC lines) quadrants I and III are used.

# BTB12-600BW3G, BTB12-800BW3G

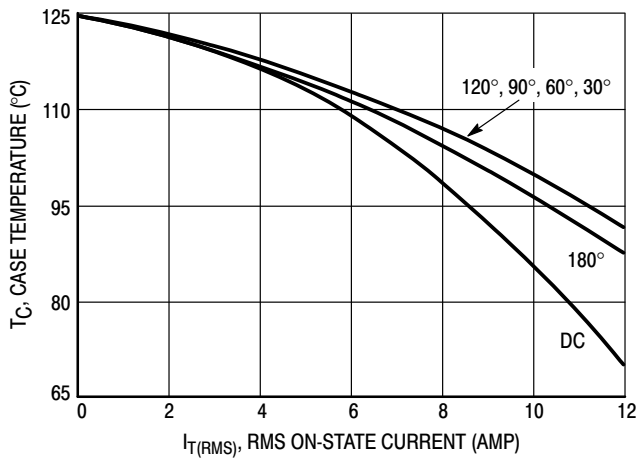

Figure 1. Typical RMS Current Derating

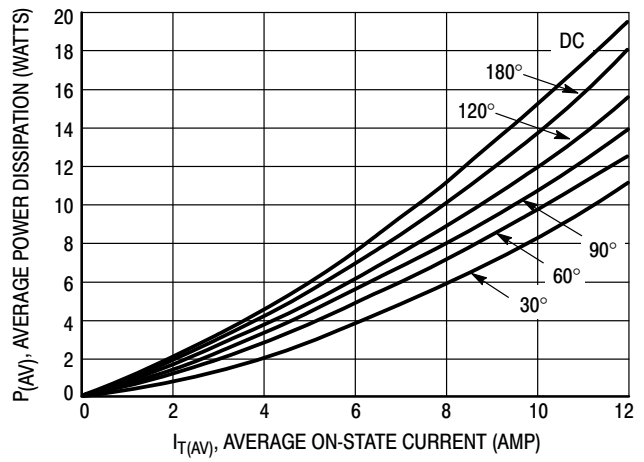

Figure 2. On-State Power Dissipation

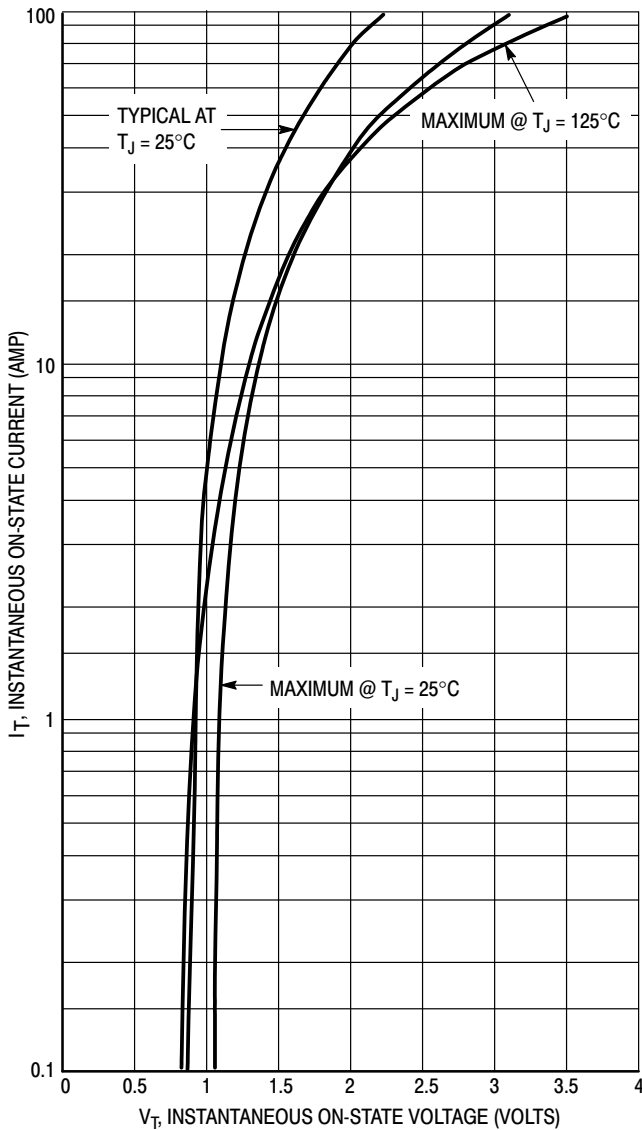

Figure 3. On-State Characteristics

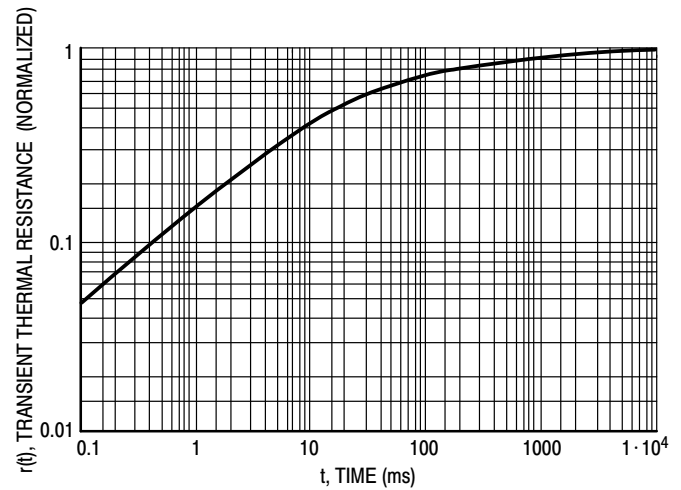

Figure 4. Thermal Response

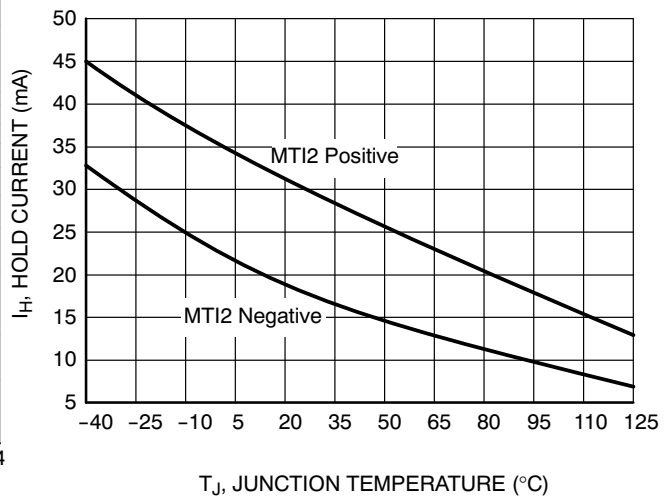

Figure 5. Typical Hold Current Variation

# BTB12-600BW3G, BTB12-800BW3G

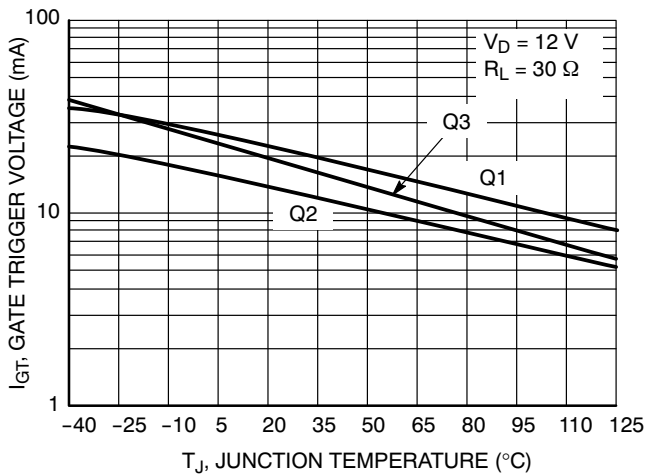

Figure 6. Typical Gate Trigger Current Variation

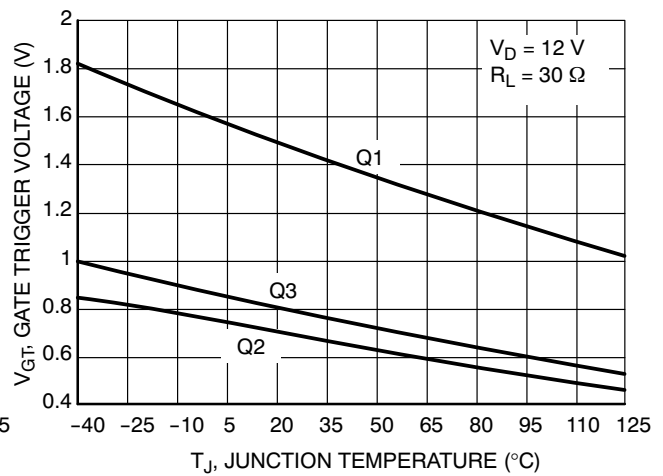

Figure 7. Typical Gate Trigger Voltage Variation

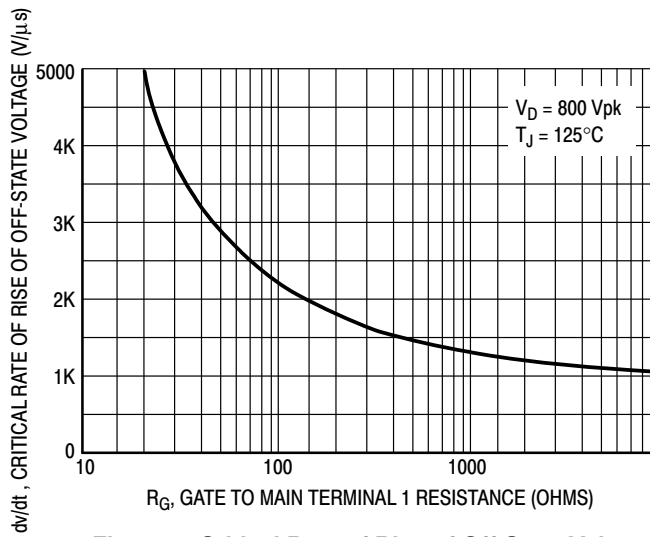
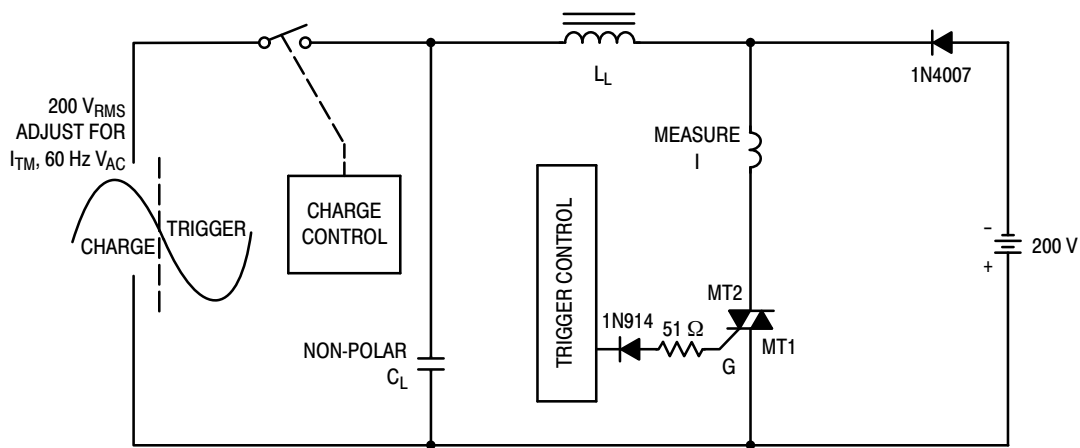

Figure 9. Critical Rate of Rise of Off-State Voltage (Exponential Waveform)



Note: Component values are for verification of rated  $(di/dt)_c$ . See AN1048 for additional information.

Figure 8. Simplified Test Circuit to Measure the Critical Rate of Rise of Commutating Current  $(di/dt)_c$

# BTB12-600BW3G, BTB12-800BW3G

## PACKAGE DIMENSIONS

TO-220  
CASE 221A-07  
ISSUE AA

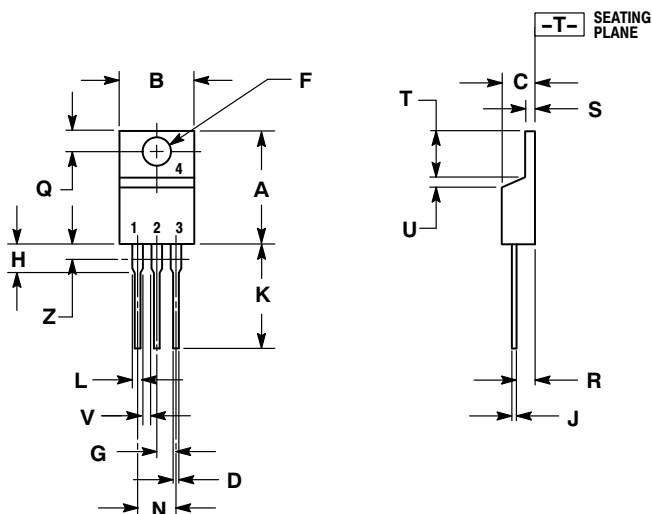

NOTES:

1. DIMENSIONING AND TOLERANCING PER ANSI Y14.5M, 1982.
2. CONTROLLING DIMENSION: INCH.
3. DIMENSION Z DEFINES A ZONE WHERE ALL BODY AND LEAD IRREGULARITIES ARE ALLOWED.

DIM	INCHES		MILLIMETERS	
	MIN	MAX	MIN	MAX
A	0.570	0.620	14.48	15.75
B	0.380	0.405	9.66	10.28
C	0.160	0.190	4.07	4.82
D	0.025	0.035	0.64	0.88
F	0.142	0.147	3.61	3.73
G	0.095	0.105	2.42	2.66
H	0.110	0.155	2.80	3.93
J	0.014	0.022	0.36	0.55
K	0.500	0.562	12.70	14.27
L	0.045	0.060	1.15	1.52
N	0.190	0.210	4.83	5.33
Q	0.100	0.120	2.54	3.04
R	0.080	0.110	2.04	2.79
S	0.045	0.055	1.15	1.39
T	0.235	0.255	5.97	6.47
U	0.000	0.050	0.00	1.27
V	0.045	---	1.15	---
Z	---	0.080	---	2.04

STYLE 4:

- PIN 1. MAIN TERMINAL 1
2. MAIN TERMINAL 2
3. GATE
4. MAIN TERMINAL 2

ON Semiconductor and are registered trademarks of Semiconductor Components Industries, LLC (SCILLC). SCILLC reserves the right to make changes without further notice to any products herein. SCILLC makes no warranty, representation or guarantee regarding the suitability of its products for any particular purpose, nor does SCILLC assume any liability arising out of the application or use of any product or circuit, and specifically disclaims any and all liability, including without limitation special, consequential or incidental damages. "Typical" parameters which may be provided in SCILLC data sheets and/or specifications can and do vary in different applications and actual performance may vary over time. All operating parameters, including "Typicals" must be validated for each customer application by customer's technical experts. SCILLC does not convey any license under its patent rights nor the rights of others. SCILLC products are not designed, intended, or authorized for use as components in systems intended for surgical implant into the body, or other applications intended to support or sustain life, or for any other application in which the failure of the SCILLC product could create a situation where personal injury or death may occur. Should Buyer purchase or use SCILLC products for any such unintended or unauthorized application, Buyer shall indemnify and hold SCILLC and its officers, employees, subsidiaries, affiliates, and distributors harmless against all claims, costs, damages, and expenses, and reasonable attorney fees arising out of, directly or indirectly, any claim of personal injury or death associated with such unintended or unauthorized use, even if such claim alleges that SCILLC was negligent regarding the design or manufacture of the part. SCILLC is an Equal Opportunity/Affirmative Action Employer. This literature is subject to all applicable copyright laws and is not for resale in any manner.

### PUBLICATION ORDERING INFORMATION

LITERATURE FULFILLMENT:

Literature Distribution Center for ON Semiconductor  
P.O. Box 5163, Denver, Colorado 80217 USA  
Phone: 303-675-2175 or 800-344-3860 Toll Free USA/Canada  
Fax: 303-675-2176 or 800-344-3867 Toll Free USA/Canada  
Email: orderlit@onsemi.com

N. American Technical Support: 800-282-9855 Toll Free  
USA/Canada  
Europe, Middle East and Africa Technical Support:  
Phone: 421 33 790 2910  
Japan Customer Focus Center  
Phone: 81-3-5773-3850

ON Semiconductor Website: [www.onsemi.com](http://www.onsemi.com)

Order Literature: <http://www.onsemi.com/orderlit>

For additional information, please contact your local Sales Representative

BTB12-600BW3/D