

\*RoHS COMPLIANT

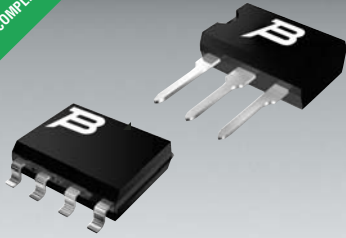

**BOURNS®**

**TISP7125F3 THRU TISP7180F3,  
TISP7240F3 THRU TISP7380F3**

**MEDIUM & HIGH-VOLTAGE TRIPLE ELEMENT  
BIDIRECTIONAL THYRISTOR OVERVOLTAGE PROTECTORS**

**TISP7xxxF3 (MV, HV) Overvoltage Protector Series**

**Patented Ion-Implanted Breakdown Region  
- Precise DC and Dynamic Voltages**

Device	V <sub>DRM</sub> V	V <sub>(BO)</sub> V
'7125F3	100	125
'7150F3	120	150
'7180F3	145	180
'7240F3	180	240
'7260F3	200	260
'7290F3	220	290
'7320F3	240	320
'7350F3	275	350
'7380F3†	270	380

† For new designs use '7350F3 instead of '7380F3

**Planar Passivated Junctions  
- Low Off-State Current.....<10 µA**

**Rated for International Surge Wave Shapes  
- Single and Simultaneous Impulses**

Waveshape	Standard	I <sub>TSP</sub> A
2/10	GR-1089-CORE	190
8/20	IEC 61000-4-5	175
10/160	FCC Part 68	110
10/700	FCC Part 68 ITU-T K.20/21	70
10/560	FCC Part 68	50
10/1000	GR-1089-CORE	45

**UL** ..... **UL Recognized Component**

**Description**

The TISP7xxxF3 series are 3-point overvoltage protectors designed for protecting against metallic (differential mode) and simultaneous longitudinal (common mode) surges. Each terminal pair has the same voltage limiting values and surge current capability. This terminal pair surge capability ensures that the protector can meet the simultaneous longitudinal surge requirement which is typically twice the metallic surge requirement.

**How To Order**

Device	Package	Carrier	Order As
TISP7xxxF3	D, Small-outline	Tape and Reel	TISP7xxxF3DR-S
		Tube	TISP7xxxF3D-S
TISP7xxxF3	SL, Single-in-line	Tube	TISP7xxxF3SL-S

**D Package (Top View)**

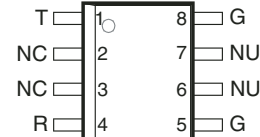

NC - No internal connection.

NU - Non-usable; no external electrical connection should be made to these pins.

Specified ratings require connection of pins 5 and 8.

**SL Package (Top View)**

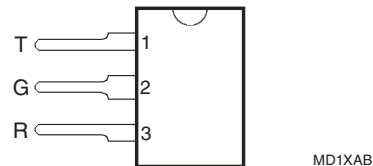

**Device Symbol**

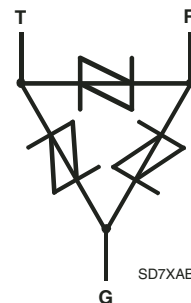

Terminals T, R and G correspond to the alternative line designators of A, B and C

\*RoHS Directive 2002/95/EC Jan 27 2003 including Annex MARCH 1994 - REVISED JANUARY 2007

Specifications are subject to change without notice. Customers should verify actual device performance in their specific applications.

# TISP7xxxF3 (MV, HV) Overvoltage Protector Series **BOURNS®**

## Description (continued)

Each terminal pair has a symmetrical voltage-triggered thyristor characteristic. Overvoltages are initially clipped by breakdown clamping until the voltage rises to the breakover level, which causes the device to crowbar into a low-voltage on state. This low-voltage on state causes the current resulting from the overvoltage to be safely diverted through the device. The high crowbar holding current prevents d.c. latchup as the diverted current subsides. These protectors are guaranteed to voltage limit and withstand the listed lightning surges in both polarities.

These medium and high voltage devices are offered in nine voltage variants to meet a range of battery and ringing voltage requirements. They are guaranteed to suppress and withstand the listed international lightning surges on any terminal pair. Similar devices with working voltages of 58 V and 66 V are detailed in the TISP7072F3, TISP7082F3 data sheet.

## Absolute Maximum Ratings, $T_A = 25\text{ }^\circ\text{C}$ (Unless Otherwise Noted)

Rating	Symbol	Value	Unit
Repetitive peak off-state voltage, $0\text{ }^\circ\text{C} < T_A < 70\text{ }^\circ\text{C}$			
'7125F3	$V_{\text{DRM}}$	100	V
'7150F3		120	
'7180F3		145	
'7240F3		180	
'7260F3		200	
'7290F3		220	
'7320F3		240	
'7350F3		275	
'7380F3		270	
Non-repetitive peak on-state pulse current (see Notes 1 and 2)			
1/2 (Gas tube differential transient, 1/2 voltage wave shape)	$I_{\text{PPSM}}$	330	A
2/10 (Telcordia GR-1089-CORE, 2/10 voltage wave shape)		190	
1/20 (ITU-T K.22, 1.2/50 voltage wave shape, 25 $\Omega$ resistor)		100	
8/20 (IEC 61000-4-5, combination wave generator, 1.2/50 voltage wave shape)		175	
10/160 (FCC Part 68, 10/160 voltage wave shape)		110	
4/250 (ITU-T K.20/21, 10/700 voltage wave shape, simultaneous)		95	
0.2/310 (CNET I 31-24, 0.5/700 voltage wave shape)		70	
5/310 (ITU-T K.20/21, 10/700 voltage wave shape, single)		70	
5/320 (FCC Part 68, 9/720 voltage wave shape, single)		70	
10/560 (FCC Part 68, 10/560 voltage wave shape)		50	
10/1000 (Telcordia GR-1089-CORE, 10/1000 voltage wave shape)		45	
Non-repetitive peak on-state current, $0\text{ }^\circ\text{C} < T_A < 70\text{ }^\circ\text{C}$ (see Notes 1 and 3) 50 Hz, 1 s			
D Package	$I_{\text{TSM}}$	4.3	A
SL Package		7.1	
Initial rate of rise of on-state current, Linear current ramp, Maximum ramp value $< 38\text{ A}$	$di_T/dt$	250	A/ $\mu\text{s}$
Junction temperature	$T_J$	-65 to +150	$^\circ\text{C}$
Storage temperature range	$T_{\text{stg}}$	-65 to +150	$^\circ\text{C}$

- NOTES: 1. Initially, the TISP® device must be in thermal equilibrium at the specified  $T_A$ . The impulse may be repeated after the TISP® device returns to its initial conditions. The rated current values may be applied either to the R to G or to the T to G or to the T to R terminals. Additionally, both R to G and T to G may have their rated current values applied simultaneously (In this case the total G terminal current will be twice the above rated current values).
2. See Thermal Information for derated  $I_{\text{PPSM}}$  values  $0\text{ }^\circ\text{C} < T_A < 70\text{ }^\circ\text{C}$  and Applications Information for details on wave shapes.
3. Above  $70\text{ }^\circ\text{C}$ , derate  $I_{\text{TSM}}$  linearly to zero at  $150\text{ }^\circ\text{C}$  lead temperature.

MARCH 1994 - REVISED JANUARY 2007

Specifications are subject to change without notice.

Customers should verify actual device performance in their specific applications.

# TISP7xxxF3 (MV, HV) Overvoltage Protector Series **BOURNS**®

## Electrical Characteristics for all Terminal Pairs, T<sub>A</sub> = 25 °C (Unless Otherwise Noted)

Parameter	Test Conditions	Min	Typ	Max	Unit
I <sub>DRM</sub> Repetitive peak off-state current	V <sub>D</sub> = V <sub>DRM</sub> , 0 °C < T <sub>A</sub> < 70 °C			±10	μA
V <sub>(BO)</sub> Breakover voltage	dv/dt = ±250 V/ms, R <sub>SOURCE</sub> = 300 Ω			±125 ±150 ±180 ±240 ±260 ±290 ±320 ±350 ±380	V
V <sub>(BO)</sub> Impulse breakover voltage	dv/dt ≤ ±1000 V/μs, Linear voltage ramp, Maximum ramp value = ±500 V di/dt = ±20 A/μs, Linear current ramp, Maximum ramp value = ±10 A			±143 ±168 ±198 ±269 ±289 ±319 ±349 ±379 ±409	V
I <sub>(BO)</sub> Breakover current	dv/dt = ±250 V/ms, R <sub>SOURCE</sub> = 300 Ω	±0.1		±0.8	A
V <sub>T</sub> On-state voltage	I <sub>T</sub> = ±5 A, t <sub>W</sub> = 100 μs			±5	V
I <sub>H</sub> Holding current	I <sub>T</sub> = ±5 A, di/dt = -/+30 mA/ms	±0.15			A
dv/dt Critical rate of rise of off-state voltage	Linear voltage ramp, Maximum ramp value < 0.85V <sub>DRM</sub>	±5			kV/μs
I <sub>D</sub> Off-state current	V <sub>D</sub> = ±50 V			±10	μA
C <sub>off</sub> Off-state capacitance	f = 1 MHz, V <sub>d</sub> = 1 V rms, V <sub>D</sub> = 0	'7125 thru '7180 '7240 thru '7380	37 31	48 41	pF
	f = 1 MHz, V <sub>d</sub> = 1 V rms, V <sub>D</sub> = -1 V	'7125 thru '7180 '7240 thru '7380	40 34	52 44	
	f = 1 MHz, V <sub>d</sub> = 1 V rms, V <sub>D</sub> = -2 V	'7125 thru '7180 '7240 thru '7380	36 30	47 39	
	f = 1 MHz, V <sub>d</sub> = 1 V rms, V <sub>D</sub> = -5 V	'7125 thru '7180 '7240 thru '7380	31 24	40 31	
	f = 1 MHz, V <sub>d</sub> = 1 V rms, V <sub>D</sub> = -50 V	'7125 thru '7180 '7240 thru '7380	17 13	23 17	
	f = 1 MHz, V <sub>d</sub> = 1 V rms, V <sub>D</sub> = -100 V	'7125 thru '7180 '7240 thru '7380	14 10	18 13	
	f = 1 MHz, V <sub>d</sub> = 1 V rms, V <sub>DTR</sub> = 0 (see Note 4)	'7125 thru '7180 '7240 thru '7380	20 17	27 23	

NOTE 4: Three-terminal guarded measurement, unmeasured terminal voltage bias is zero. First six capacitance values, with bias V<sub>D</sub>, are for the R-G and T-G terminals only. The last capacitance value, with bias V<sub>DTR</sub>, is for the T-R terminals.

## Thermal Characteristics

Parameter	Test Conditions	Min	Typ	Max	Unit
R <sub>θJA</sub> Junction to free air thermal resistance	P <sub>tot</sub> = 0.8 W, T <sub>A</sub> = 25 °C 5 cm <sup>2</sup> , FR4 PCB	D Package		160	°C/W
		SL Package		135	

MARCH 1994 - REVISED JANUARY 2007

Specifications are subject to change without notice.  
Customers should verify actual device performance in their specific applications.

Parameter Measurement Information

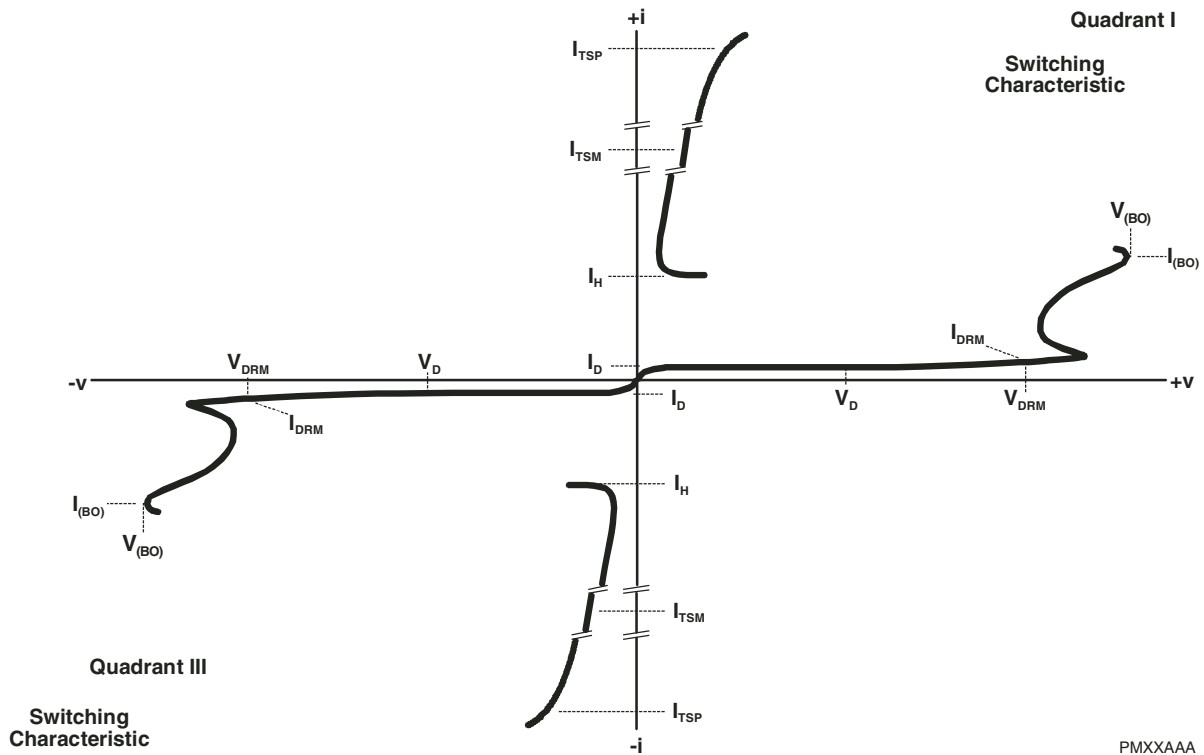

PMXXAAA

**Figure 1. Voltage-Current Characteristic for T and R Terminals**  
 T and G and R and G Measurements are Referenced to the G Terminal  
 T and R Measurements are Referenced to the R Terminal

# TISP7xxxF3 (MV, HV) Overvoltage Protector Series **BOURNS**<sup>®</sup>

Typical Characteristics - R and G, or T and G Terminals

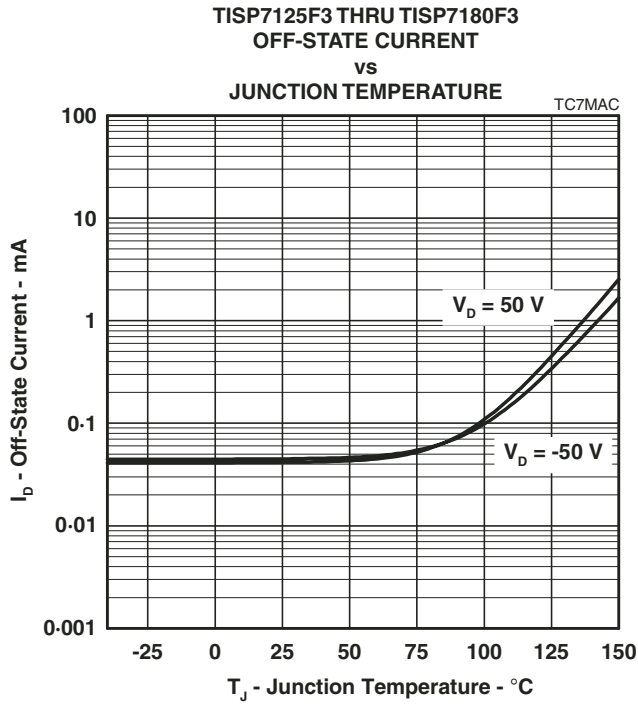

Figure 2.

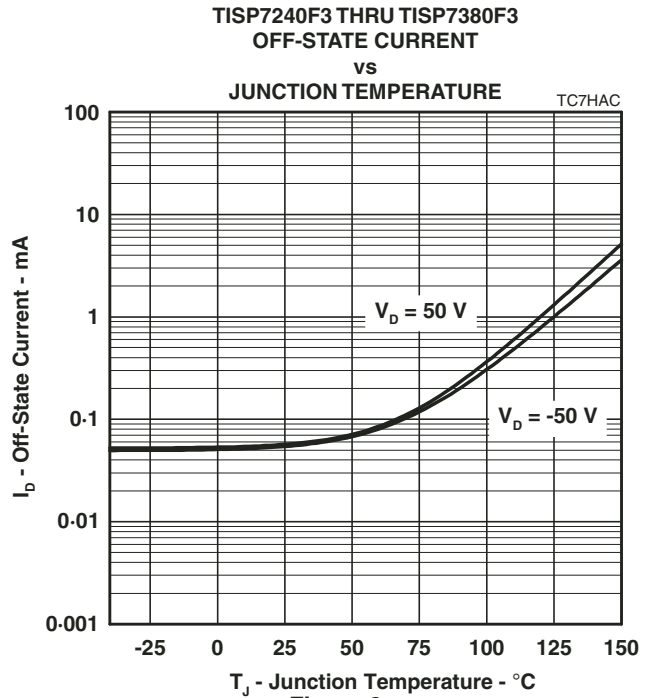

Figure 3.

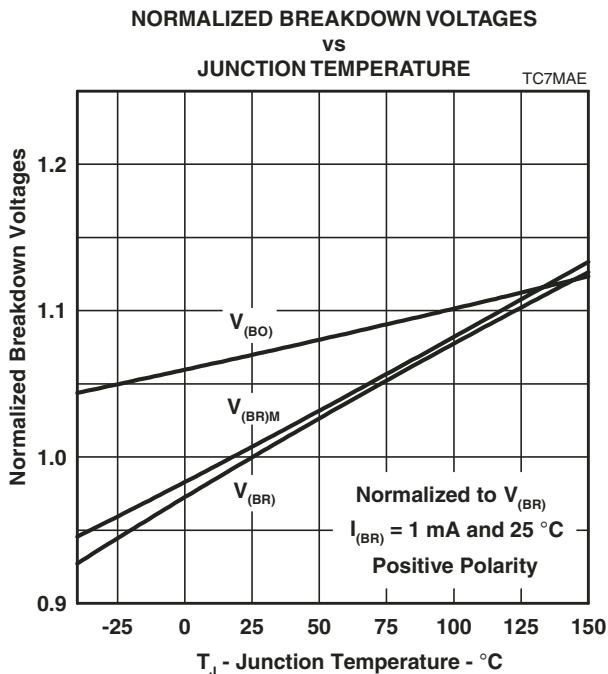

Figure 4.

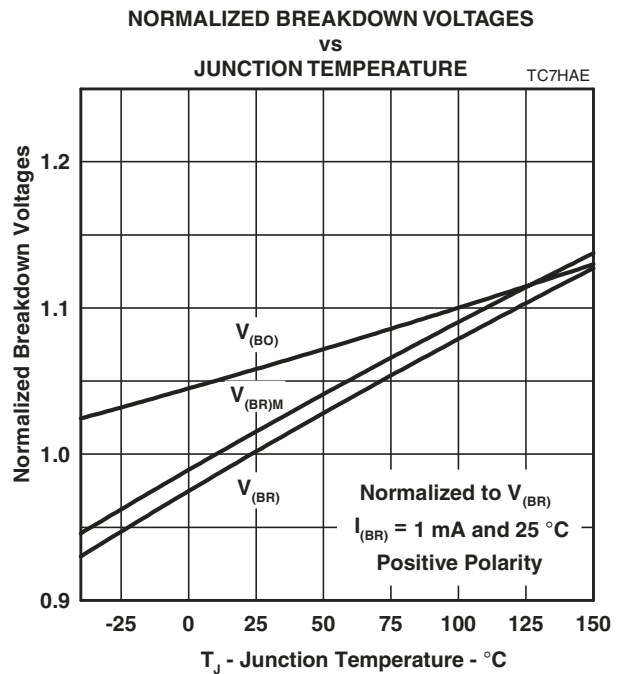
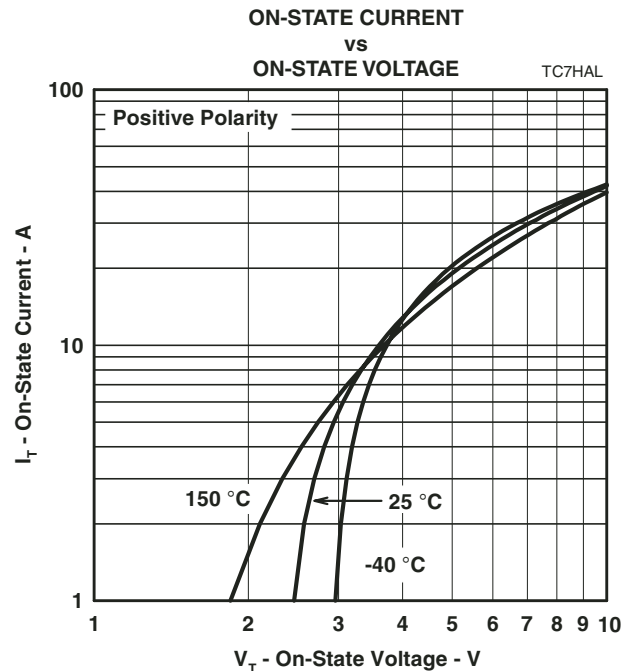
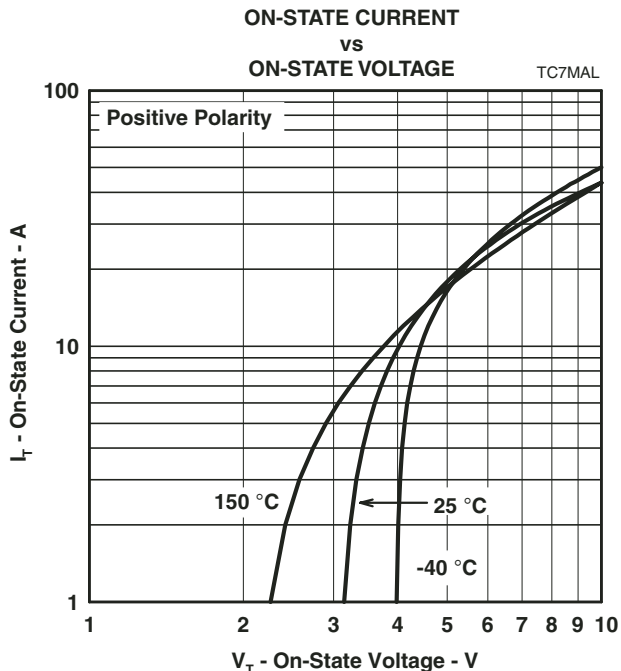
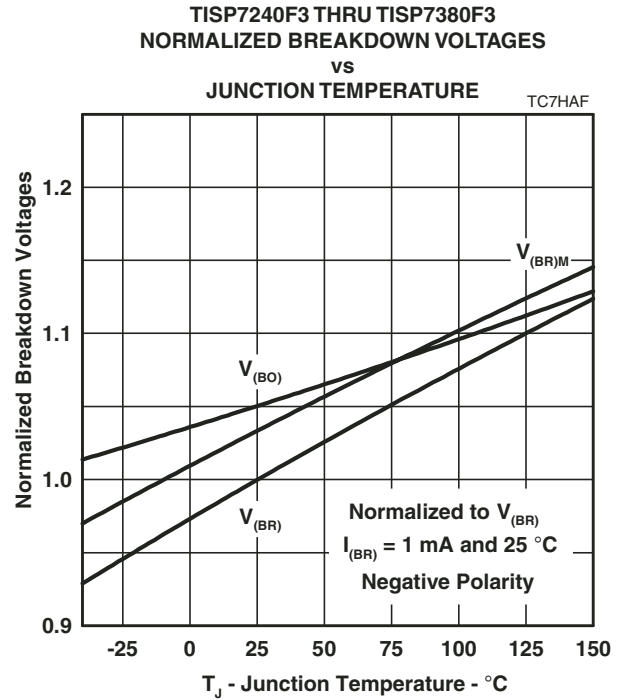
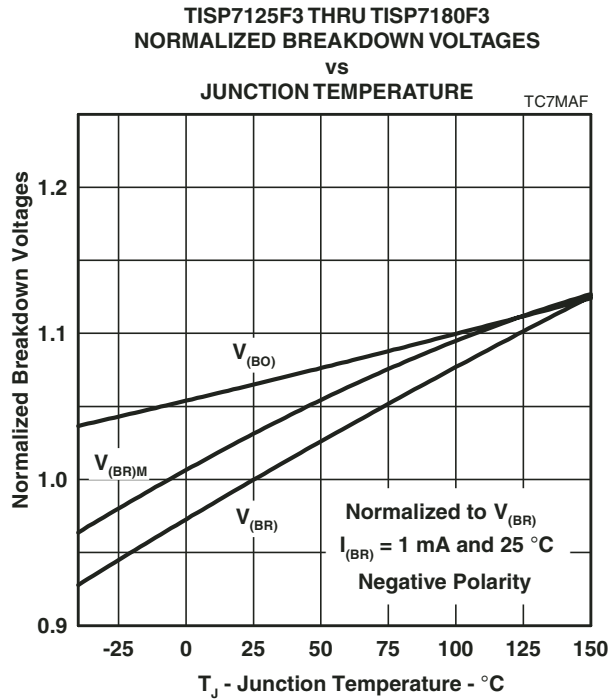

Figure 5.

MARCH 1994 - REVISED JANUARY 2007  
Specifications are subject to change without notice.  
Customers should verify actual device performance in their specific applications.

# TISP7xxxF3 (MV, HV) Overvoltage Protector Series **BOURNS®**

Typical Characteristics - R and G, or T and G Terminals



MARCH 1994 - REVISED JANUARY 2007  
Specifications are subject to change without notice.  
Customers should verify actual device performance in their specific applications.

# TISP7xxxF3 (MV, HV) Overvoltage Protector Series **BOURNS®**

Typical Characteristics - R and G, or T and G Terminals

TISP7125F3 THRU TISP7180F3  
ON-STATE CURRENT  
vs  
ON-STATE VOLTAGE

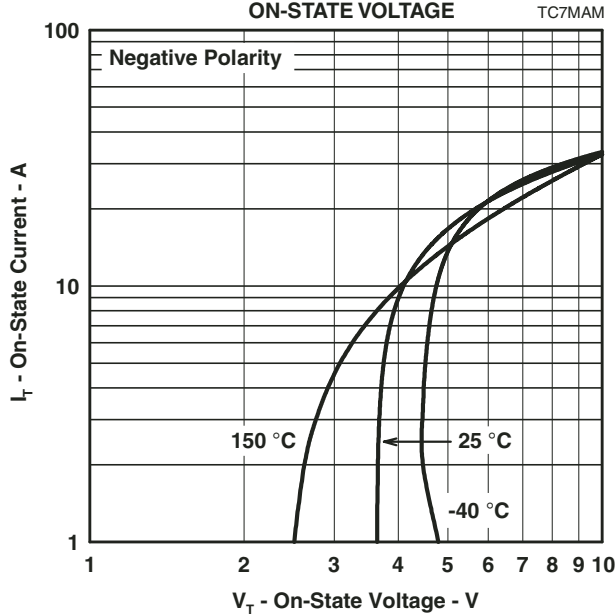

Figure 10.

TISP7240F3 THRU TISP7380F3  
ON-STATE CURRENT  
vs  
ON-STATE VOLTAGE

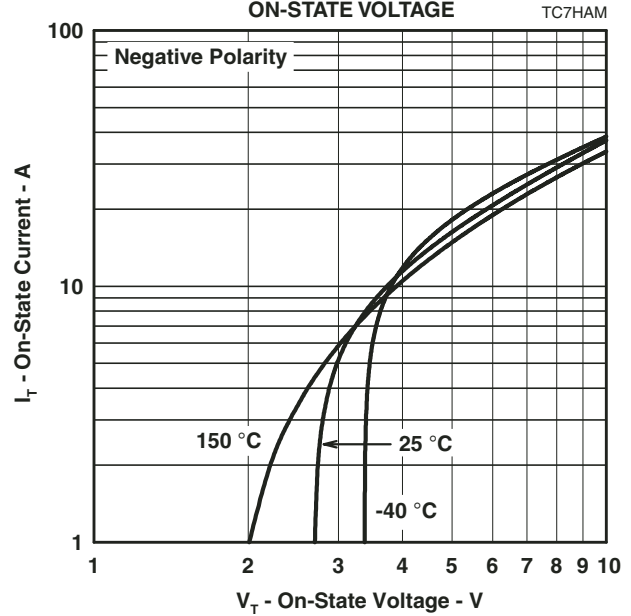

Figure 11.

HOLDING CURRENT & BREAKOVER CURRENT

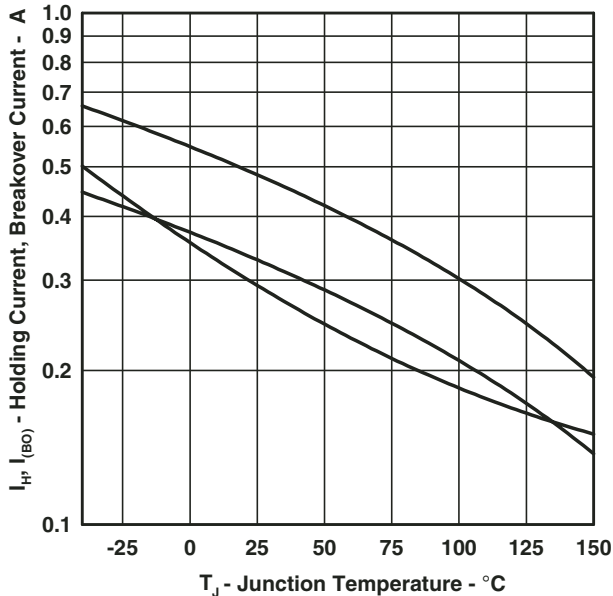

Figure 12.

HOLDING CURRENT & BREAKOVER CURRENT  
vs  
JUNCTION TEMPERATURE

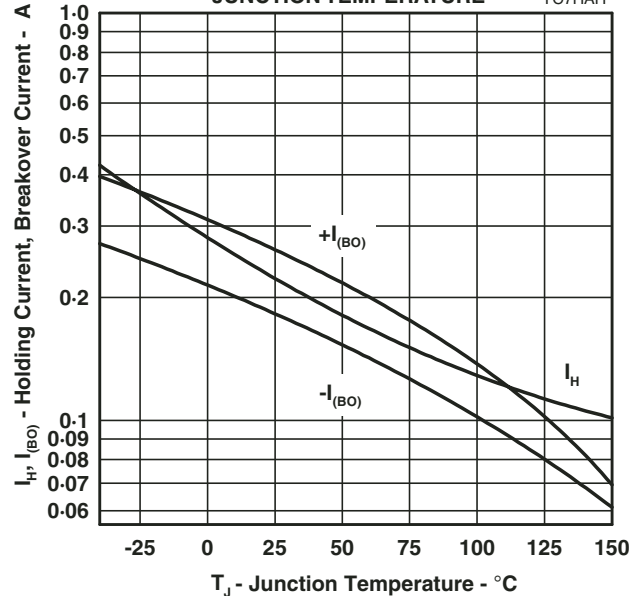

Figure 13.

MARCH 1994 - REVISED JANUARY 2007

Specifications are subject to change without notice.  
Customers should verify actual device performance in their specific applications.

## Typical Characteristics - R and G, or T and G Terminals

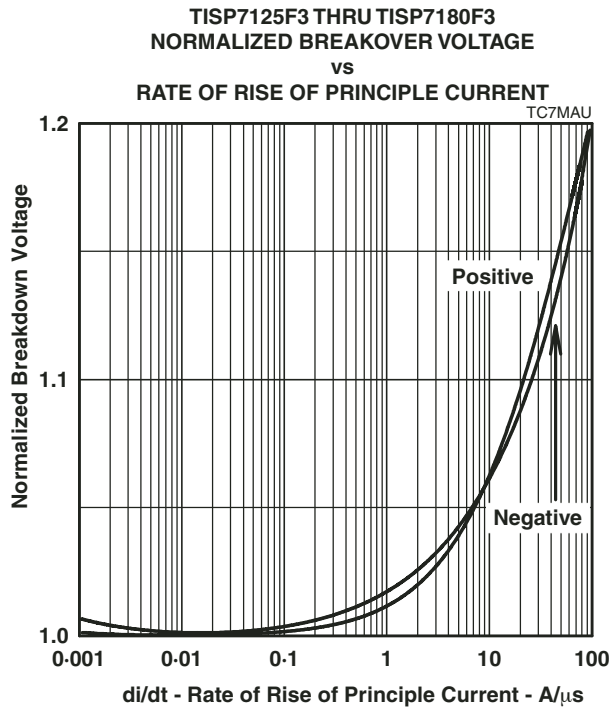

Figure 14.

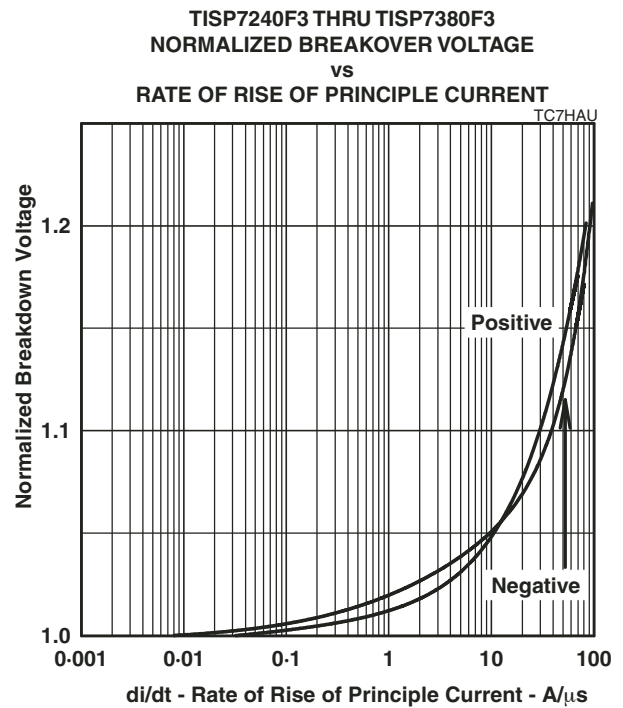

Figure 15.

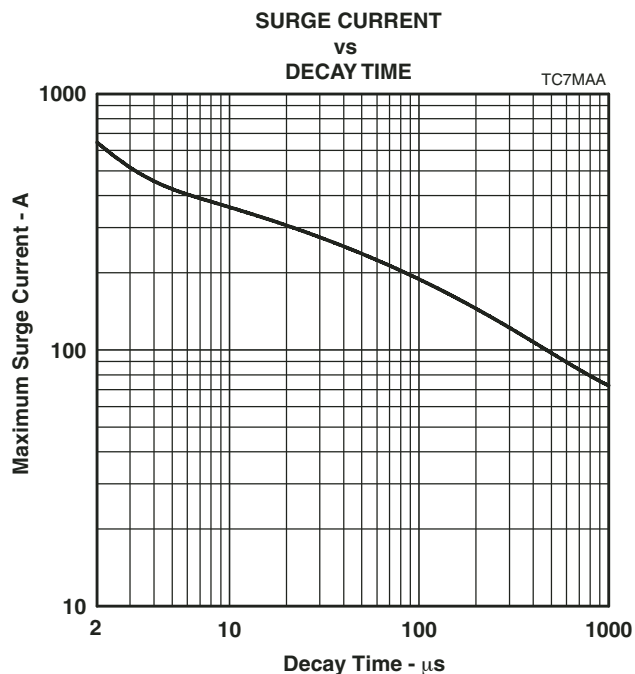

Figure 16.

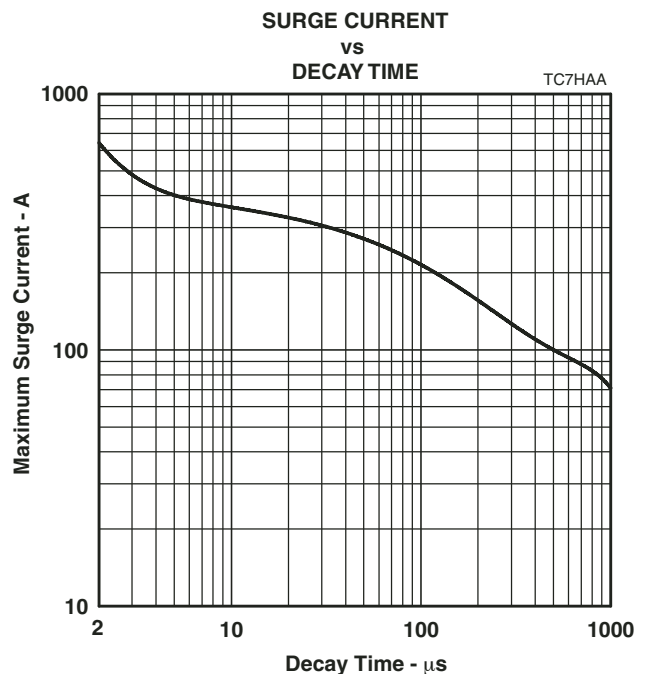

Figure 17.

MARCH 1994 - REVISED JANUARY 2007  
Specifications are subject to change without notice.  
Customers should verify actual device performance in their specific applications.



# TISP7xxxF3 (MV, HV) Overvoltage Protector Series **BOURNS**<sup>®</sup>

## Typical Characteristics - R and T Terminals

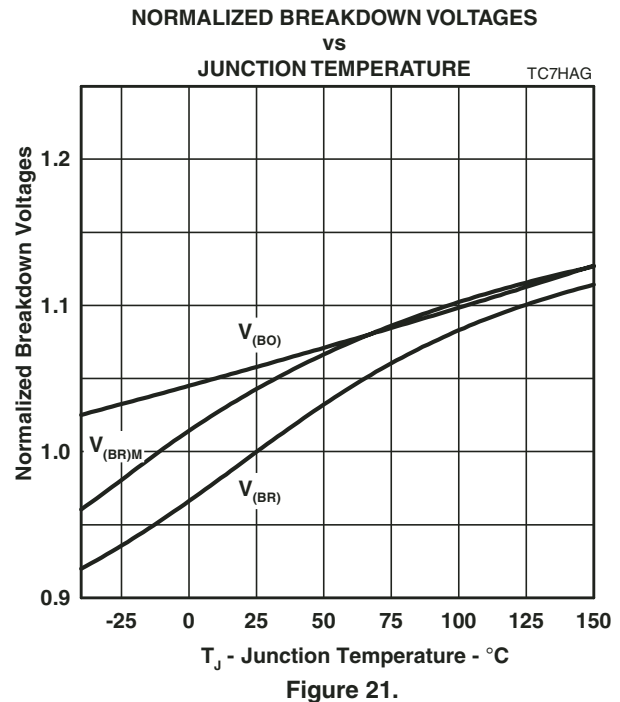
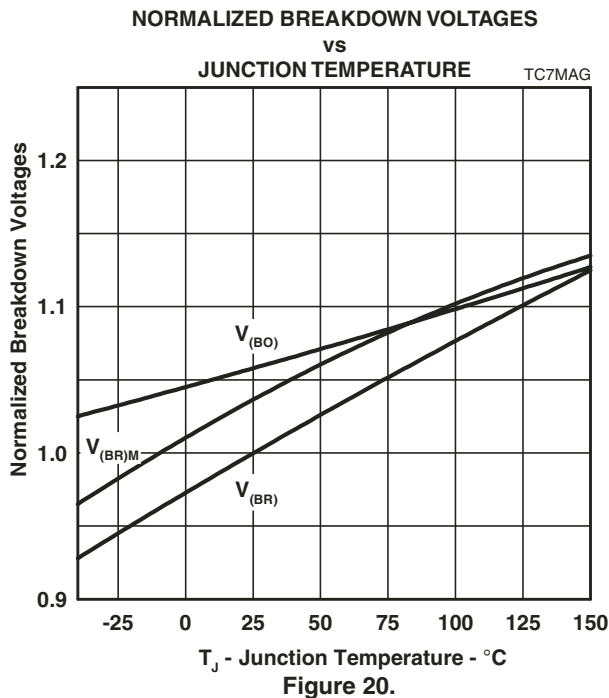
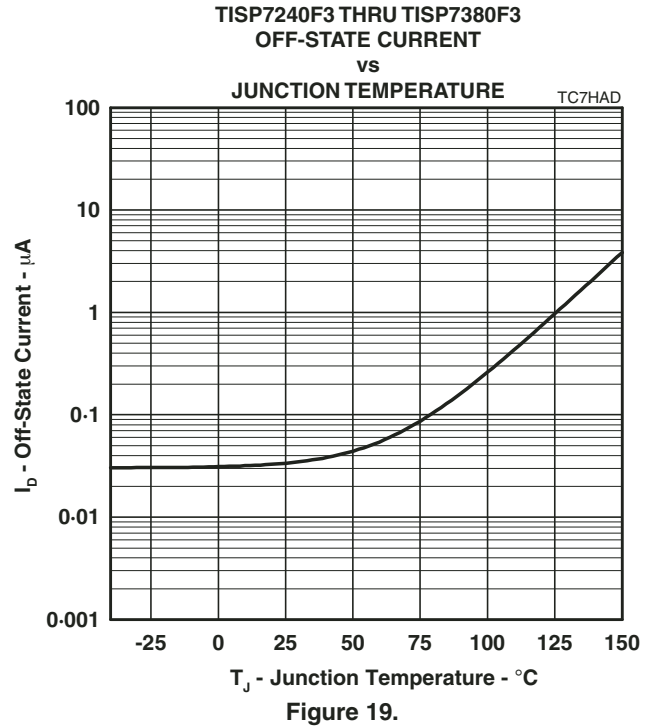
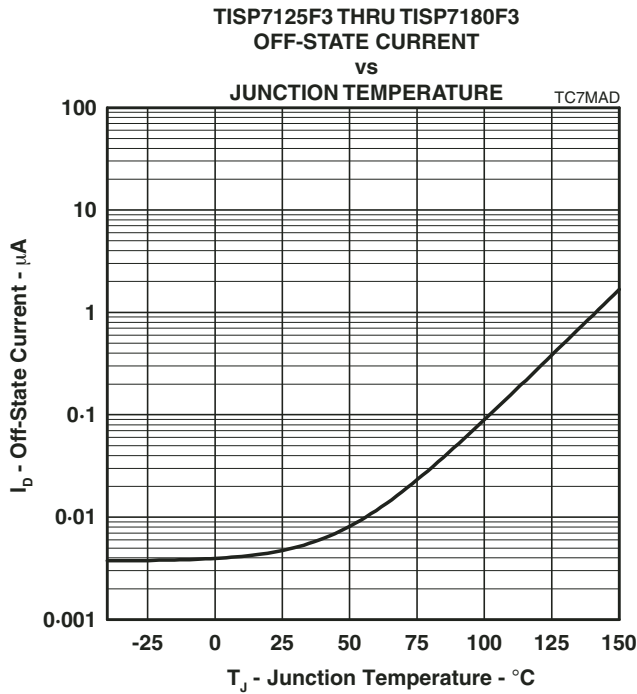

MARCH 1994 - REVISED JANUARY 2007  
Specifications are subject to change without notice.  
Customers should verify actual device performance in their specific applications.

## Typical Characteristics - R and T Terminals

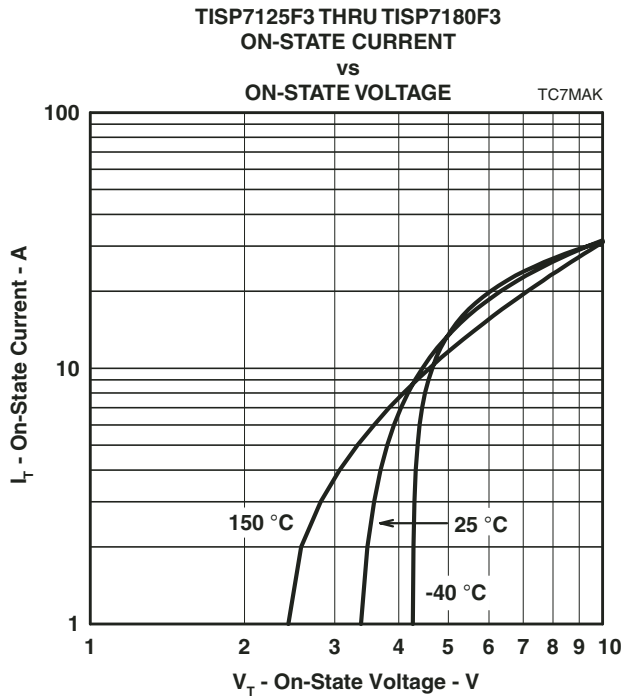

Figure 22.

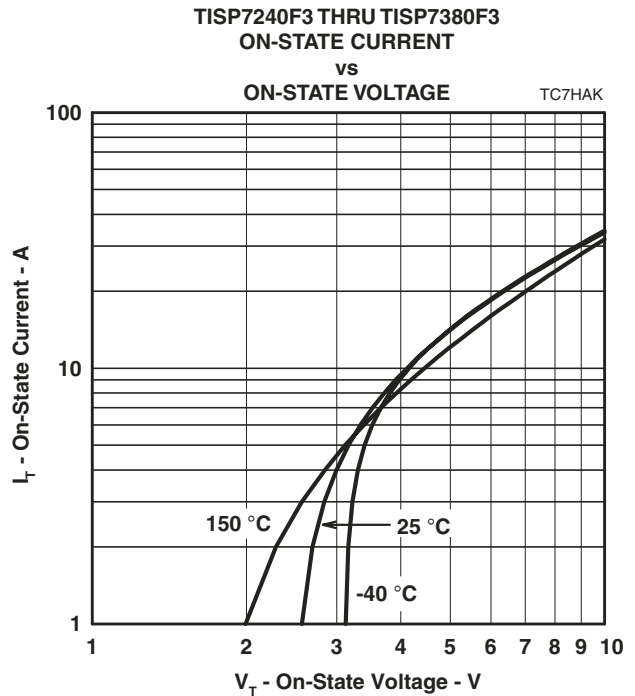

Figure 23.

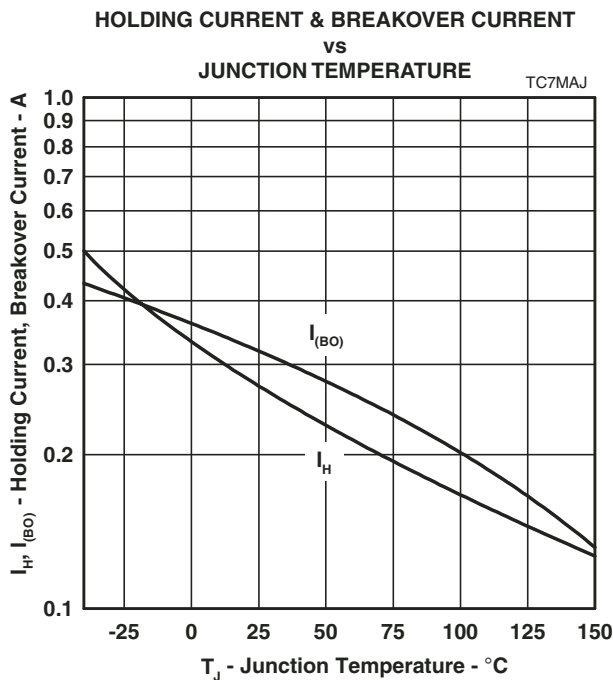

Figure 24.

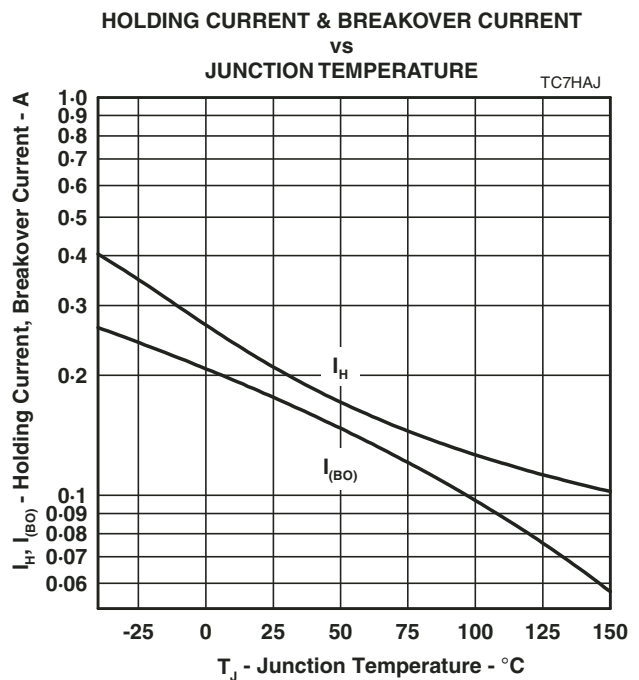

Figure 25.

MARCH 1994 - REVISED JANUARY 2007

Specifications are subject to change without notice.

Customers should verify actual device performance in their specific applications.

# TISP7xxxF3 (MV, HV) Overvoltage Protector Series **BOURNS®**

## Typical Characteristics - R and T Terminals

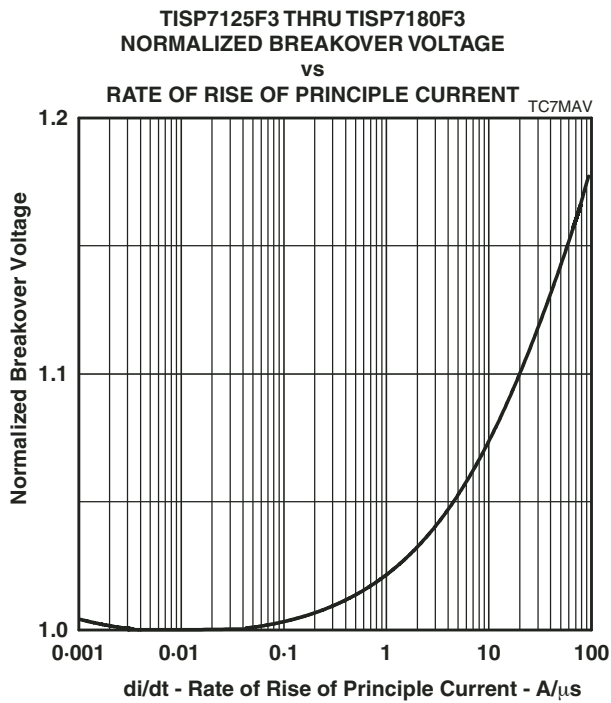

Figure 26.

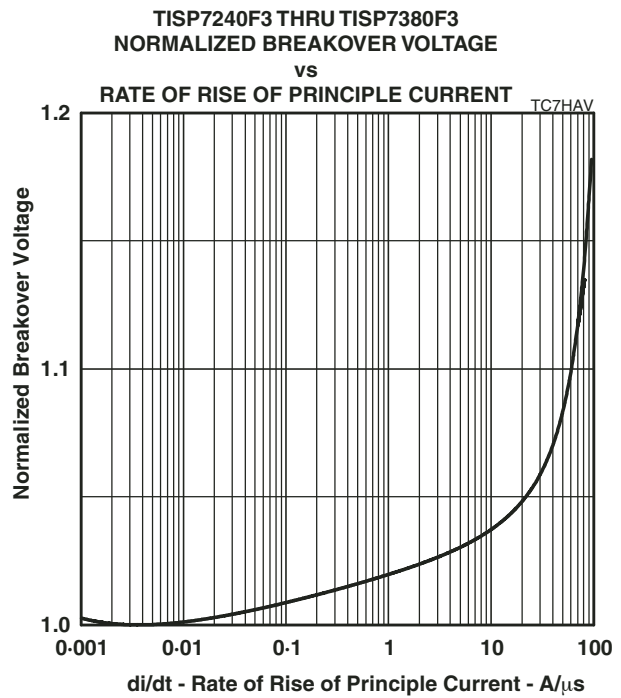
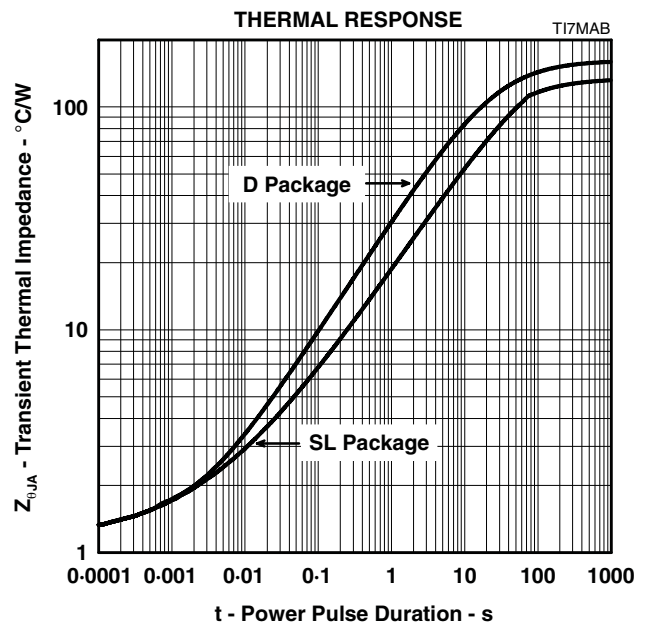
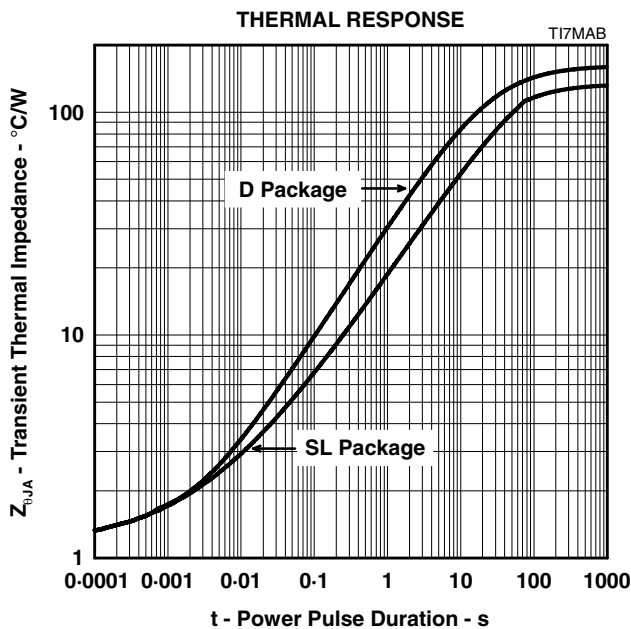
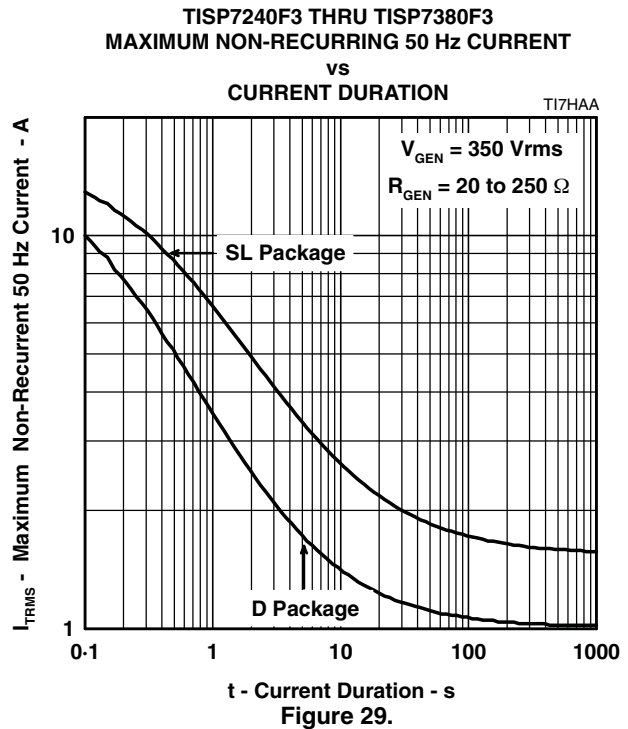
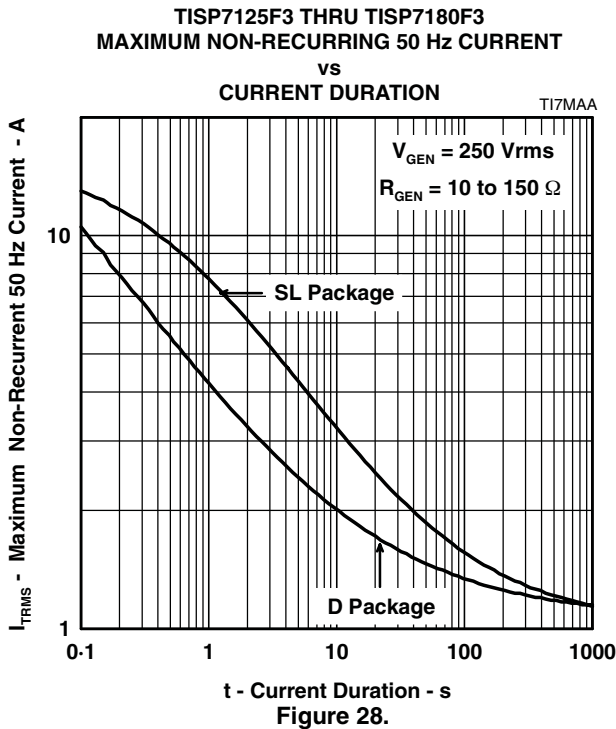

Figure 27.

## Thermal Information



MARCH 1994 - REVISED JANUARY 2007  
 Specifications are subject to change without notice.  
 Customers should verify actual device performance in their specific applications.

# TISP7xxxF3 (MV, HV) Overvoltage Protector Series **BOURNS®**

## Thermal Information

Rating	Symbol	Value	Unit
Non-repetitive peak on-state pulse current, $0\text{ }^{\circ}\text{C} < T_A < 70\text{ }^{\circ}\text{C}$ (see Notes 5, 6 and 7)			
1/2 (Gas tube differential transient, 1/2 voltage wave shape)		320	
2/10 (Telcordia GR-1089-CORE, 2/10 voltage wave shape)		175	
1/20 (ITU-T K.22, 1.2/50 voltage wave shape, 25 $\Omega$ resistor)		90	
8/20 (IEC 61000-4-5, combination wave generator, 1.2/50 voltage wave shape)		150	
10/160 (FCC Part 68, 10/160 voltage wave shape)		90	
4/250 (ITU-T K.20/21, 10/700 voltage wave shape, dual)	$I_{PPSM}$	70	A
0.2/310 (CNET I 31-24, 0.5/700 voltage wave shape)		65	
5/310 (ITU-T K.20/21, 10/700 voltage wave shape, single)		65	
5/320 (FCC Part 68, 9/720 voltage wave shape)		65	
10/560 (FCC Part 68, 10/560 voltage wave shape)		45	
10/1000 (Telcordia GR-1089-CORE, 10/1000 voltage wave shape)		40	

- NOTES: 5. Initially, the TISP® device must be in thermal equilibrium at the specified  $T_A$ . The impulse may be repeated after the TISP® device returns to its initial conditions. The rated current values may be applied either to the R to G or to the T to G or to the T to R terminals. Additionally, both R to G and T to G may have their rated current values applied simultaneously (In this case the total G terminal current will be twice the above rated current values).
6. See Applications Information for details on wave shapes.
7. Above 70 °C, derate  $I_{PPSM}$  linearly to zero at 150 °C lead temperature.

## APPLICATIONS INFORMATION

**Deployment**

These devices are three terminal overvoltage protectors. They limit the voltage between three points in the circuit. Typically, this would be the two line conductors and protective ground (Figure 32).

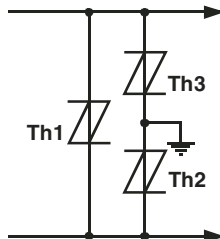

**Figure 32. MULTI-POINT PROTECTION**

In Figure 32, protective functions Th2 and Th3 limit the maximum voltage between each conductor and ground to their respective  $\pm V_{(BO)}$  values. Protective function Th1 limits the maximum voltage between the two conductors to its  $\pm V_{(BO)}$  value.

**Lightning Surge****Wave Shape Notation**

Most lightning tests, used for equipment verification, specify a unidirectional sawtooth waveform which has an exponential rise and an exponential decay. Wave shapes are classified in terms of rise time in microseconds and a decay time in microseconds to 50 % of the maximum amplitude. The notation used for the wave shape is *rise time/decay time*, without the microseconds quantity and the “/” between the two values has no mathematical significance. A 50 A, 5/310 waveform would have a peak current value of 50 A, a rise time of 5  $\mu$ s and a decay time of 310  $\mu$ s. The TISP® surge current graph comprehends the wave shapes of commonly used surges.

**Generators**

There are three categories of surge generator type: single wave shape, combination wave shape and circuit defined. Single wave shape generators have essentially the same wave shape for the open circuit voltage and short circuit current (e.g. 10/1000 open circuit voltage and short circuit current). Combination generators have two wave shapes, one for the open circuit voltage and the other for the short circuit current (e.g. 1.2/50 open circuit voltage and 8/20 short circuit current). Circuit specified generators usually equate to a combination generator, although typically only the open circuit voltage wave shape is referenced (e.g. a 10/700 open circuit voltage generator typically produces a 5/310 short circuit current). If the combination or circuit defined generators operate into a finite resistance, the wave shape produced is intermediate between the open circuit and short circuit values.

**ITU-T 10/700 Generator**

This circuit defined generator is specified in many standards. The descriptions and values are not consistent between standards and it is important to realize that it is always the same generator being used.

Figure 33 shows the 10/700 generator circuit defined in ITU-T recommendation K.20 (10/96) “Resistibility of telecommunication switching equipment to overvoltages and overcurrents”. The basic generator comprises of:

- Capacitor  $C_1$ , charged to voltage  $V_C$ , which is the energy storage element
- Switch SW to discharge the capacitor into the output shaping network
- Shunt resistor  $R_1$ , series resistor  $R_2$  and shunt capacitor  $C_2$  form the output shaping network
- Series feed resistor  $R_3$  to connect to one line conductor for single surge
- Series feed resistor  $R_4$  to connect to the other line conductor for dual surging

In the normal single surge equipment test configuration, the unsurged line is grounded. This is shown by the dotted lines in the top drawing of Figure 33. However, doing this at device test places one terminal pair in parallel with another terminal pair. To check the individual terminal pairs of the TISP7xxxF3, without any paralleled operation, the unsurged terminal is left unconnected.

# TISP7xxxF3 (MV, HV) Overvoltage Protector Series **BOURNS®**

## APPLICATIONS INFORMATION

### Lightning Surge (continued)

#### ITU-T 10/700 Generator (continued)

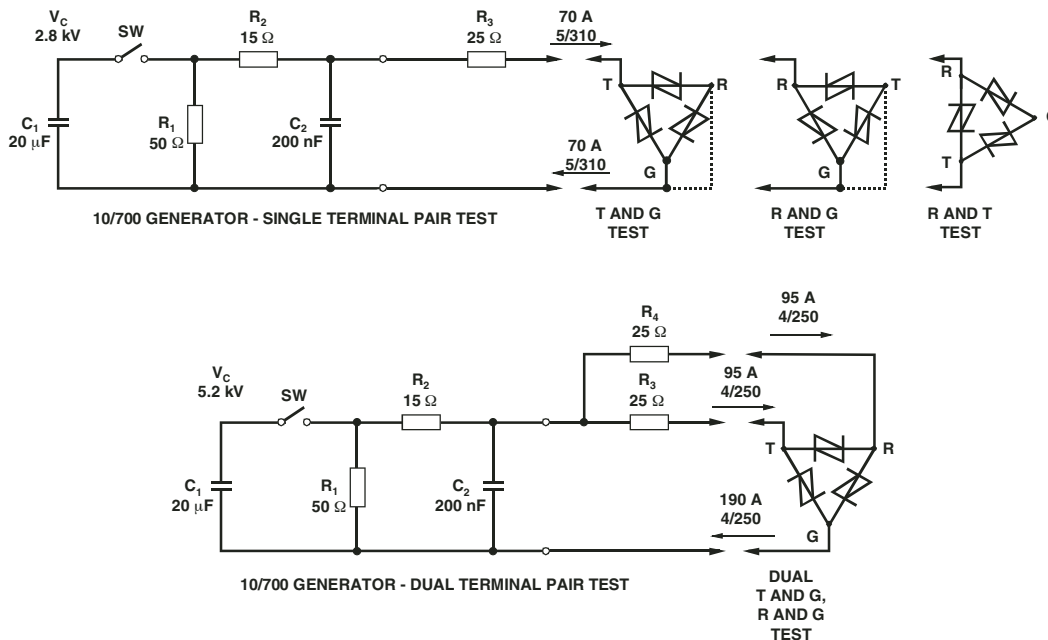

Figure 33.

With the generator output open circuit, when SW closes,  $C_1$  discharges through  $R_1$ . The decay time constant will be  $C_1 R_1$ , or  $20 \times 50 = 1000 \mu\text{s}$ . For the 50 % voltage decay time, the time constant needs to be multiplied by 0.697, giving  $0.697 \times 1000 = 697 \mu\text{s}$  which is rounded to 700  $\mu\text{s}$ .

The output rise time is controlled by the time constant of  $R_2$  and  $C_2$ , which is  $15 \times 200 = 3000 \text{ ns}$  or 3  $\mu\text{s}$ . Virtual voltage rise times are given by straight line extrapolation through the 30 % and 90 % points of the voltage waveform to zero and 100 %. Mathematically, this is equivalent to 3.24 times the time constant, which gives  $3.24 \times 3 = 9.73$  which is rounded to 10  $\mu\text{s}$ . Thus, the open circuit voltage rises in 10  $\mu\text{s}$  and decays in 700  $\mu\text{s}$ , giving the 10/700 generator its name.

When the overvoltage protector switches, it effectively shorts the generator output via the series 25  $\Omega$  resistor. Two short circuit conditions need to be considered: single output using  $R_3$  only (top circuit of Figure 33) and dual output using  $R_3$  and  $R_4$  (bottom circuit of Figure 33).

For the single test, the series combination of  $R_2$  and  $R_3$  ( $15 + 25 = 40 \Omega$ ) is in shunt with  $R_1$ . This lowers the discharge resistance from 50  $\Omega$  to 22.2  $\Omega$ , giving a discharge time constant of 444  $\mu\text{s}$  and a 50% current decay time of 309.7  $\mu\text{s}$ , which is rounded to 310  $\mu\text{s}$ .

For the rise time,  $R_2$  and  $R_3$  are in parallel, reducing the effective source resistance from 15  $\Omega$  to 9.38  $\Omega$ , giving a time constant of 1.88  $\mu\text{s}$ . Virtual current rise times are given by straight line extrapolation through the 10 % and 90 % points of the current waveform to zero and 100 %. Mathematically, this is equivalent to 2.75 times the time constant, which gives  $2.75 \times 1.88 = 5.15$ , which is rounded to 5  $\mu\text{s}$ . Thus, the short circuit current rises in 5  $\mu\text{s}$  and decays in 310  $\mu\text{s}$ , giving the 5/310 wave shape.

The series resistance from  $C_1$  to the output is 40  $\Omega$ , giving an output conductance of 25 A/kV. For each 1 kV of capacitor charge voltage, 25 A of output current will result.

For the dual test, the series combination of  $R_2$  plus  $R_3$  and  $R_4$  in parallel ( $15 + 12.5 = 27.5 \Omega$ ) is in shunt with  $R_1$ . This lowers the discharge resistance from 50  $\Omega$  to 17.7  $\Omega$ , giving a discharge time constant of 355  $\mu\text{s}$  and a 50% current decay time of 247  $\mu\text{s}$ , which is rounded to 250  $\mu\text{s}$ .

For the rise time,  $R_2$ ,  $R_3$  and  $R_4$  are in parallel, reducing the effective source resistance from 15  $\Omega$  to 6.82  $\Omega$ , giving a time constant of 1.36  $\mu\text{s}$ , which gives a current rise time of  $2.75 \times 1.36 = 3.75$ , which is rounded to 4  $\mu\text{s}$ . Thus, the short circuit current rises in 4  $\mu\text{s}$  and decays in 250  $\mu\text{s}$ , giving the 4/250 wave shape.

MARCH 1994 - REVISED JANUARY 2007

Specifications are subject to change without notice.

Customers should verify actual device performance in their specific applications.

## APPLICATIONS INFORMATION

### Lightning Surge (continued)

#### ITU-T 10/700 Generator (continued)

The series resistance from C<sub>1</sub> to an *individual* output is  $2 \times 27.5 = 55 \Omega$ , giving an output conductance of 18 A/kV. For each 1 kV of capacitor charge voltage, 18 A of output current will result.

At 25 °C, these protectors are rated at 70 A for the single terminal pair condition and 95 A for the dual condition (R and G terminals and T and G terminals). In terms of generator voltage, this gives a maximum generator setting of  $70 \times 40 = 2.8 \text{ kV}$  for the single condition and  $2 \times 95 \times 27.5 = 5.2 \text{ kV}$  for the dual condition. The higher generator voltage setting for the dual condition is due to the current waveform decay being shorter at 250  $\mu\text{s}$  compared to the 310  $\mu\text{s}$  value of the single condition.

Other ITU-T recommendations use the 10/700 generator: K.17 (11/88) "Tests on power-fed repeaters using solid-state devices in order to check the arrangements for protection from external interference" and K.21(10/96) "Resistibility of subscriber's terminal to overvoltages and overcurrents", K.30 (03/93) "Positive temperature coefficient (PTC) thermistors".

Several IEC publications use the 10/700 generator; common ones are IEC 6100-4-5 (03/95) "Electromagnetic compatibility (EMC) - Part 4: Testing and measurement techniques - Section 5: Surge immunity test" and IEC 60950 (04/ 99) "Safety of information technology equipment".

The IEC 60950 10/700 generator is carried through into other "950" derivatives. Europe is harmonized by CENELEC (Comité Européen de Normalization Electro-technique) under EN 60950 (included in the Low Voltage Directive, CE mark). US has UL (Underwriters Laboratories) 1950 and Canada CSA (Canadian Standards Authority) C22.2 No. 950.

FCC Part 68 "Connection of terminal equipment to the telephone network" (47 CFR 68) uses the 10/700 generator for Type B surge testing. Part 68 defines the open circuit voltage wave shape as 9/720 and the short circuit current wave shape as 5/320 for a single output. The current wave shape in the dual (longitudinal) test condition is not defined, but it can be assumed to be 4/250.

Several VDE publications use the 10/700 generator, for example: VDE 0878 Part 200 (12/92) "Electromagnetic compatibility of information technology equipment and telecommunications equipment; Immunity of analogue subscriber equipment".

#### 1.2/50 Generators

The 1.2/50 open circuit voltage and 8/20 short circuit current combination generator is defined in IEC 61000-4-5 (03/95) "Electromagnetic compatibility (EMC) - Part 4: Testing and measurement techniques - Section 5: Surge immunity test". This generator has a fictive output resistance of 2  $\Omega$ , meaning that dividing the open circuit output voltage by the short circuit output current gives a value of 2  $\Omega$ (500 A/kV).

The combination generator has three testing configurations; directly applied for testing between equipment a.c. supply connections, applied via an external 10  $\Omega$  resistor for testing between the a.c. supply connections and ground, and applied via an external 40  $\Omega$  resistor for testing all other lines. For unshielded unsymmetrical data or signalling lines, the combination generator is applied via a 40  $\Omega$  resistor either between lines or line to ground. For unshielded symmetrical telecommunication lines, the combination generator is applied to all lines via a resistor of  $n \times 40 \Omega$ , where  $n$  is the number of conductors and the maximum value of external feed resistance is 250  $\Omega$ . Thus, for four conductors,  $n = 4$  and the series resistance is  $4 \times 40 = 160 \Omega$ . For ten conductors, the resistance cannot be  $10 \times 40 = 400 \Omega$  and must be 250  $\Omega$ . The combination generator is used for short distance lines; long distance lines are tested with the 10/700 generator.

When the combination generator is used with a 40  $\Omega$ , or more, external resistor, the current wave shape is not 8/20, but becomes closer to the open circuit voltage wave shape of 1.2/50. For example, a commercial generator when used with 40  $\Omega$  produced an 1.4/50 wave shape.

The wave shapes of 1.2/50 and 8/20 occur in other generators as well. British Telecommunication has a combination generator with 1.2/50 voltage and 8/20 current wave shapes, but it has a fictive resistance of 1  $\Omega$ . ITU-T recommendation K.22 "Overvoltage resistibility of equipment connected to an ISDN T/S BUS" (05/95) has a 1.2/50 generator option using only resistive and capacitive elements, Figure 34.

The K.22 generator produces a 1.4/53 open circuit voltage wave. Using 25  $\Omega$  output resistors, gives a single short circuit current output wave shape of 0.8/18 with 26 A/kV and a dual of 0.6/13 with 20 A/kV. These current wave shapes are often rounded to 1/20 and 0.8/14.



# TISP7xxxF3 (MV, HV) Overvoltage Protector Series **BOURNS®**

## APPLICATIONS INFORMATION

### Lightning Surge (continued)

#### 1.2/50 Generators (continued)

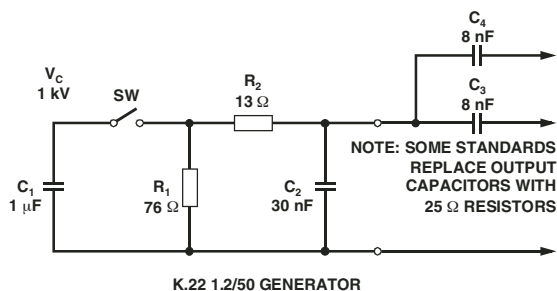

Figure 34.

There are 8/20 short circuit current defined generators. These are usually very high current, 10 kA or more and are used for testing a.c. protectors, primary protection modules and some Gas Discharge Tubes.

#### Impulse Testing

To verify the withstand capability and safety of the equipment, standards require that the equipment is tested with various impulse wave forms. The table in this section shows some common test values.

Manufacturers are being increasingly required to design in protection coordination. This means that each protector is operated at its design level and currents are diverted through the appropriate protector, e.g. the primary level current through the primary protector and lower levels of current may be diverted through the secondary or inherent equipment protection. Without coordination, primary level currents could pass through the equipment only designed to pass secondary level currents. To ensure coordination happens with fixed voltage protectors, some resistance is normally used between the primary and secondary protection (R1a and R1b, Figure 36). The values given in this data sheet apply to a 400 V (d.c. sparkover) gas discharge tube primary protector and the appropriate test voltage when the equipment is tested with a primary protector.

Standard	Peak Voltage Setting V	Voltage Waveform μs	Peak Current Value A	Current Waveform μs	TISP7xxxF3 25 °C Rating A	Series Resistance Ω	Coordination Resistance Ω (Min.)
GR-1089-CORE	2500	2/10	2 x 500	2/10	2 x 190	12	NA
	1000	10/1000	2 x 100	10/1000	2 x 45		
FCC Part 68 (March 1998)	1500	10/160	200	10/160	110	6	NA
	800	10/560	100	10/560	50	8	
	1000	9/720 † (SINGLE)	25	5/320 †	70	0	
	1500	(DUAL)	37.5	5/320 †	70	0	
I 31-24	1500	0.5/700	37.5	0.2/310	70	0	NA
	1000	10/700	25	5/310	70	0	NA
ITU-T K.20/K.21	1500	(SINGLE)	37.5	5/310	70	0	NA
	4000	(SINGLE)	100	5/310	70	17	6
	4000	(DUAL)	2 x 72	4/250	2 x 95	0	6
	4000	(DUAL)	2 x 72	4/250	2 x 95	0	6

† FCC Part 68 terminology for the waveforms produced by the ITU-T recommendation K.21 10/700 impulse generator

NA = Not Applicable, primary protection removed or not specified.

If the impulse generator current exceeds the protector's current rating, then a series resistance can be used to reduce the current to the protector's rated value to prevent possible failure. The required value of series resistance for a given waveform is given by the following calculations. First, the minimum total circuit impedance is found by dividing the impulse generator's peak voltage by the protector's rated current. The impulse generator's fictive impedance (generator's peak voltage divided by peak short circuit current) is then subtracted from the minimum total circuit impedance to give the required value of series resistance. In some cases, the equipment will require verification over a temperature range. By using the derated waveform values from the thermal information section, the appropriate series resistor value can be calculated for ambient temperatures in the range of 0 °C to 70 °C.

MARCH 1994 - REVISED JANUARY 2007

Specifications are subject to change without notice.  
Customers should verify actual device performance in their specific applications.

## APPLICATIONS INFORMATION

## Protection Voltage

The protection voltage, ( $V_{(BO)}$ ), increases under lightning surge conditions due to thyristor regeneration. This increase is dependent on the rate of current rise,  $di/dt$ , when the TISP® device is clamping the voltage in its breakdown region. The  $V_{(BO)}$  value under surge conditions can be estimated by multiplying the 50 Hz rate  $V_{(BO)}$  (250 V/ms) value by the normalized increase at the surge's  $di/dt$ . An estimate of the  $di/dt$  can be made from the surge generator voltage rate of rise,  $dv/dt$ , and the circuit resistance.

As an example, the ITU-T recommendation K.21 1.5 kV, 10/700 surge has an average  $dv/dt$  of 150 V/ $\mu$ s, but, as the rise is exponential, the initial  $dv/dt$  is three times higher, being 450 V/ $\mu$ s. The instantaneous generator output resistance is 25  $\Omega$ . If the equipment has an additional series resistance of 20  $\Omega$ , the total series resistance becomes 45  $\Omega$ . The maximum  $di/dt$  then can be estimated as  $450/45 = 10$  A/ $\mu$ s. In practice, the measured  $di/dt$  and protection voltage increase will be lower due to inductive effects and the finite slope resistance of the TISP® breakdown region.

## Capacitance

## Off-State Capacitance

The off-state capacitance of a TISP® device is sensitive to junction temperature,  $T_J$ , and the bias voltage, comprising of the dc voltage,  $V_D$ , and the ac voltage,  $V_d$ . All the capacitance values in this data sheet are measured with an ac voltage of 1 Vrms. When  $V_D \gg V_d$ , the capacitance value is independent on the value of  $V_d$ . Up to 10 MHz, the capacitance is essentially independent of frequency. Above 10 MHz, the effective capacitance is strongly dependent on connection inductance. For example, a printed wiring (PW) trace of 10 cm could create a circuit resonance with the device capacitance in the region of 80 MHz.

## Longitudinal Balance

Figure 35 shows a three terminal TISP® device with its equivalent "delta" capacitance. Each capacitance,  $C_{TG}$ ,  $C_{RG}$  and  $C_{TR}$ , is the true terminal pair capacitance measured with a three terminal or guarded capacitance bridge. If wire R is biased at a larger potential than wire T, then  $C_{TG} > C_{RG}$ . Capacitance  $C_{TG}$  is equivalent to a capacitance of  $C_{RG}$  in parallel with the capacitive difference of  $(C_{TG} - C_{RG})$ . The line capacitive unbalance is due to  $(C_{TG} - C_{RG})$  and the capacitance shunting the line is  $C_{TR} + C_{RG}/2$ .

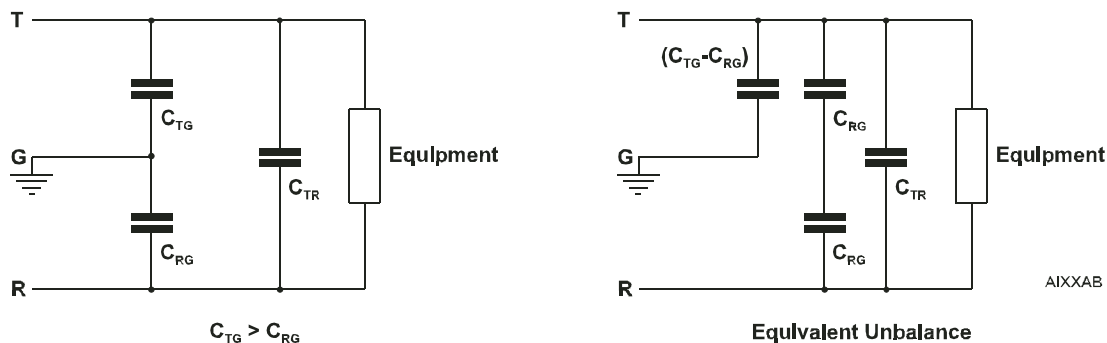

Figure 35.

All capacitance measurements in this data sheet are three terminal guarded to allow the designer to accurately assess capacitive unbalance effects. Simple two terminal capacitance meters (unguarded third terminal) give false readings as the shunt capacitance via the third terminal is included.

# TISP7xxxF3 (MV, HV) Overvoltage Protector Series **BOURNS**<sup>®</sup>

## Typical Circuits

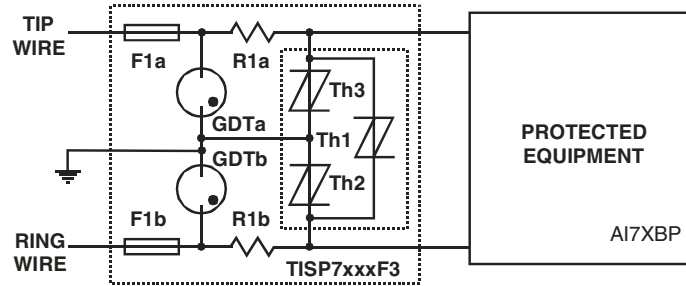

Figure 36. Protection Module

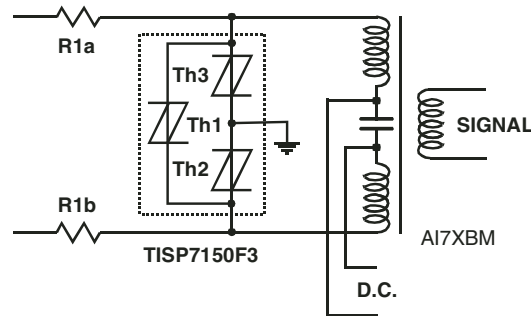

Figure 37. ISDN Protection

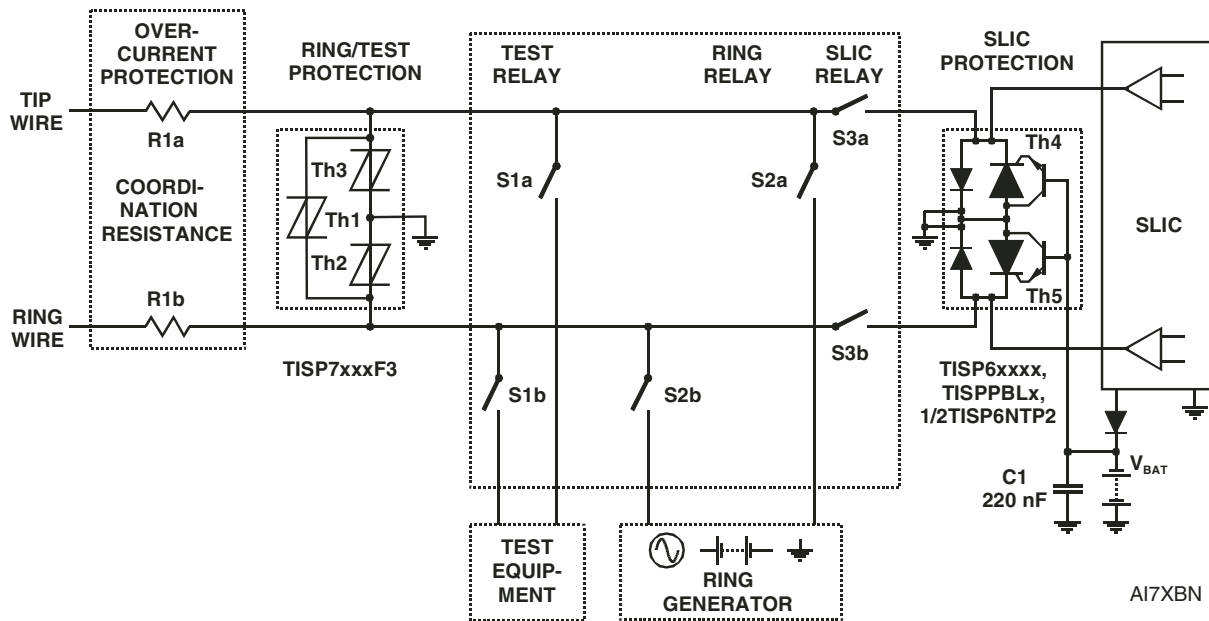

Figure 38. Line Card Ring/Test Protection

"TISP" is a trademark of Bourns, Ltd., a Bourns Company, and is Registered in U.S. Patent and Trademark Office. "Bourns" is a registered trademark of Bourns, Inc. in the U.S. and other countries.

MARCH 1994 - REVISED JANUARY 2007

Specifications are subject to change without notice. Customers should verify actual device performance in their specific applications.