



MMDT4413

COMPLEMENTARY NPN/PNP SMALL SIGNAL SURFACE MOUNT TRANSISTOR

VOLTAGE 40 Volts **POWER** 225 mWatts

SOT-363 Unit: inch (mm)

FEATURES

- Complementary Pair
- One 4401-Type NPN
- One 4403-Type PNP
- Epitaxial Planar Die Construction
- Ideal for Low Power Amplification and Switching
- Ultra-Small Surface Mount Package
- Also Available in Lead Free Version
- In compliance with EU RoHS 2002/95/EC directives

MECHANICAL DATA

- Case: SOT-363, Plastic
- Terminals: Solderable per MIL-STD-750, Method 2026
- Approx. Weight: 0.006 gram
- Marking: M6A

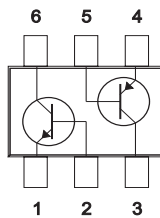
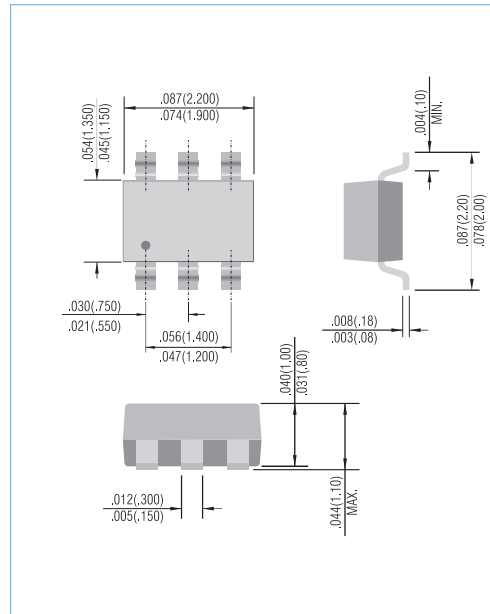

Fig.55

MAXIMUM RATINGS, TOTAL DEVICE @ $T_A = 25^\circ\text{C}$ UNLESS OTHERWISE SPECIFIED

Characteristic	Symbol	Value	Unit
Power Dissipation	P_d	225	mW
Thermal Resistance , Junction to Ambient	$R_{\theta A}$	625	K/W
Operating and Storage and Junction Range	T_J, T_{STG}	-55 to 150	$^\circ\text{C}$



MMDT4413

MAXIMUM RATINGS,NPN 4401 SECTION @ $T_A=25^{\circ}\text{C}$ UNLESS OTHERWISE SPECIFIED

Characteristic	Symbol	NPN4401	Unit
Collector-Base Voltage	V_{CB0}	60	V
Collector-Emitter Voltage	V_{CE0}	40	V
Emitter-Base Voltage	V_{EB0}	6.0	V
Collector Current-Continuous	I_c	600	mA

MAXIMUM RATINGS,NPN 4403 SECTION @ $T_A=25^{\circ}\text{C}$ UNLESS OTHERWISE SPECIFIED

Characteristic	Symbol	PNP4403	Unit
Collector-Base Voltage	V_{CB0}	-40	V
Collector-Emitter Voltage	V_{CE0}	-40	V
Emitter-Base Voltage	V_{EB0}	-5.0	V
Collector Current-Continuous	I_c	-600	mA



MMDT4413

ELECTRICAL CHARACTERISTICS, NPN 4401 SECTION @ TA=25°C UNLESS OTHERWISE SPECIFIED

CHARACTERISTIC	SYMBOL	TEST CONDITION	MIN	MAX	UNIT
OFF CHARACTERISTIC					
Collector - Base Breakdown Voltage	$V_{(BR)CBO}$	$I_C=100\mu A, I_E=0$	60	-	V
Collector - Emitter Breakdown Voltage	$V_{(BR)CEO}$	$I_C=1.0mA, I_B=0$	40	-	V
Emitter - Base Breakdown Voltage	$V_{(BR)EBO}$	$I_E=100\mu A, I_C=0$	6.0	-	V
Collector Cutoff Current	I_{cEX}	$V_{CE}=35V, V_{EB(OFF)}=0.4V$	-	100	nA
Base Cutoff Current	I_{BL}	$V_{CE}=35V, V_{EB(OFF)}=0.4V$	-	100	nA
ON CHARACTERISTICS					
DC Current Gain (Note 2)	h_{FE}	$I_C=100\mu A, V_{CE}=1.0V$	20	-	-
		$I_C=1.0mA, V_{CE}=1.0V$	40	-	
		$I_C=10mA, V_{CE}=1.0V$	80	-	
		$I_C=150mA, V_{CE}=1.0V$	100	300	
		$I_C=500mA, V_{CE}=2.0V$	40	-	
Collector - Emitter Saturation Voltage	$V_{CE(SAT)}$	$I_C=150mA, I_B=15mA$ $I_C=500mA, I_B=50mA$	-	0.40 0.75	V
Base - Emitter Saturation Voltage	$V_{BE(SAT)}$	$I_C=150mA, I_B=15mA$ $I_C=500mA, I_B=50mA$	0.75 -	0.95 1.20	V
SMALL SIGNAL CHARACTERISTICS					
Output Capacitance	C_{cb}	$V_{CB}=5V, I_E=0, f=1.0MHz$	-	6.5	pF
Input Capacitance	C_{eb}	$V_{EB}=0.5V, I_C=0, f=1MHz$	-	30	pF
Input Impedance	h_{ie}	$V_{CE}=10V, I_C=1.0mA, f=1.0KHz$	1.0	15	k Ω
Voltage Feedback Ratio	h_{re}		0.1	8.0	$\times 10^{-4}$
Small Signal Current Gain	h_{fe}		40	500	-
Output Admittance	h_{oe}		1.0	30	μS
Current Gain - Bandwidth Product	f_T		$V_{CE}=10V, I_C=20mA, f=100MHz$	250	-
SWITCHING CHARACTERISTICS					
Delay Time	t_d	$V_{CC}=30V, V_{BE(OFF)}=2.0V,$ $I_C=150mA, I_{B1}=15mA$	-	15	ns
Rise Time	t_r		-	20	ns
Storage Time	t_s	$V_{CC}=30V, I_C=150mA$ $I_{B1}=I_{B2}=15mA$	-	225	ns
Fall Time	t_f		-	30	ns



MMDT4413

ELECTRICAL CHARACTERISTICS, NPN 4403 SECTION @ TA=25°C UNLESS OTHERWISE SPECIFIED

CHARACTERISTIC	SYMBOL	TEST CONDITION	MIN	MAX	UNIT
OFF CHARACTERISTIC					
Collector - Base Breakdown Voltage	$V_{(BR)CBO}$	$I_C = -100\mu A, I_E = 0$	-40	-	V
Collector - Emitter Breakdown Voltage	$V_{(BR)CEO}$	$I_C = -1.0mA, I_B = 0$	-40	-	V
Emitter - Base Breakdown Voltage	$V_{(BR)EBO}$	$I_E = -100\mu A, I_C = 0$	-5.0	-	V
Collector Cutoff Current	I_{CEX}	$V_{CE} = -35V, V_{EB(OFF)} = -0.4V$	-	-100	nA
Base Cutoff Current	I_{BL}	$V_{CE} = -35V, V_{EB(OFF)} = -0.4V$	-	-100	nA
ON CHARACTERISTICS					
DC Current Gain (Note 2)	h_{FE}	$I_C = -100\mu A, V_{CE} = -1.0V$ $I_C = -1.0mA, V_{CE} = -1.0V$ $I_C = -10mA, V_{CE} = -1.0V$ $I_C = -150mA, V_{CE} = -2.0V$ $I_C = -500mA, V_{CE} = -2.0V$	30 60 100 100 20	- - - 300 -	-
Collector - Emitter Saturation Voltage	$V_{CE(SAT)}$	$I_C = -150mA, I_B = -15mA$ $I_C = -500mA, I_B = -50mA$	-	-0.40 -0.75	V
Base - Emitter Saturation Voltage	$V_{BE(SAT)}$	$I_C = -150mA, I_B = -15mA$ $I_C = -500mA, I_B = -50mA$	-0.75 -	-0.95 -1.30	V
SMALL SIGNAL CHARACTERISTICS					
Output Capacitance	C_{cb}	$V_{CB} = -10V, I_E = 0, f = 1.0MHz$	-	8.5	pF
Input Capacitance	C_{eb}	$V_{EB} = -0.5V, I_C = 0, f = 1MHz$	-	30	pF
Input Impedance	h_{ie}	$V_{CE} = -10V, I_C = -1.0mA, f = 1.0KHz$	1.5	15	k Ω
Voltage Feedback Ratio	h_{re}		0.1	8.0	$\times 10^{-4}$
Small Signal Current Gain	h_{fe}		60	500	-
Output Admittance	h_{oe}		1.0	100	μS
Current Gain - Bandwidth Product	f_T		$V_{CE} = -10V, I_C = -20mA, f = 100MHz$	200	-
SWITCHING CHARACTERISTICS					
Delay Time	t_d	$V_{CC} = -30V, V_{BE(OFF)} = -2.0V,$ $I_C = -150mA, I_{B1} = -15mA$	-	15	ns
Rise Time	t_r		-	20	ns
Storage Time	t_s	$V_{CC} = -30V, I_C = -150mA$ $I_{B1} = I_{B2} = -15mA$	-	225	ns
Fall Time	t_f		-	30	ns



MMDT4413

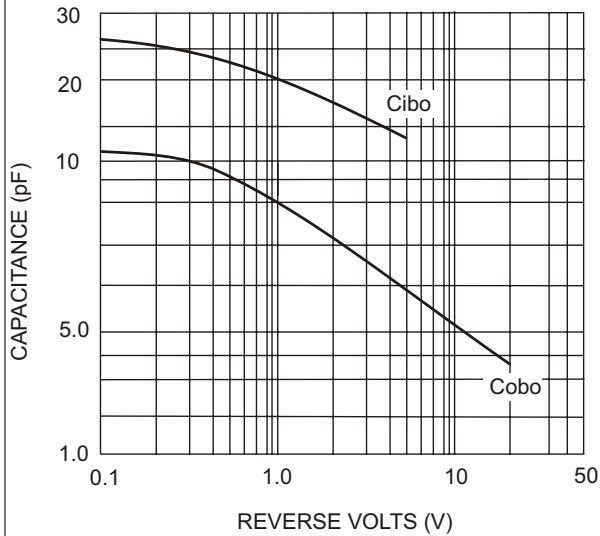

Fig. 1 Typical Capacitance (4401)

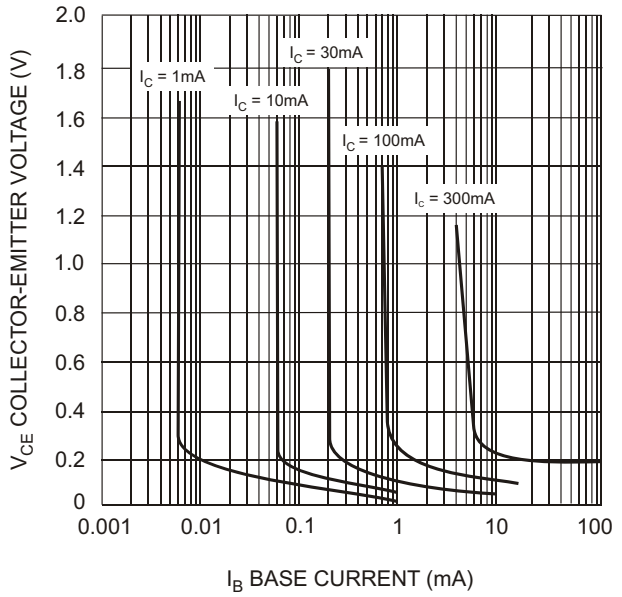

Fig. 2 Typical Collector Saturation Region (4401)

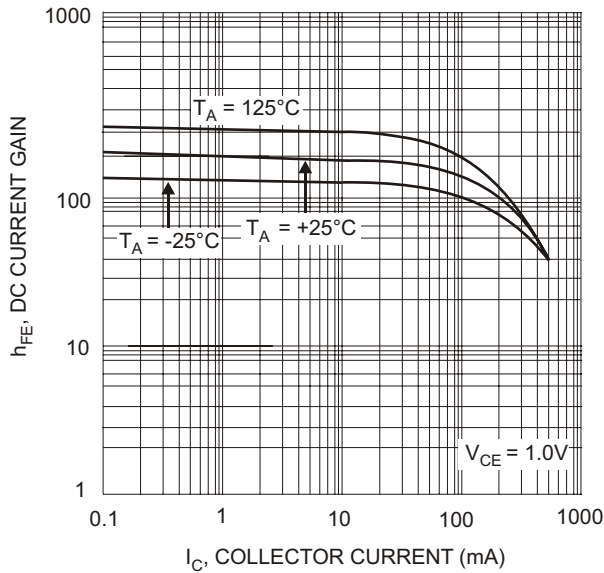

Fig. 3 Typical DC Current Gain vs. Collector Current (4401)

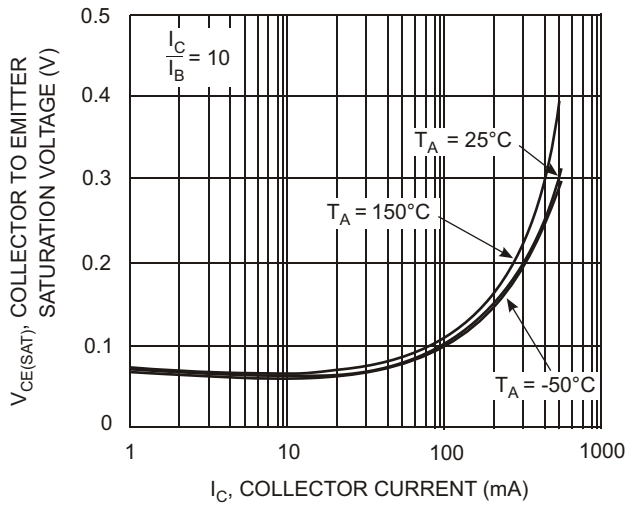

Fig. 4 Collector Emitter Saturation Voltage vs. Collector Current (4401)



MMDT4413

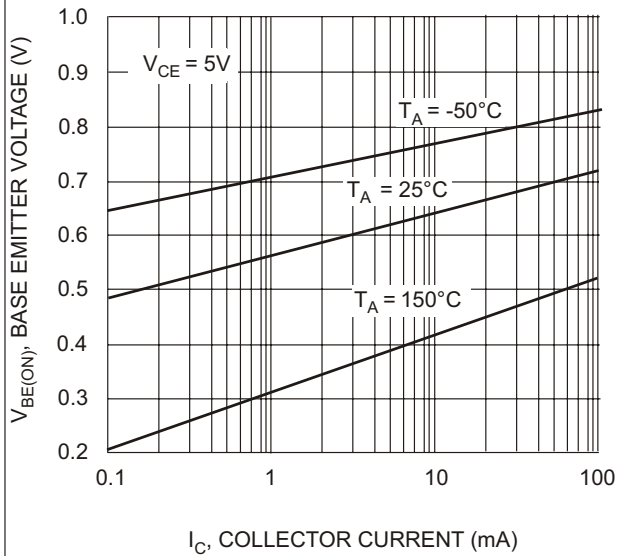

Fig. 5 Base Emitter Voltage vs. Collector Current (4401)

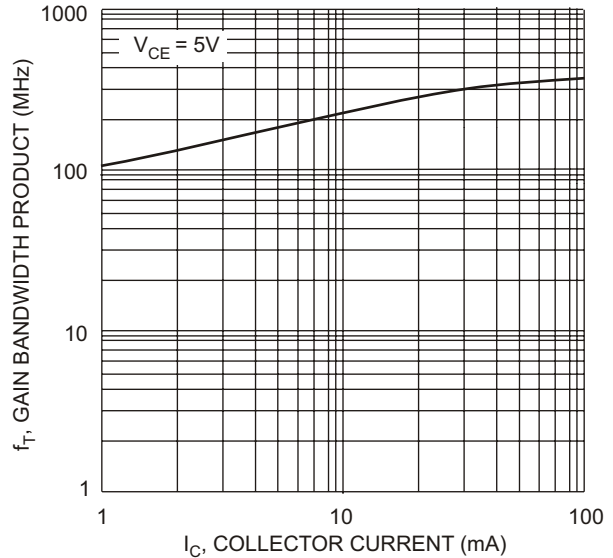

Fig. 6 Gain Bandwidth Product vs. Collector Current (4401)

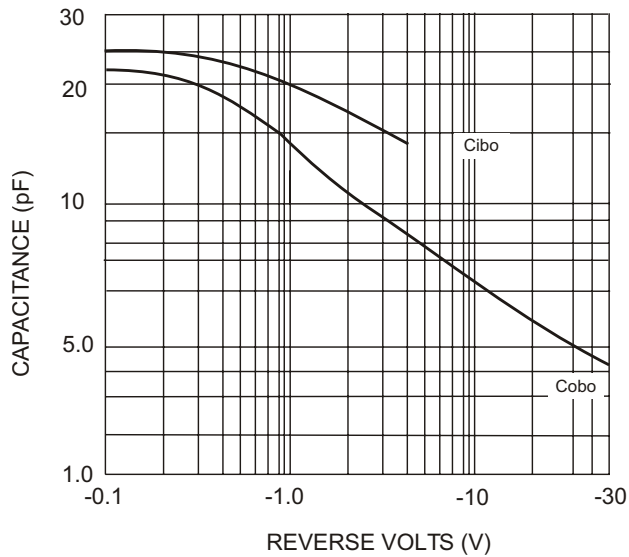

Fig. 7 Typical Capacitance (4403)



MMDT4413

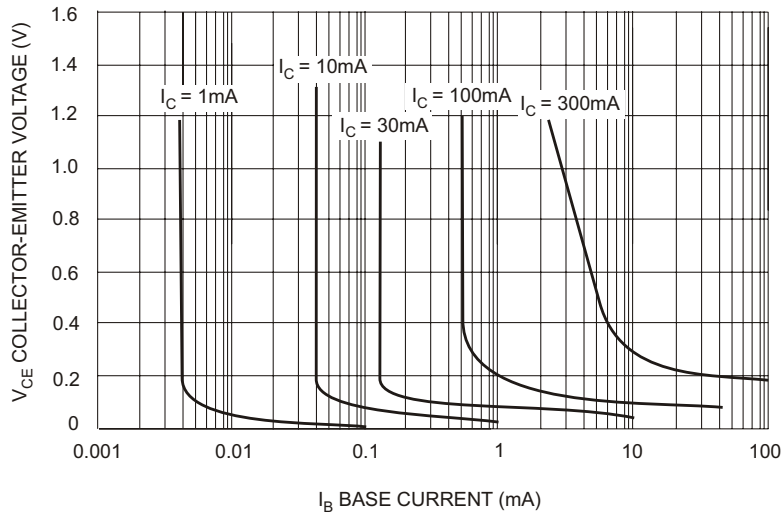

Fig. 8 Typical Collector Saturation Region (4403)

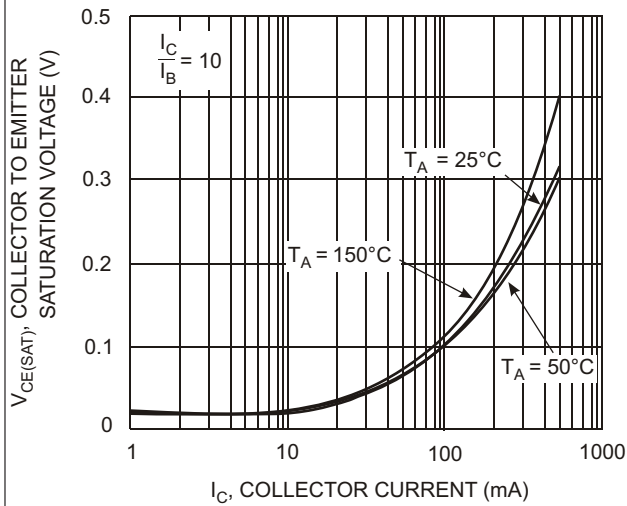

Fig. 9 Collector Emitter Saturation Voltage vs. Collector Current (4403)

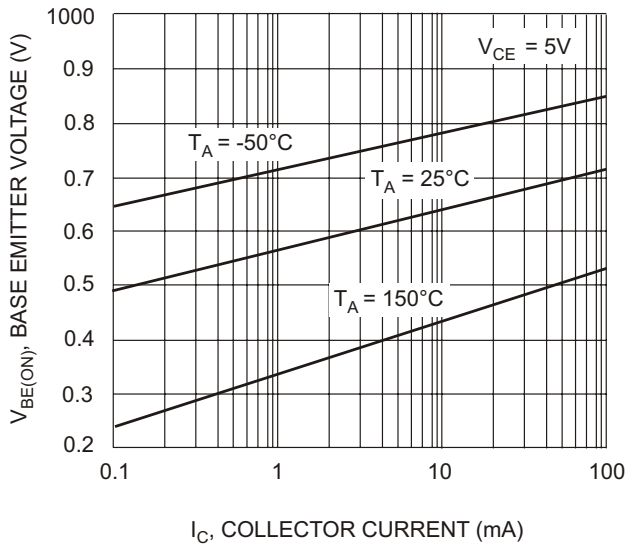

Fig. 10 Base-Emitter Voltage vs. Collector Current (4403)



MMDT4413

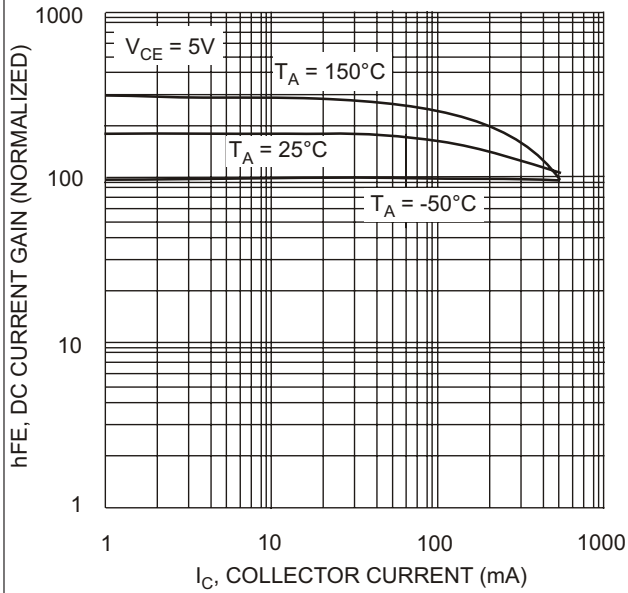

Fig. 11 DC Current Gain vs. Collector Current (4403)

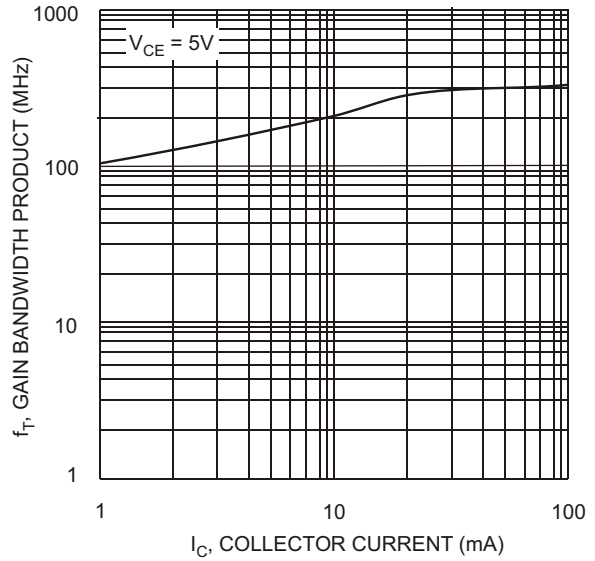

Fig. 12 Gain Bandwidth Product vs. Collector Current (4403)

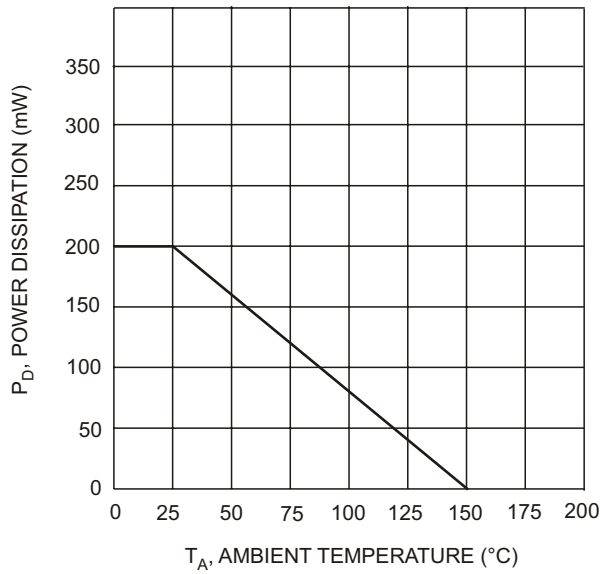
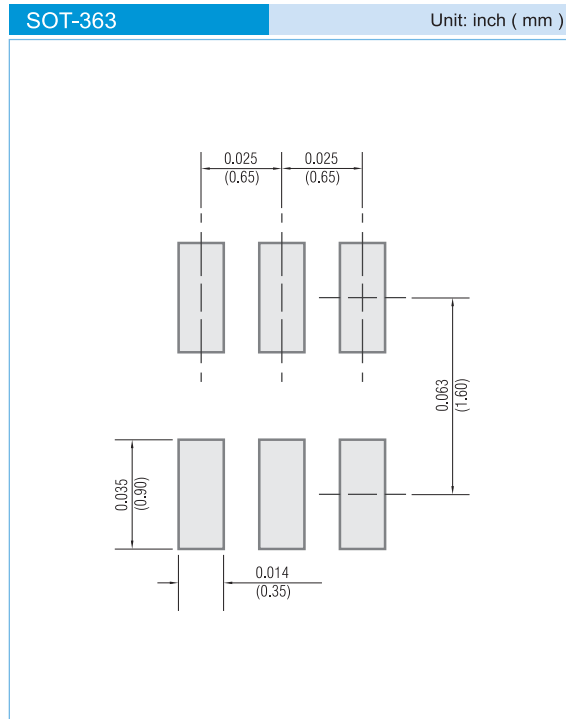

Fig. 13, Max Power Dissipation vs Ambient Temperature (4403)



MMDT4413

MOUNTING PAD LAYOUT



ORDER INFORMATION

- Packing information
 - T/R - 10K per 13" plastic Reel
 - T/R - 3K per 7" plastic Reel

LEGAL STATEMENT

Copyright PanJit International, Inc 2007

The information presented in this document is believed to be accurate and reliable. The specifications and information herein are subject to change without notice. Pan Jit makes no warranty, representation or guarantee regarding the suitability of its products for any particular purpose. Pan Jit products are not authorized for use in life support devices or systems. Pan Jit does not convey any license under its patent rights or rights of others.