



PRODUCT SPECIFICATION

Model No : CSHV-NL60xWG4-A7

Descriptions:	
• LED Type	: High Power VEGA
• LED Package	: Lambertian
• Emitting Color	: SW / WW
• Viewing Angle	: 120°
• Encapsulating	: Silicone LENS



CUSTOMER APPROVED SIGNATURES	APPROVED BY	CHECKED BY	PREPARED BY
	 李 CSC 榮泰	 張 CSC 坤政	 馬 CSC 仁倫

CHINA SEMICONDUCTOR CORPORATION
 Address : 2FL. NO.909,Chung-Cheng Road,
 Chung-Ho City Taipei Hsien,Taiwan.

OPTO PLUS TECHNOLOGIES CO.,LTD
 Address : 696 Shun jiang Rd.,Ji Shan St.Shaoxing,
 ZheJiang,China

Tel : 886-2-2223-9696

Tel : 86-0575-88623888

Fax : 886-2-2223-9377

Fax : 86-0575-88623112

<http://www.csctw.com.tw>



Spec. No.	PS-0905-001
Rev.	A

■ **Features –**

1. High Luminous Output
2. Silicone Encapsulation
3. RoHs Compliant
4. Compatible Lead-Free Reflow Solder
5. ESD>8KV(HBM)
6. Standard Collimator Compatible
7. Low thermal resistance (junction to Case) : 10 °C/W

■ **Device Selection Guide –**

Part No.	Chip		LED Lens
	Material	Emitted Color	
CSHV-NL60SWG4-A7	InGaN/Sapphire	Standard White	Water Transparent
CSHV-NL60WWG4-A7		Warm White	

■ **Absolute Maximum Rating –**

(Ta=25°C)

Parameter	Symbol	Rating	Unit
Power Dissipation	Pd	2	W
Forward Current (DC)	IF	500	mA
Peak Forward Current *	IFP	700	mA
Reverse Voltage	VR	5	V
Operating Temp.	Topr	-40 ~ +85	°C
Storage Temp.	Tstg	-40 ~ +100	°C

* Pulse width ≤ 0.1 msec. duty $\leq 1/10$

Spec. No.	PS-0905-001
Rev.	A

■ Package Outline Dimensions –

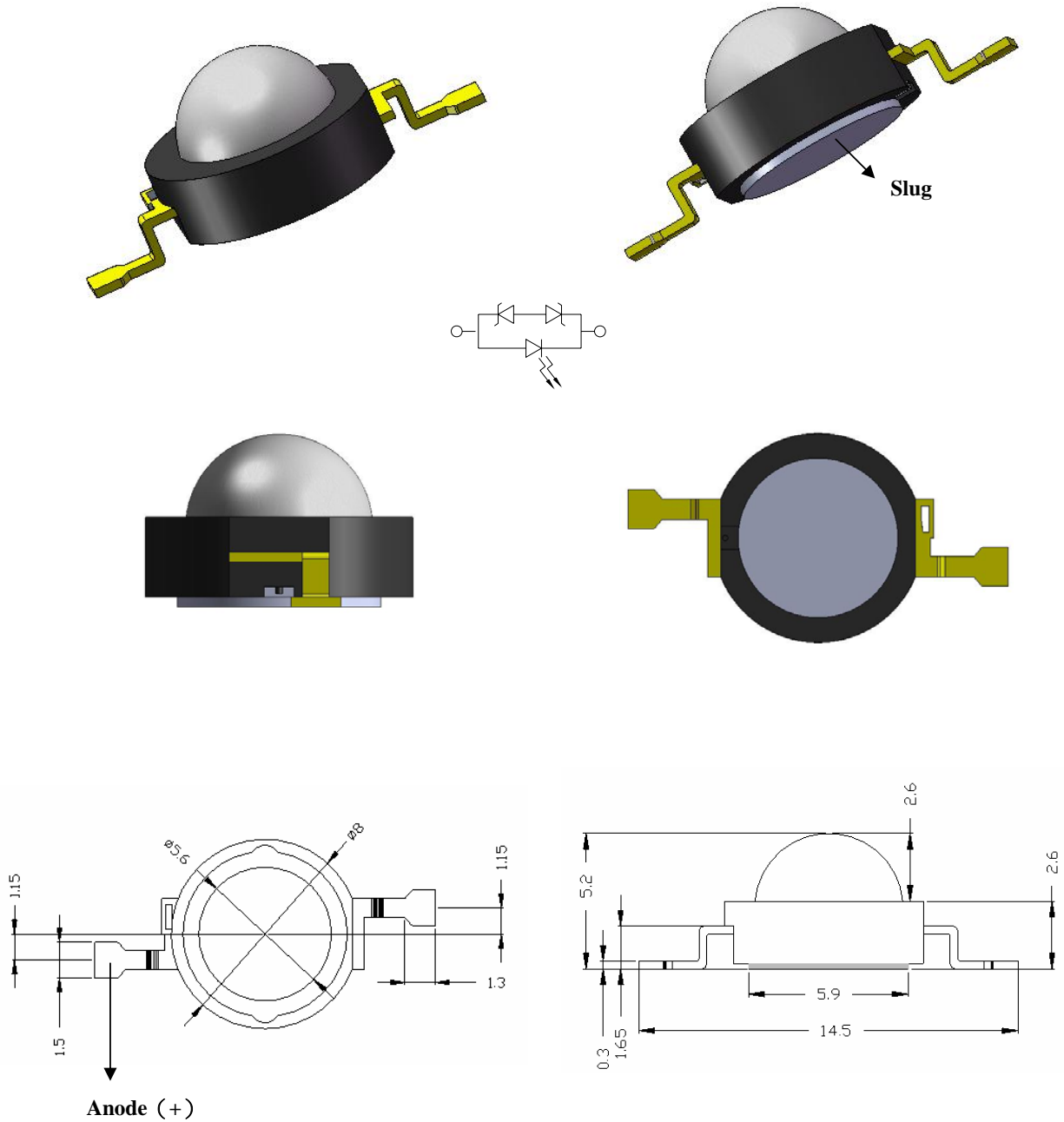

Notes: Tolerance of measurement of Dimension: $\pm 0.25\text{mm}$

■ **Electrical / Optical Characteristics –**

(Ta=25°C)

Parameter	Symbol	Min.	Typ.	Max.	Unit	Condition
Forward Voltage	VF		3.4	4	V	IF=350mA
Luminous Flux	Φv	70	90		lm	
Viewing Angle	2θ 1/2		120		deg	
Reverse Current	IR			50	μA	VR=5V

■ **Luminous Flux Rank Limits (IF = 350mA)**

unit : lm

Luminous Flux Part No.	70-80	80-90	90-100	100-120
	CSHV-NL60SWG4-A7	L	M	N
CSHV-NL60WWG4-A7	L	M	N	P

■ **Color Rank Limits (IF = 350mA)**

CSHV-NL60SWG4-A7

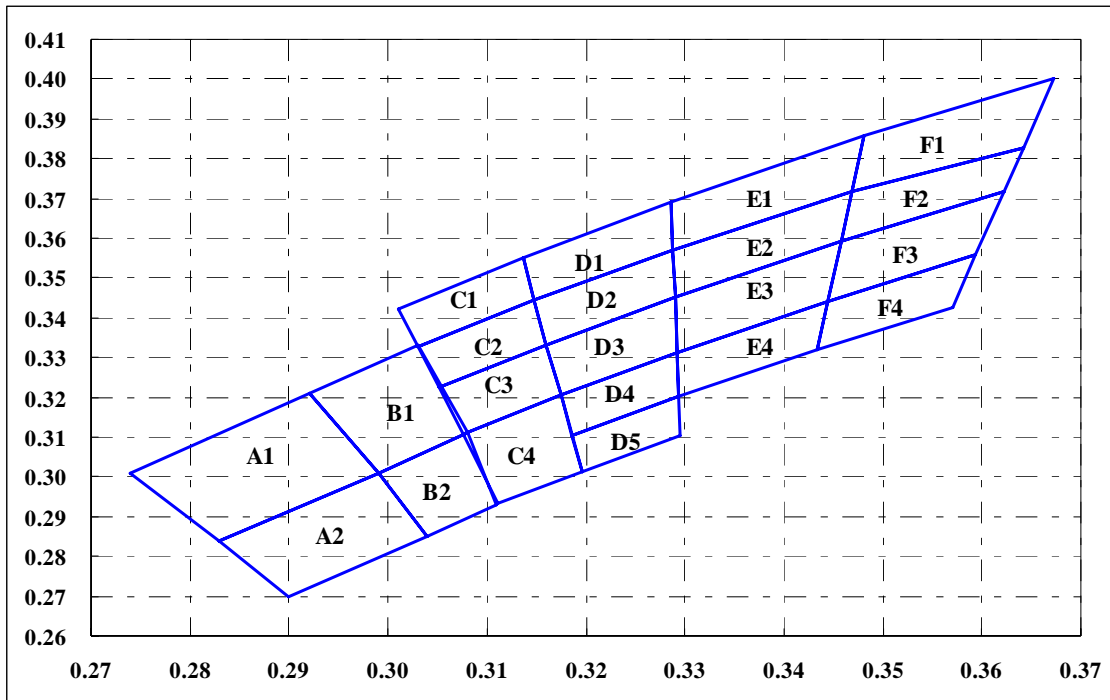

Rank A Color Temperature:8000~10000K									
A1					A2				
X	0.2920	0.2740	0.2830	0.2990	X	0.3040	0.2900	0.2830	0.2990
Y	0.3210	0.3010	0.2840	0.3010	Y	0.2850	0.2700	0.2840	0.3010

Rank B Color Temperature:6700~8000K									
B1					B2				
X	0.2990	0.2920	0.3030	0.3080	X	0.3040	0.2990	0.3080	0.3110
Y	0.3010	0.3210	0.3330	0.3110	Y	0.2850	0.3010	0.3110	0.2930

Rank C Color Temperature:6000~6700K									
C1					C3				
X	0.3011	0.3136	0.3148	0.3031	X	0.3052	0.3160	0.3175	0.3076
Y	0.3422	0.3550	0.3444	0.3327	Y	0.3224	0.3332	0.3204	0.3108
C2					C4				
X	0.3031	0.3148	0.3160	0.3052	X	0.3076	0.3175	0.3196	0.3112
Y	0.3327	0.3444	0.3332	0.3224	Y	0.3108	0.3204	0.3013	0.2932



Spec. No.	PS-0905-001
Rev.	A

Rank D Color Temperature:5300~6000K									
D1					D4				
X	0.3136	0.3286	0.3288	0.3148	X	0.3175	0.3292	0.3294	0.3186
Y	0.3550	0.3690	0.3569	0.3444	Y	0.3204	0.3313	0.3202	0.3102
D2					D5				
X	0.3148	0.3288	0.3290	0.3160	X	0.3186	0.3294	0.3295	0.3196
Y	0.3444	0.3569	0.3451	0.3332	Y	0.3102	0.3202	0.3105	0.3013
D3									
X	0.3160	0.3290	0.3292	0.3175					
Y	0.3332	0.3451	0.3313	0.3204					

Rank E Color Temperature:4750~5300K									
E1					E3				
X	0.3286	0.3481	0.3469	0.3288	X	0.3290	0.3458	0.3444	0.3292
Y	0.3690	0.3856	0.3717	0.3569	Y	0.3451	0.3592	0.3442	0.3313
E2					E4				
X	0.3288	0.3469	0.3458	0.3290	X	0.3292	0.3444	0.3434	0.3294
Y	0.3569	0.3717	0.3592	0.3451	Y	0.3313	0.3442	0.3320	0.3202

Rank F Color Temperature:4300~4750K									
F1					F3				
X	0.3481	0.3673	0.3642	0.3469	X	0.3458	0.3622	0.3594	0.3444
Y	0.3856	0.4003	0.3829	0.3717	Y	0.3592	0.3716	0.3557	0.3442
F2					F4				
X	0.3469	0.3642	0.3622	0.3458	X	0.3444	0.3594	0.3571	0.3434
Y	0.3717	0.3829	0.3716	0.3592	Y	0.3442	0.3557	0.3426	0.3320

CSHV-NL60WWG4-A7

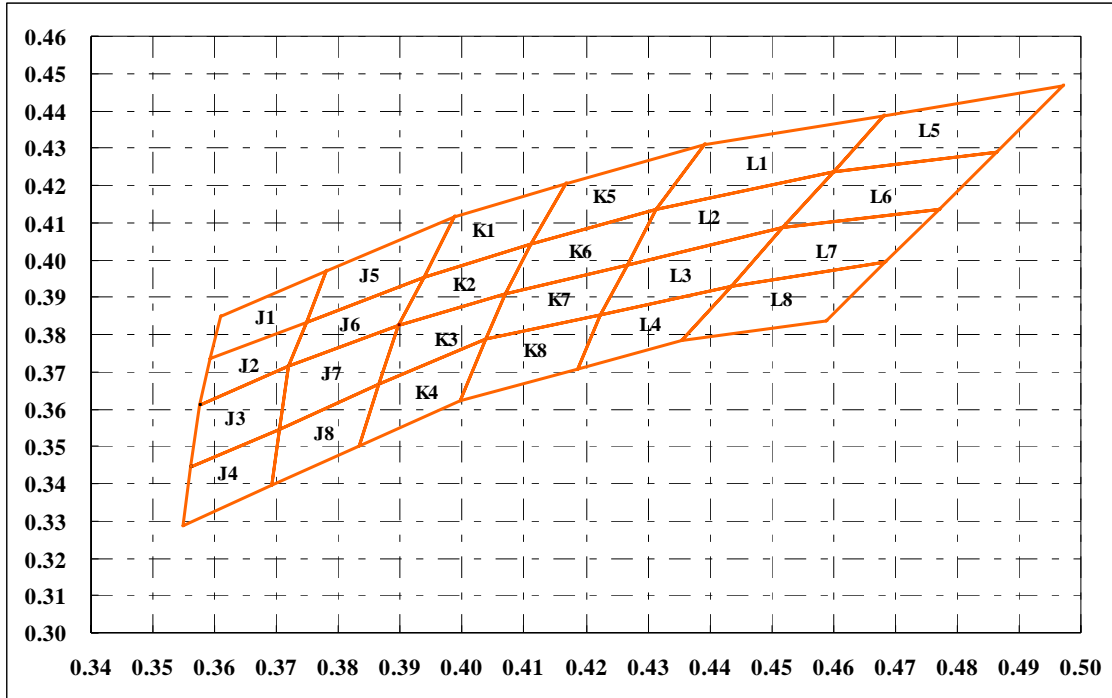

Rank J Color Temperature:3800~4600K									
J1					J5				
X	0.3593	0.3610	0.3780	0.3748	X	0.3748	0.3780	0.3988	0.3938
Y	0.3736	0.3850	0.3970	0.3834	Y	0.3834	0.3970	0.4116	0.3954
J2					J6				
X	0.3575	0.3593	0.3748	0.3720	X	0.3720	0.3748	0.3938	0.3897
Y	0.3612	0.3736	0.3834	0.3714	Y	0.3714	0.3834	0.3954	0.3823
J3					J7				
X	0.3561	0.3575	0.3720	0.3705	X	0.3705	0.3720	0.3897	0.3866
Y	0.3445	0.3612	0.3714	0.3544	Y	0.3544	0.3714	0.3823	0.3666
J4					J8				
X	0.3548	0.3561	0.3705	0.3692	X	0.3692	0.3705	0.3866	0.3834
Y	0.3285	0.3445	0.3544	0.3394	Y	0.3394	0.3544	0.3666	0.3501

Rank K Color Temperature:3175~3800K									
K1					K5				
X	0.3938	0.3988	0.4167	0.4112	X	0.4112	0.4167	0.4390	0.4314
Y	0.3954	0.4116	0.4203	0.4043	Y	0.4043	0.4203	0.4310	0.4135
K2					K6				
X	0.3897	0.3938	0.4112	0.4069	X	0.4069	0.4112	0.4314	0.4267
Y	0.3823	0.3954	0.4043	0.3908	Y	0.3908	0.4043	0.4135	0.3986
K3					K7				
X	0.3866	0.3897	0.4069	0.4037	X	0.4037	0.4069	0.4267	0.4222
Y	0.3666	0.3823	0.3908	0.3786	Y	0.3786	0.3908	0.3986	0.3853
K4					K8				
X	0.3834	0.3866	0.4037	0.3996	X	0.3996	0.4037	0.4222	0.4186
Y	0.3501	0.3666	0.3786	0.3624	Y	0.3624	0.3786	0.3853	0.3709

Rank L Color Temperature:2500~3175K									
L1					L5				
X	0.4314	0.4390	0.4680	0.4601	X	0.4601	0.4680	0.4970	0.4863
Y	0.4135	0.4310	0.4385	0.4238	Y	0.4238	0.4385	0.4466	0.4290
L2					L6				
X	0.4267	0.4314	0.4601	0.4519	X	0.4519	0.4601	0.4863	0.4770
Y	0.3986	0.4135	0.4238	0.4086	Y	0.4086	0.4238	0.4290	0.4137
L3					L7				
X	0.4222	0.4267	0.4519	0.4434	X	0.4434	0.4519	0.4770	0.4683
Y	0.3853	0.3986	0.4086	0.3930	Y	0.3930	0.4086	0.4137	0.3995
L4					L8				
X	0.4186	0.4222	0.4434	0.4355	X	0.4355	0.4434	0.4683	0.4588
Y	0.3709	0.3853	0.3930	0.3785	Y	0.3785	0.3930	0.3995	0.3838

Notes :

1. Tolerance of measurement of luminous Flux : $\pm 10\%$
2. Tolerance of measurement of Color Coordinates : ± 0.01
3. All data are measured by CSC's test equipment.
4. Please confirm with CSC sales , if your request different from standard specification.

■ **Typical Electrical / Optical Characteristics Curves –**
($T_a = 25^\circ\text{C}$ Unless Otherwise Noted)

Figure 1. Relative Luminous FLux vs. Forward Current

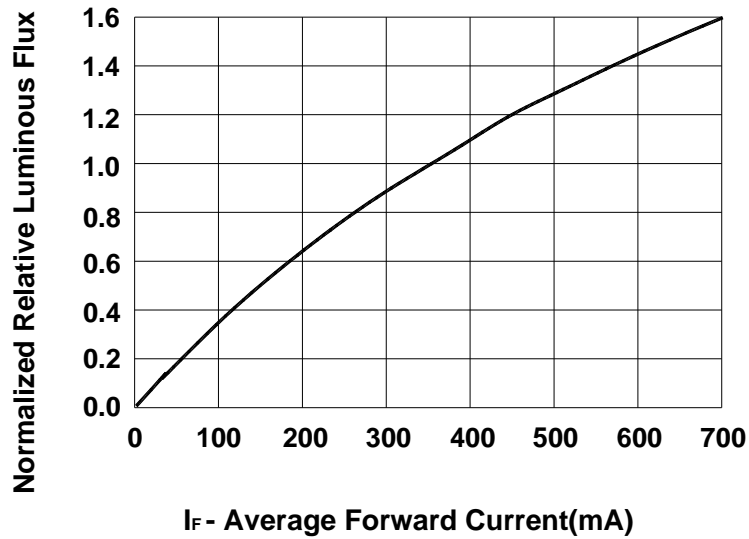
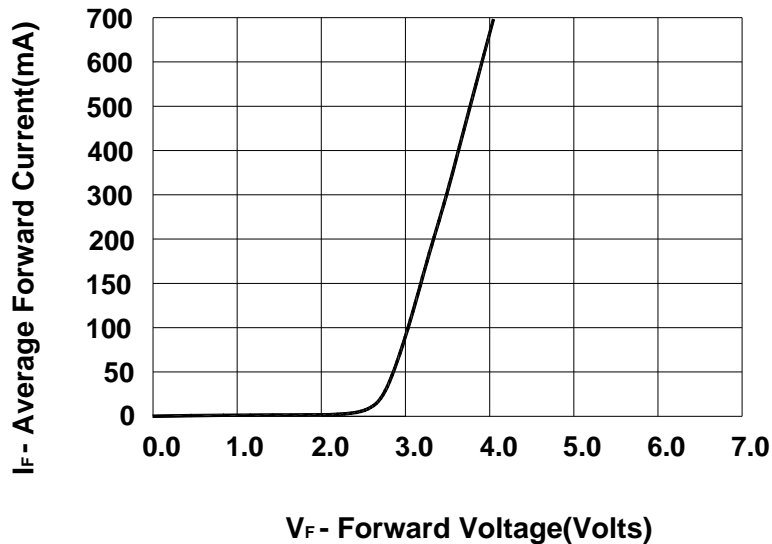

Figure 2. Forward Current vs. Forward Voltage



**Figure 3. Maximum Forward Current vs. Ambient Temperature.
Derating based on $T_{JMAX}=120^{\circ}C$**

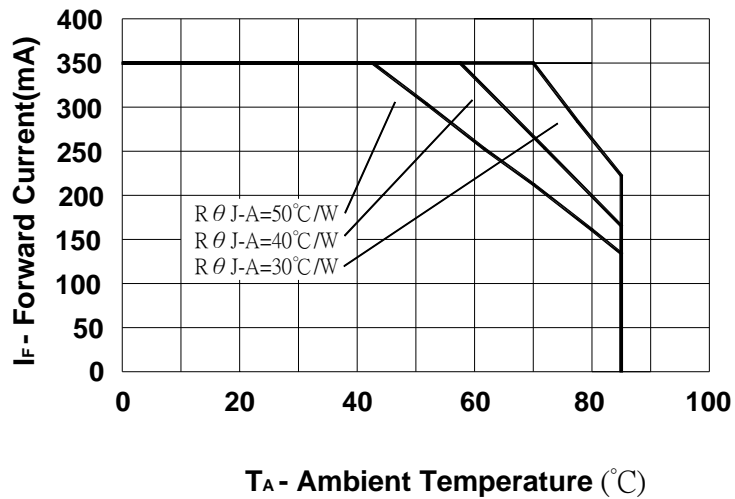

Figure 4. Relative Light Output vs. Junction Temperature

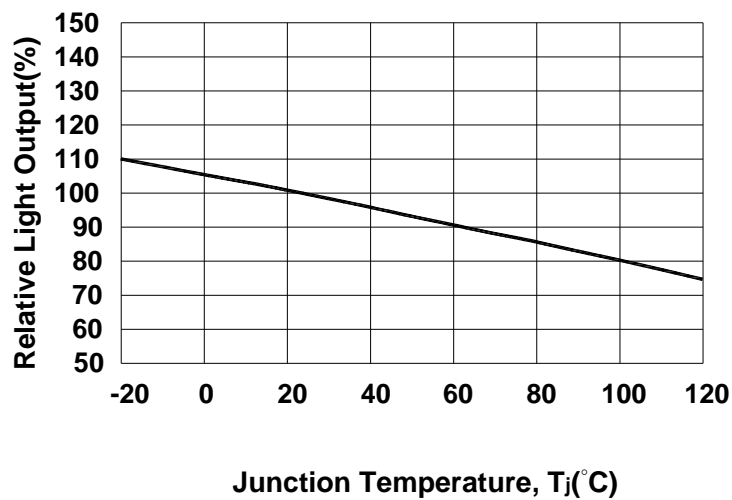

Figure 5. Relative Spectral Power Distribution vs. Wavelength

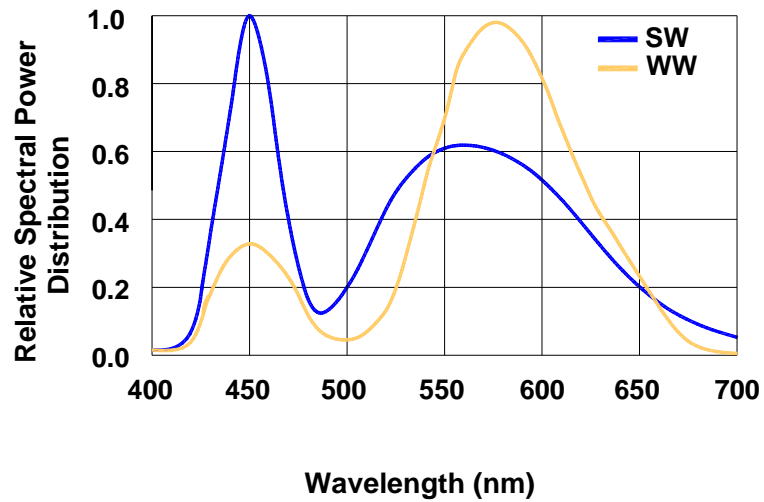
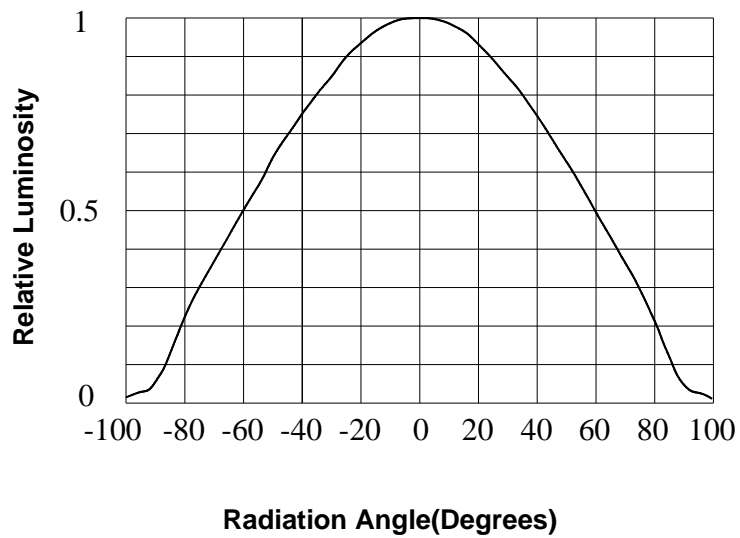
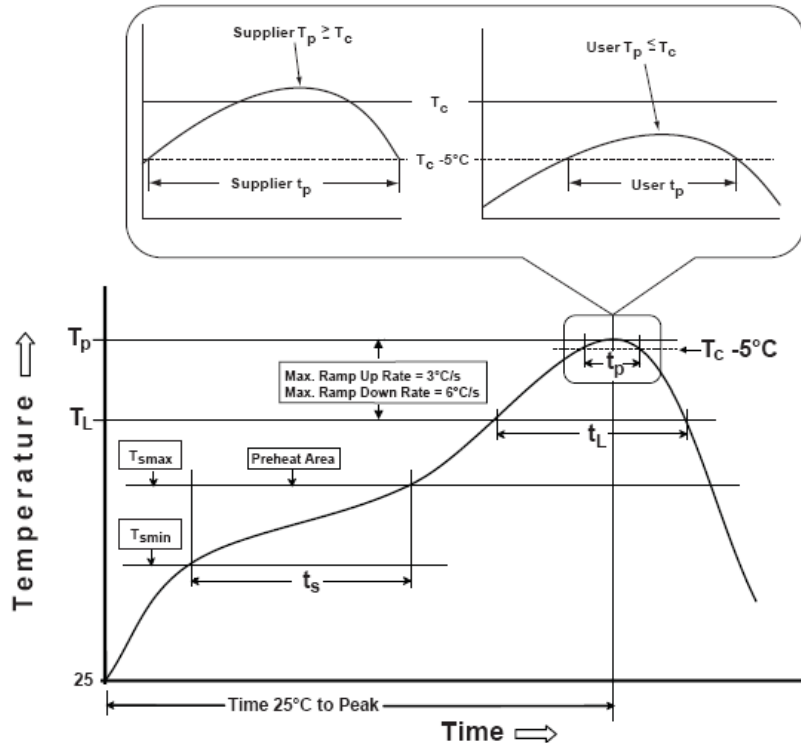

Figure 6. Relative Luminosity vs. Radiation Angle



■ Reflow Soldering Characteristics –



Profile Feature	Sn-Pb Eutectic Assembly	Pb-Free Assembly
Preheat & Soak		
Temperature Min (T_{smin})	100°C	150°C
Temperature Max (T_{smax})	150°C	200°C
Time (t_s) from (T_{smin} to T_{smax})	60-120 seconds	60-120 seconds
Ramp-up rate (T_L to T_p)	3°C/second max.	3°C/second max.
Liquidous temperature (T_L)	183°C	217°C
Time (t_L) maintained above T_L	60-150 seconds	60-150 seconds
Peak package body temperature (T_p)	For users T_p must not exceed the Classification temp in Table 4-1. For suppliers T_p must equal or exceed the Classification temp in Table 4-1.	For users T_p must not exceed the Classification temp in Table 4-2. For suppliers T_p must equal or exceed the Classification temp in Table 4-2.
Time (t_p)* within 5°C of the specified classification temperature (T_c), see Figure 5-1.	20* seconds	30* seconds
Ramp-down rate (T_p to T_L)	6°C/second max.	6°C/second max.
Time 25°C to peak temperature	6 minutes max.	8 minutes max.
*Tolerance for peak profile temperature (T_p) is defined as a supplier minimum and a user maximum		

■ Hand Soldering Characteristics –

Soldering temperature	260°C
Soldering time	5 sec

Notes : All temperatures refer to solder Pad

Spec. No.	PS-0905-001
Rev.	A

■ **Package –**

1. Tube : 50pcs/tube

CSC P/N : CSC Production number
 Flux : Intensity grade
 Color : Color grade
 Q'ty : Quantity

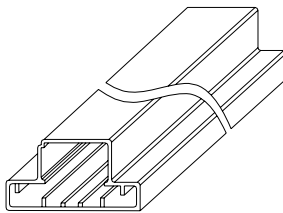



Part No :
Flux : Color: VF: Q'ty: pcs

on tube

2. Anti-electrostatic bag : 10 tubes/bag

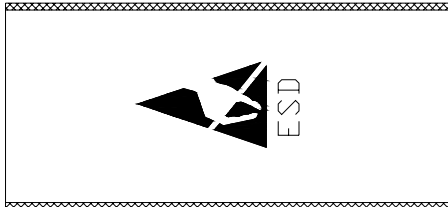
Product type : Vega Power
 CSC P/N : CSC Production number
 Flux : Intensity grade
 Color : Color grade
 Lot No : Lot Number
 Date code : Production time
 Q'ty : Quantity





Product Type :	Part No :
Flux : Color: VF: Q'ty: PCS	RoHS
Lot No : Date code :	QC :
	

on anti-electrostatic bag

3. Carton: 2 anti-electrostatic bags/carton

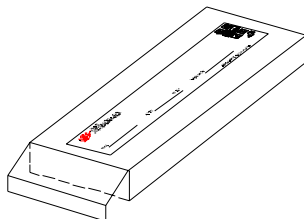
CSC P/N : CSC Production number
 Q'ty : Quantity
 Date code : Production time



 <p>CSC OPTOELECTRONICS A DIVISION OF CHINA SEMICONDUCTOR CORP</p>		
	P / N _____ Q'TY _____ PCS _____	Data code _____
SIZE:49.5X9.5X4.5cm		

on carton

■ **Precautions for use –**

1 . Please use LEDES refer to JEDEC 2a(Industry Best Moisture Sensitivity Level) as below

Floor life		Standard		Accelerated Environment	
time	conditions	time	conditions	time	conditions
4	≤ 30°C/60%RH	(hours)	30°C/60%RH	(hours)	60°C/60%RH
weeks		696 ² +5/-0		120+1/-0	

Notes : The standard soak time includes a default value of 24 hours for semiconductor exposure time between bake and bag and includes the maximum time allowed out of bag at the distributor's facility.

- 2 . Please confirm the moisture card in the anti-electrostatic bag after opening package.
If it shows 50%RH, LEDs should be performed baking treatment before used.
(bake condition: At 125°C +5/-0 for 24 hours)
- 3 . Any mechanical force or any excess vibration on LENS should be avoid during operating.
- 4 . LED should be stored below 60%RH after opening package.
- 5 . Please refer to Fig.3 of Page 10 to choose current drive to use. Ambient temperature will affect current.

Notes : The specifications are subject to change without notice. Please contact us for updated information.