

# DELPHI SERIES



## FEATURES

- ♦ High efficiency:  
92.5% @ 12Vin, 3.3V/50A out
- ♦ Size: 61.0x31.8x10.2mm  
(2.40"x1.25"x0.40")
- ♦ Voltage and resistor-based trim
- ♦ No minimum load required
- ♦ Output voltage programmable from 0.9Vdc to 3.63Vdc via external resistors
- ♦ Fixed frequency operation
- ♦ Single-in line package (SIP)
- ♦ Input UVLO, output OCP, OTP, SCP
- ♦ Remote ON/OFF (Positive)
- ♦ Power good output signal (open collector)
- ♦ Output voltage sense
- ♦ ISO 9001, TL 9000, ISO 14001, QS9000, OHSAS18001 certified manufacturing facility
- ♦ UL/cUL 60950-1 (US & Canada), TUV (EN60950-1) - pending

## Delphi ND Series Non-Isolated Point of Load DC/DC Power Modules: 12Vin, 0.9V~3.63Vout, 50Aout

The Delphi ND Series, 12V input, single output, non-isolated point of load (POL) DC/DC converters are the latest offering from a world leader in power systems technology and manufacturing — Delta Electronics, Inc. The ND/NE product family is the second generation, non-isolated point-of-load DC/DC power modules for the DataCom / Networking / IT Applications and it will help to cut the module size by 35% to 50% compared to the first generation NC series POL modules. The ND/NE product family provides 6A to 60A of output current in a vertically or horizontally mounted through-hole package and the output can be resistor trimmed from 0.9Vdc to 3.63Vdc. It provides a very cost effective, high efficiency, and high density point of load solution. With creative design technology and optimization of component placement, these converters possess outstanding electrical and thermal performance, as well as extremely high reliability under highly stressful operating conditions.

## OPTION

- ♦ Negative on/off logic
- ♦ Current sharing

## APPLICATIONS

- ♦ DataCom
- ♦ Distributed power architectures
- ♦ Servers and workstations
- ♦ LAN / WAN applications
- ♦ Data processing applications

PRELIMINARY DATASHEET  
DS\_ND12S50A\_07172008

  
Delta Electronics, Inc.

# TECHNICAL SPECIFICATIONS

(Ambient Temperature=25°C, minimum airflow=200LFM, nominal  $V_{in}$ =12Vdc unless otherwise specified.)

PARAMETER	NOTES and CONDITIONS	ND12S0A0V50 (Standard)			
		Min.	Typ.	Max.	Units
<b>ABSOLUTE MAXIMUM RATINGS</b>					
Input Voltage		-0.3		13.8	Vdc
Operating Temperature	Refer to Figure 32 for the measuring point	0		124	°C
Storage Temperature		-40		125	°C
Input/Output Isolation Voltage	Non-isolated		NA		V
<b>INPUT CHARACTERISTICS</b>					
Operating Input Voltage		10.2	12.0	13.8	V
Input Under-Voltage Lockout					
Turn-On Voltage Threshold		8.5	9.0	9.5	V
Turn-Off Voltage Threshold		7.1	7.6	8.1	V
Lockout Hysteresis Voltage			1.4		V
Maximum Input Current	100% Load, 10.2Vin, 3.3Vout			24	A
No-Load Input Current	Vin=12V, Vout=3.3V			250	mA
Off Converter Input Current	Remote OFF		15	30	mA
Inrush Transient	Vin=10.2~13.8V, Io=Min to Max Load			1.00	A <sup>2</sup> S
Input Reflected-Ripple Current	Refer to Figure 31.		20		mA
Input Ripple Rejection	120Hz		60		dB
<b>OUTPUT CHARACTERISTICS</b>					
Output Voltage Adjustment Range		0.9		3.63	V
Output Voltage Set Point	With a 1.0% trim resistor	-2		+2	%
Output Voltage Regulation					
Over Load	Io=Io_min to Io_max	-1		+1	%
Over Line	Vin=Vin_min to Vin_max	-0.2		+0.2	%
Total output range	Over load, line, temperature regulation and set point	-3		+3	%
Output Voltage Ripple and Noise	5Hz to 20MHz bandwidth				
Peak-to-Peak	Full Load, 1uF ceramic, 10uF Tan cap and 4*680uF OSCON		25	50	mV
RMS	Full Load, 1uF ceramic, 10uF Tan cap and 4*680uF OSCON		5	15	mV
Output Current Range		0		50	A
Output Voltage Over-shoot at Start-up	Vin=12V, Turn ON			2	%
Output Voltage Under-shoot at Power-Off	Vin=12V, Turn OFF			100	mV
Output DC Current-Limit Inception	Hiccup mode	110		200	%Iomax
<b>DYNAMIC CHARACTERISTICS</b>					
Output Dynamic Load Response	12Vin, 1uF ceramic, 10uF Tan cap and 4*680uF OSCON				
Positive Step Change in Output Current	25A to 37.5A, 10A/uS		75		mV
Negative Step Change in Output Current	37.5A to 25A, 10A/uS		75		mV
Settling Time	Settling to be within regulation band (to 10% Vo deviation)		50		µs
Turn-On Transient					
Start-Up Time, from On/Off Control	From Enable high to 90% of Vo			10	ms
Start-Up Time, from input power	From Vin=12V to 90% of Vo			10	ms
Minimum Output Capacitance	Ex: One OSCON 6.3V/680uF (ESR=13mΩ max)	680			µF
Maximum Output Startup Capacitive Load	Full Load (ESR ≥ 1mΩ)			3000	µF
Minimum Input Capacitance		0			µF
<b>EFFICIENCY</b>					
Vo=0.9V	Vin=12V, Io=50A		81		%
Vo=1.2V	Vin=12V, Io=50A		84.5		%
Vo=1.5V	Vin=12V, Io=50A		87		%
Vo=1.8V	Vin=12V, Io=50A		88.5		%
Vo=2.5V	Vin=12V, Io=50A		91		%
Vo=3.3V	Vin=12V, Io=50A		92.5		%
Vo=3.63V	Vin=12V, Io=50A		92.8		%
<b>FEATURE CHARACTERISTICS</b>					
Switching Frequency	Fixed		300		KHz
ON/OFF Control	Positive logic (internally pulled high)				
Logic High	Module On (or leave the pin open)	2.4		Vinmax	V
Logic Low	Module Off	-0.2		0.8	V
Remote Sense Range				0.5	V
<b>GENERAL SPECIFICATIONS</b>					
Calculated MTBF	Telcordia SR-332 Issue1 Method1 Case3 at 50°C		TBD		Mhours
Weight			34.2		grams
Over-Temperature Shutdown	Refer to Figure 32 for the measuring point		134		°C



# ELECTRICAL CHARACTERISTICS CURVES

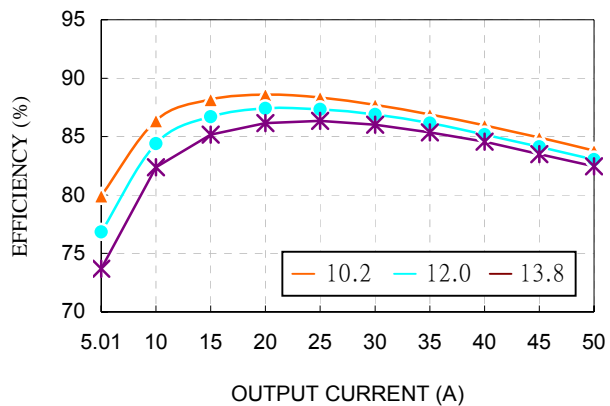

Figure 1: Converter efficiency vs. output current (0.9V output voltage)

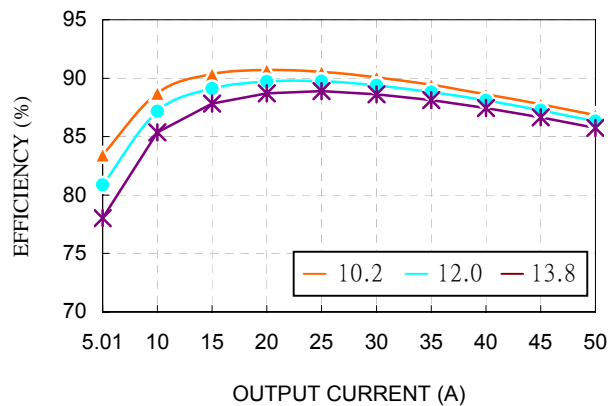

Figure 2: Converter efficiency vs. output current (1.2V output voltage)

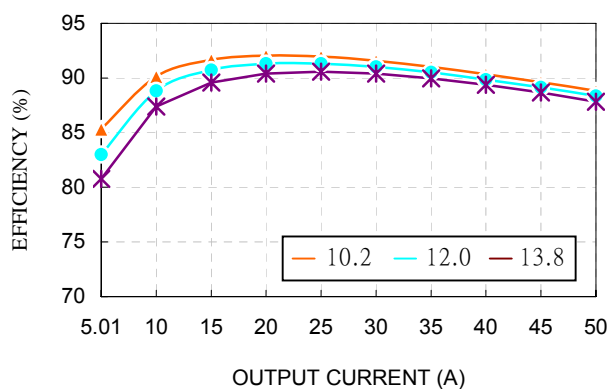

Figure 3: Converter efficiency vs. output current (1.5V output voltage)

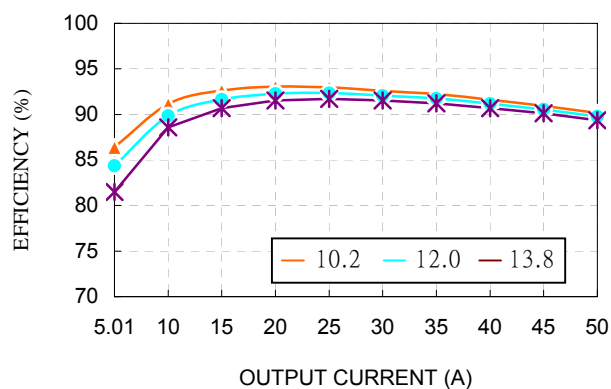

Figure 4: Converter efficiency vs. output current (1.8V output voltage)

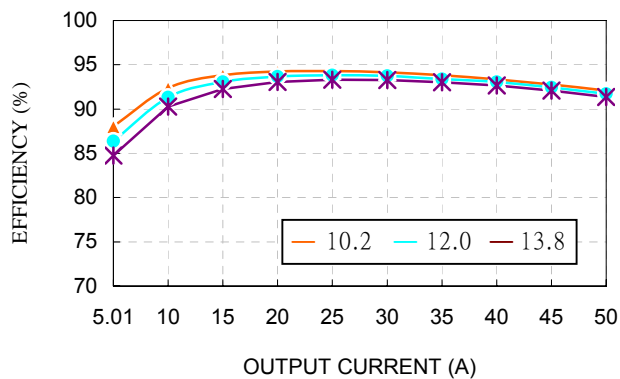

Figure 5: Converter efficiency vs. output current (2.5V output voltage)

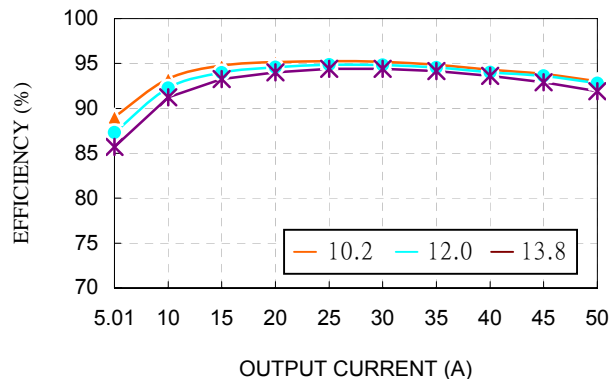

Figure 6: Converter efficiency vs. output current (3.3V output voltage)



# ELECTRICAL CHARACTERISTICS CURVES (CON.)

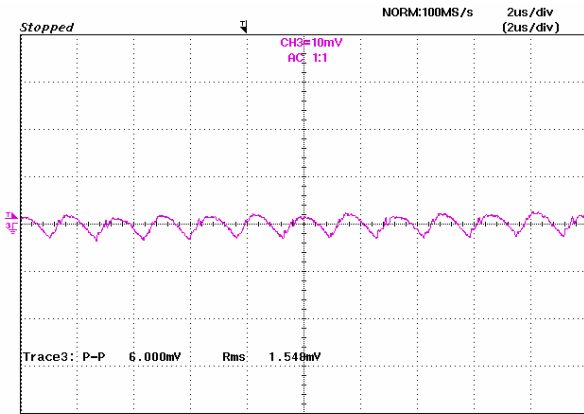

Figure 7: Output ripple & noise at 12Vin, 0.9V/50A out

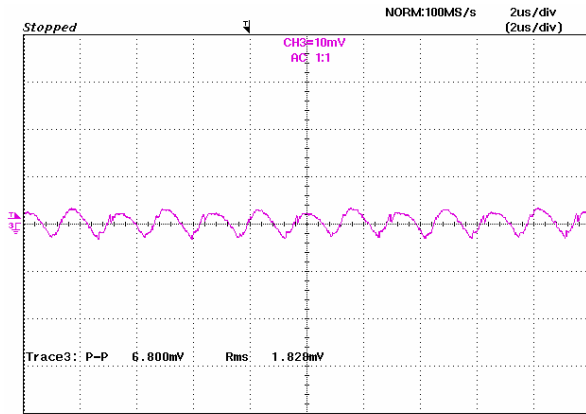

Figure 8: Output ripple & noise at 12Vin, 1.2V/50A out

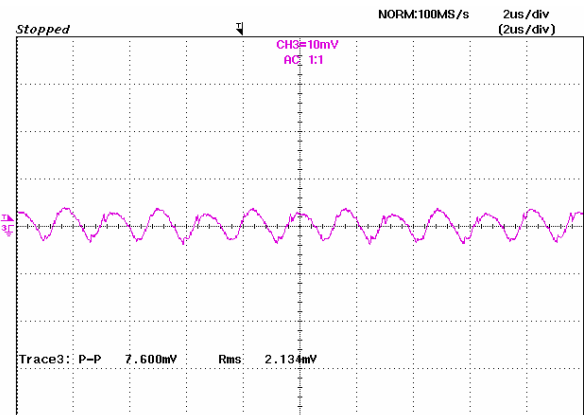

Figure 9: Output ripple & noise at 12Vin, 1.5V/50A out

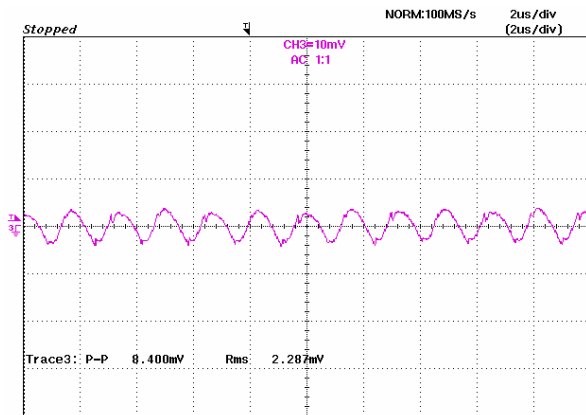

Figure 10: Output ripple & noise at 12Vin, 1.8V/50A out

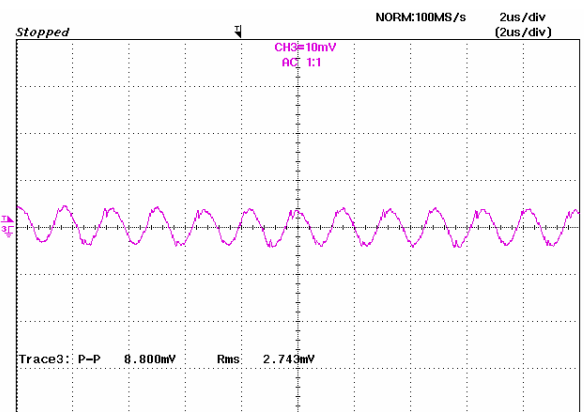

Figure 11: Output ripple & noise at 12Vin, 2.5V/50A out

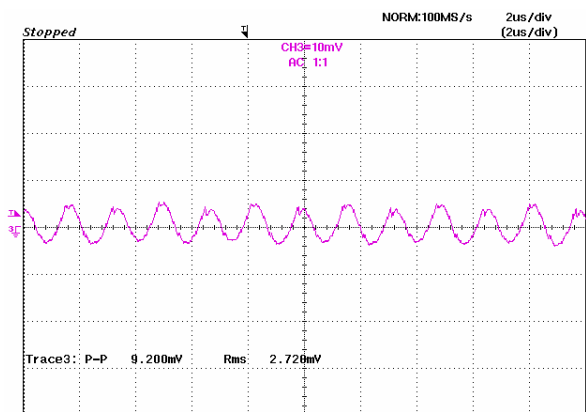
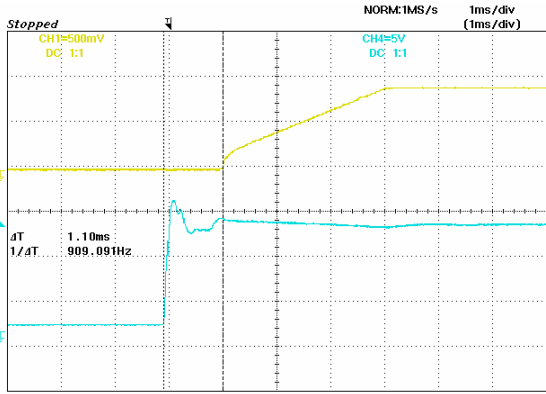

Figure 12: Output ripple & noise at 12Vin, 3.3V/50A out



# ELECTRICAL CHARACTERISTICS CURVES (CON.)



**Figure 13:** Turn on delay time at 12Vin, 0.9V/50A out  
Ch1: Vout Ch4: Vin

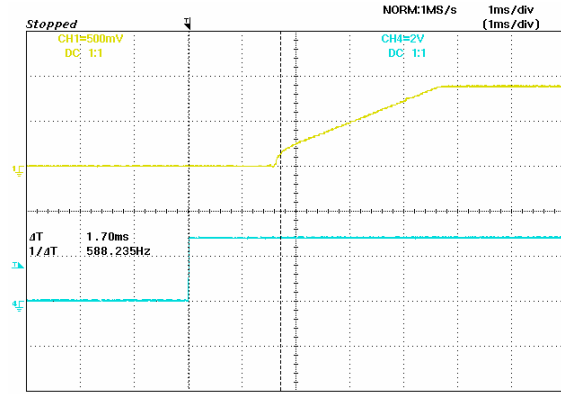

**Figure 14:** Turn on delay time Remote On/Off, 0.9V/50A out  
Ch1: Vout Ch4: Enable

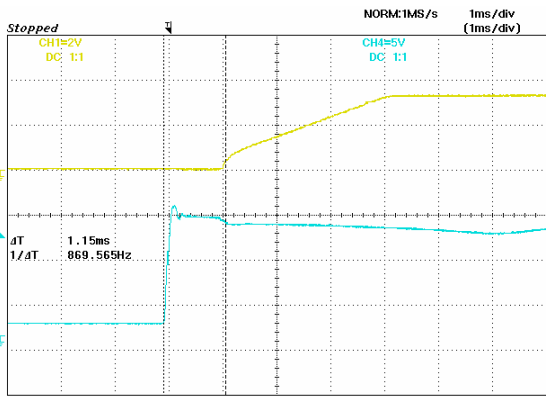

**Figure 15:** Turn on delay time at 12Vin, 3.3V/50A out  
Ch1: Vout Ch4: Vin

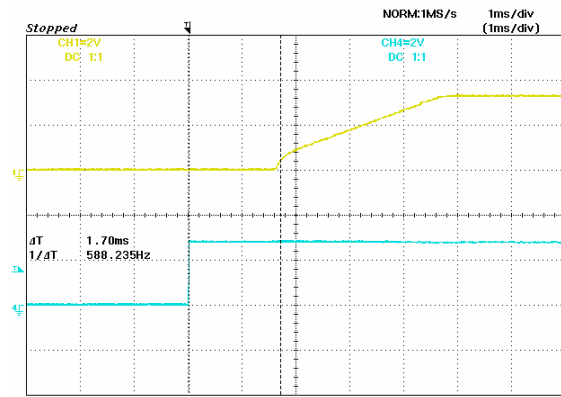

**Figure 16:** Turn on delay time at Remote On/Off, 3.3V/50A out  
Ch1: Vout Ch4: Enable

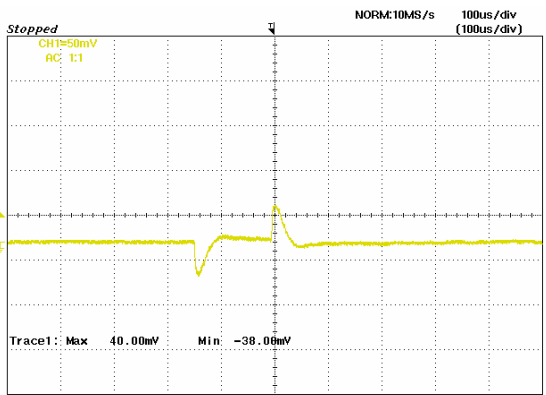

**Figure 17:** Typical transient response to step load change at 10A/μS from 50% to 75% and 75% to 50 of Io, max at 12Vin, 0.9V out

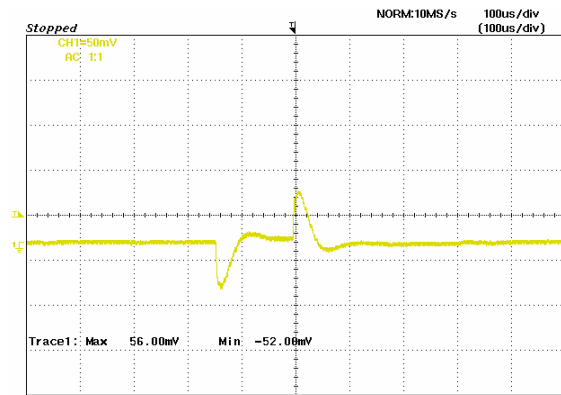

**Figure 18:** Typical transient response to step load change at 10A/μS from 50% to 75% and 75% to 50 of Io, max at 12Vin, 1.2V out

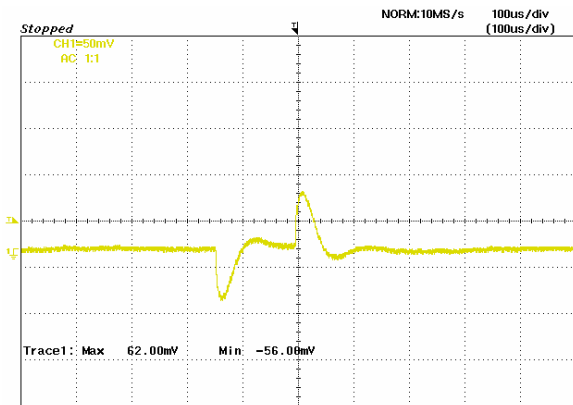

**Figure 19:** Typical transient response to step load change at  $10A/\mu S$  from 50% to 75% and 75% to 50 of  $I_o$ , max at 12Vin, 1.5V out

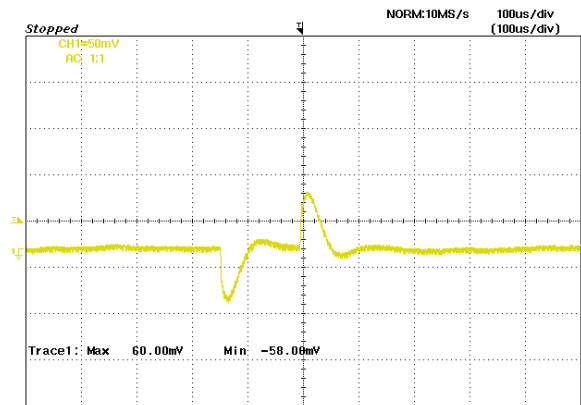

**Figure 20:** Typical transient response to step load change at  $10A/\mu S$  from 50% to 75% and 75% to 50 of  $I_o$ , max at 12Vin, 1.8V out

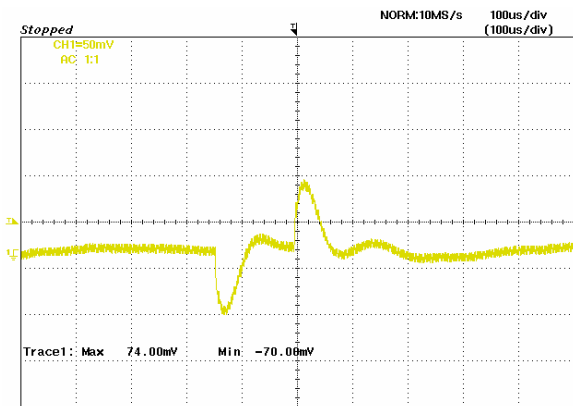

**Figure 21:** Typical transient response to step load change at  $10A/\mu S$  from 50% to 75% and 75% to 50 of  $I_o$ , max at 12Vin, 2.5V out

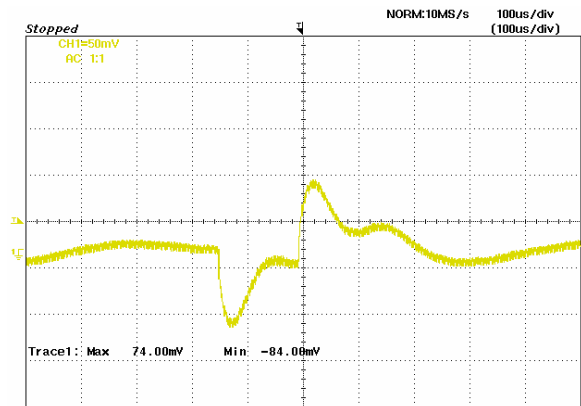

**Figure 22:** Typical transient response to step load change at  $10A/\mu S$  from 50% to 75% and 75% to 50 of  $I_o$ , max at 12Vin, 3.3V out

## DESIGN CONSIDERATIONS

The ND 50A uses two phase and voltage mode controlled buck topology. The output can be trimmed in the range of 0.9Vdc to 3.63Vdc with a resistor from Trim pin to Ground. A remote sense function is provided and it is able to compensate for a drop from the output of converter to point of load.

The converter can be turned ON/OFF by remote control. Positive on/off (ENABLE pin) logic implies that the converter DC output is enabled when the signal is driven high (greater than 2.4V) or floating and disabled when the signal is driven low (below 0.8V). Negative on/off logic is optional.

The converter provides an open collector Power Good signal. The power good signal is pulled low when output is not within  $\pm 10\%$  of  $V_{out}$  or Enable is OFF.

The converter can protect itself by entering hiccup mode against over current and short circuit condition.

The converter has an over temperature protection which can protect itself by shutting down for an over temperature event. There is a thermal hysteresis of typically 20°C

### Safety Considerations

It is recommended that the user to provide a fuse with **TBD** in the input line for safety. The output voltage set-point and the output current in the application could define the amperage rating of the fuse.

## FEATURES DESCRIPTIONS

### ENABLE (On/Off)

The ENABLE (on/off) input allows external circuitry to put the ND converter into a low power dissipation (sleep) mode. Positive ENABLE is available as standard.

Positive ENABLE units of the ND series are turned on if the ENABLE pin is high or floating. Pulling the pin low will turn off the unit. With the active high function, the output is guaranteed to turn on if the ENABLE pin is driven above 2.4V. The output will turn off if the ENABLE pin voltage is pulled below 0.8V.

The ENABLE input can be driven in a variety of ways as shown in Figures 23 and 24. If the ENABLE signal comes from the primary side of the circuit, the ENABLE can be driven through either a bipolar signal transistor (Figure 23). If the enable signal comes from the secondary side, then an opto-coupler or other isolation devices must be used to bring the signal across the voltage isolation (please see Figure 24).

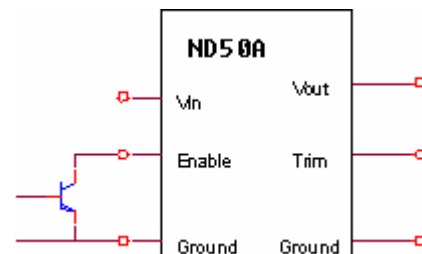

Figure 23: Enable Input drive circuit for ND series

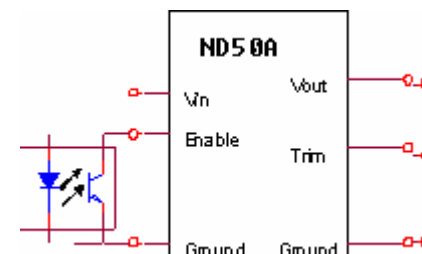

Figure 24: Enable input drive circuit example with isolation.

## FEATURES DESCRIPTIONS (CON.)

### Input Under-Voltage Lockout

The input under-voltage lockout prevents the converter from being damaged while operating when the input voltage is too low. The lockout occurs between 7.6V to 9.0V.

### Over-Current and Short-Circuit Protection

The ND series modules have non-latching over-current and short-circuit protection circuitry. When over current condition occurs, the module goes into the non-latching hiccup mode. When the over-current condition is removed, the module will resume normal operation.

An over current condition is detected by measuring the voltage drop across the MOSFETs. The voltage drop across the MOSFET is also a function of the MOSFET's  $R_{ds(on)}$ .  $R_{ds(on)}$  is affected by temperature, therefore ambient temperature will affect the current limit inception point.

The detection of the  $R_{ds(on)}$  of MOSFETs also acts as an over temperature protection since high temperature will cause the  $R_{ds(on)}$  of the MOSFETs to increase, eventually triggering over-current protection.

### Remote sense

The ND50 provide  $V_o$  remote sensing to achieve proper regulation at the load points and reduce effects of distribution losses on output line. In the event of an open remote sense line, the module shall maintain local sense regulation through an internal resistor. The module shall correct for a total of 0.5V of loss. The remote sense connects as shown in Figures 25.

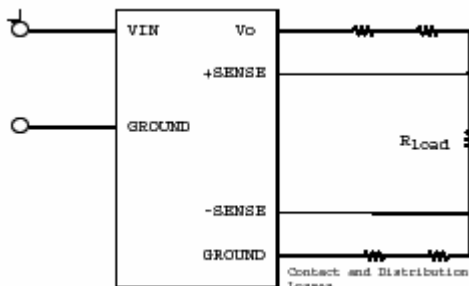

Figure 25: circuit configuration for remote sense

### Over Temperature Protection (OTP)

To provide additional over-temperature protection in a fault condition, the unit is equipped with a non-latching thermal shutdown circuit. The shutdown circuit engages when the temperature of monitored component exceeds approximately 125°C. The unit will cycle on and off while the fault condition exists. The unit will recover from shutdown when the cause of the over temperature condition is removed.

### Output Voltage Programming

The output voltage of the ND series is trimmable by connecting an external resistor between the trim pin and output ground as shown Figure 26 and the typical trim resistor values are shown in Figure 27.

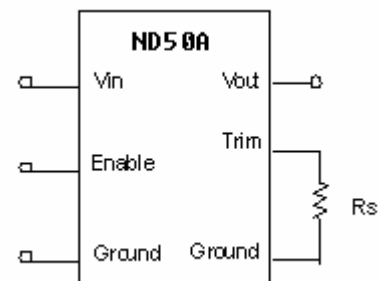

Figure 26: Trimming Output Voltage

The ND50 module has a trim range of 0.9V to 3.63V. The trim resistor equation for the ND50A is:

$$R_s (\text{k}\Omega) = \frac{12.69 - V_{out}}{V_{out} - 0.9}$$

$V_{out}$  is the output voltage setpoint

$R_s$  is the resistance between Trim and Ground

$R_s$  values should not be less than 3.32k $\Omega$

Output Voltage	$R_s$ ( $\Omega$ )
0.9V	open
+1.2 V	38.3k
+1.5 V	18.7k
+1.8V	12.1k
+2.5 V	6.34k
+3.3V	3.92k
+3.63V	3.32k

Figure 27: Typical trim resistor values



## FEATURES DESCRIPTIONS (CON.)

The output can also be set by an external voltage connected to trim pin as shown in Figure 28

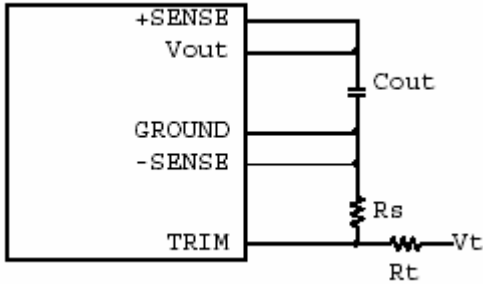

**Figure 28:** output voltage trim with voltage source

To use voltage trim, the trim equation for the ND50 is (please refer to Fig.28):

$$R_t(k\Omega) = \frac{R_s(13.1V_t + V_{out} - 12.69)}{0.9R_s - V_{out}(R_s + 1) + 12.69}$$

Vout is the desired output voltage

Vt is the external trim voltage

Rs is the resistance between Trim and Ground (in KΩ)

Rt is the resistor to be defined with the trim voltage (in KΩ)

Below is an example about using this voltage trim equation:

Example:

If Vt=1.25V, desired Vout=2.5V and Rs=1kΩ

$$R_t(k\Omega) = \frac{R_s(13.1V_t + V_{out} - 12.69)}{0.9R_s - V_{out}(R_s + 1) + 12.69} = 0.72k\Omega$$

## Power Good

The converter provides an open collector signal called Power Good. This output pin uses positive logic and is open collector. This power good output is able to sink 5mA and set high when the output is within ±10% of output set point. The power good signal is pulled low when output is not within ±10% of Vout or Enable is OFF.

## Output Capacitance

an external output capacitor(min 680uF) is required for stable operation.

## Voltage Margining Adjustment

Output voltage margin adjusting can be implemented in the ND modules by connecting a resistor, Rmargin-up, from the Trim pin to the Ground for margining up the output voltage. Also, the output voltage can be adjusted lower by connecting a resistor, Rmargin-down, from the Trim pin to the voltage source Vt. Figure 29 shows the circuit configuration for output voltage margining adjustment.

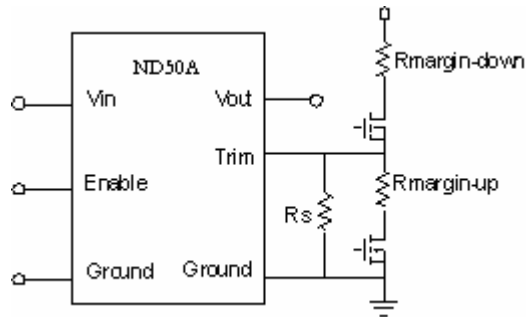

**Figure 29:** Circuit configuration for output voltage margining

## Reflected Ripple Current and Output Ripple and Noise Measurement

The measurement set-up outlined in Figure 30 has been used for both input reflected/ terminal ripple current and output voltage ripple and noise measurements on ND series converters.

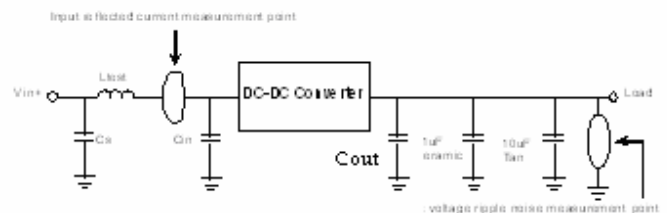

Cs=270μF\*1, Ltest=1.4uH, Cin=270μF\*2. Cout=680uF\*4

**Figure 30:** Input reflected ripple/ capacitor ripple current and output voltage ripple and noise measurement setup for ND50



## THERMAL CONSIDERATION

Thermal management is an important part of the system design. To ensure proper, reliable operation, sufficient cooling of the power module is needed over the entire temperature range of the module. Convection cooling is usually the dominant mode of heat transfer.

Hence, the choice of equipment to characterize the thermal performance of the power module is a wind tunnel.

### Thermal Testing Setup

Delta's DC/DC power modules are characterized in heated vertical wind tunnels that simulate the thermal environments encountered in most electronics equipment. This type of equipment commonly uses vertically mounted circuit cards in cabinet racks in which the power modules are mounted.

The following figure shows the wind tunnel characterization setup. The power module is mounted on a test PWB and is vertically positioned within the wind tunnel. The space between the neighboring PWB and the top of the power module is constantly kept at 6.35mm (0.25").

### Thermal Derating

Heat can be removed by increasing airflow over the module. To enhance system reliability, the power module should always be operated below the maximum operating temperature. If the temperature exceeds the maximum module temperature, reliability of the unit may be affected.

## THERMAL CUREVES

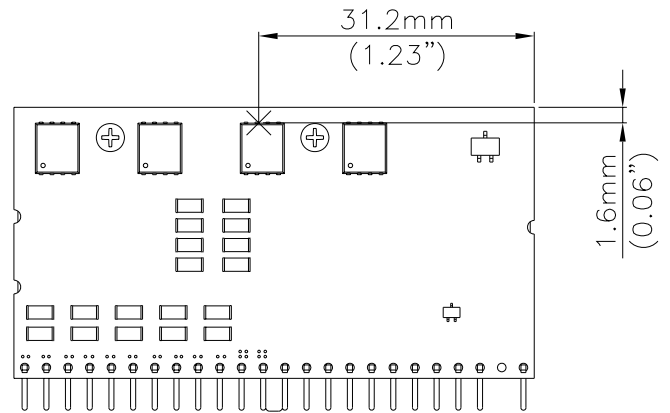

**Figure 32:** Temperature measurement location\* The allowed maximum hot spot temperature is defined at 124 °C

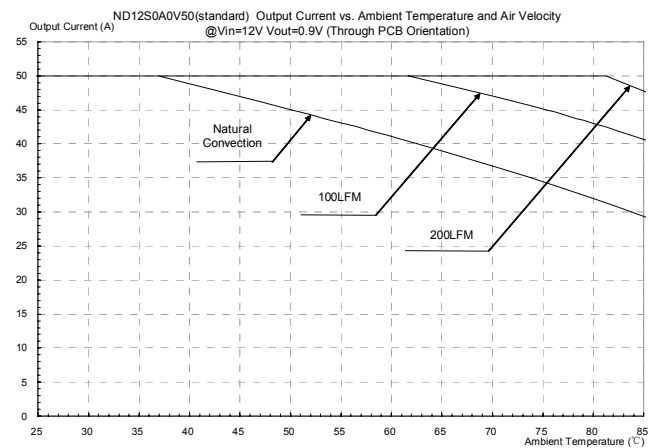

**Figure 33:** Output current vs. ambient temperature and air velocity @ Vin=12V, Vout=0.9V(Through PCB Orientation)

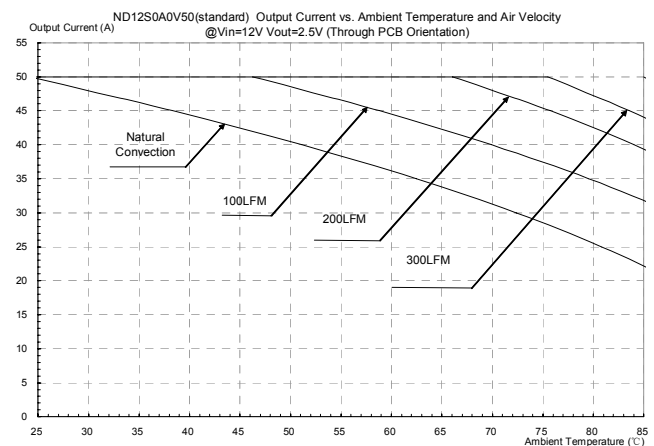

**Figure 34:** Output current vs. ambient temperature and air velocity @ Vin=12V, Vout=2.5V(Through PCB Orientation)

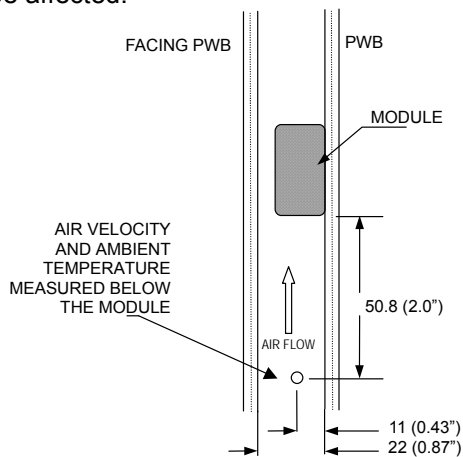

**Note:** Wind tunnel test setup figure dimensions are in millimeters and (Inches)

**Figure 31:** Wind tunnel test setup

# THERMAL CUREVES

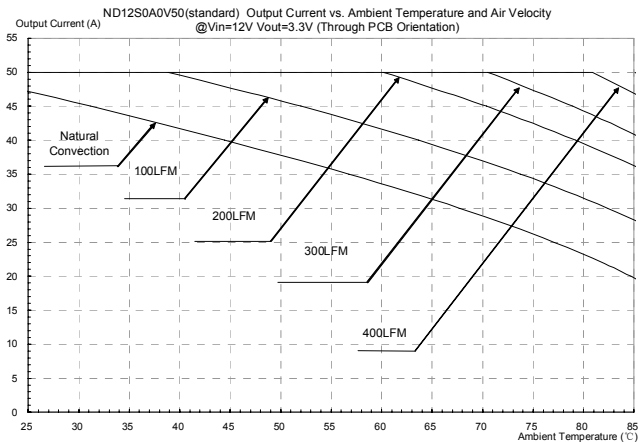
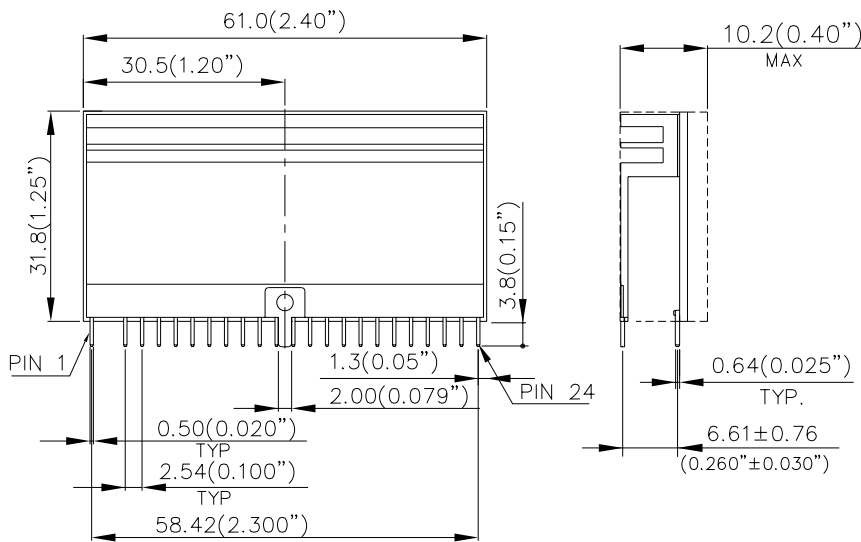

Figure 35: Output current vs. ambient temperature and air velocity @ Vin=12V, Vout=3.3V(Through PCB Orientation)

# MECHANICAL DRAWING

## VERTICAL



PIN ASSIGNMENT	
PIN#	FUNCTION
1	TRIM
2	KEY
3	GND
4	PGooD
5	NC
6	Share
7	GND
8	GND
9	On/Off
10	-SENSE
11	+SENSE
12	VIN
13	VIN
14	VIN
15	VO
16	VO
17	GND
18	VO
19	GND
20	VO
21	GND
22	VO
23	GND
24	VO

NOTES:  
 DIMENSIONS ARE IN MILLIMETERS AND (INCHS)  
 TOLERANCE: X.X mm ± 0.5 mm (X.XX in. ± 0.02 in.)  
 X.XX mm ± 0.25 mm (X.XXX in. ± 0.010 in.)

## PART NUMBERING SYSTEM

ND	12	S	0A0	V	50	P	N	F	A
Product Series	Input Voltage	Number of outputs	Output Voltage	Mounting	Output Current	ON/OFF Logic	Pin Length		Option Code
ND-Non-isolated Series	12- 10.2~13.8V	S- Single Output	0A0 - Programmable	V- Vertical	50-50A	P- Positive N- Negative	N- 0.150"	F- RoHS 6/6 (Lead Free)	A- Standard Functions

## MODEL LIST

Model Name	Packaging	Input Voltage	Output Voltage	Output Current	Efficiency 12Vin @ 100% load
ND12S0A0V50PNFA	Vertical	10.2 ~ 13.8Vdc	0.9 V ~ 3.63Vdc	50A	92.5%

### CONTACT: [www.delta.com.tw/dcdc](http://www.delta.com.tw/dcdc)

#### USA:

Telephone:  
East Coast: (888) 335 8201  
West Coast: (888) 335 8208  
Fax: (978) 656 3964  
Email: [DCDC@delta-corp.com](mailto:DCDC@delta-corp.com)

#### Europe:

Telephone: +41 31 998 53 11  
Fax: +41 31 998 53 53  
Email: [DCDC@delta-es.tw](mailto:DCDC@delta-es.tw)

#### Asia & the rest of world:

Telephone: +886 3 4526107 ext. 6220  
Fax: +886 3 4513485  
Email: [DCDC@delta.com.tw](mailto:DCDC@delta.com.tw)

## WARRANTY

Delta offers a two (2) year limited warranty. Complete warranty information is listed on our web site or is available upon request from Delta.

Information furnished by Delta is believed to be accurate and reliable. However, no responsibility is assumed by Delta for its use, nor for any infringements of patents or other rights of third parties, which may result from its use. No license is granted by implication or otherwise under any patent or patent rights of Delta. Delta reserves the right to revise these specifications at any time, without notice.