

Ethernet DC/DC Converter EPC1107, EPC1107P & EPC1107H

- Features**
- 70 % Typical efficiency at full load @ nominal input voltage
 - Regulated Output
 - Input filter to reduce input ripple current
 - Designed for low common mode noise

Electrical Specifications

Note : *Package with G for Surface Mount Device

PCA P/N	Standard Package	Optional Packages	Input Voltage V	Output Voltage V	Output Current mA Max.	Output Ripple & Noise @ 20 MHz BW mV p-p	Isolation Vrms
EPC1107	E	E-G*, E1, E4, Q E1-G*, E4-G*, F2	6.0 ± 10%	12 ± 5%	150	100 Max.	N/A
EPC1107P	E	E-G*, E1, E4, Q E1-G*, E4-G*, F2	6.0 ± 10%	12 ± 5%	150	100 Max.	500
EPC1107H	E1	E1-G*, Q, N1	6.0 ± 10%	12 ± 5%	150	100 Max.	2000

Pin Connections for E

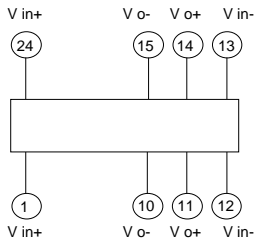

Pin Connections for E1

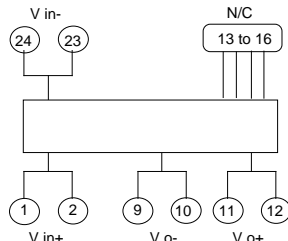

Pin Connections for F2

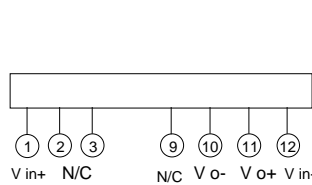

Pin Connections for Q

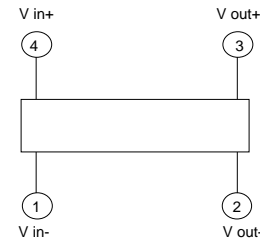

PACKAGE F2

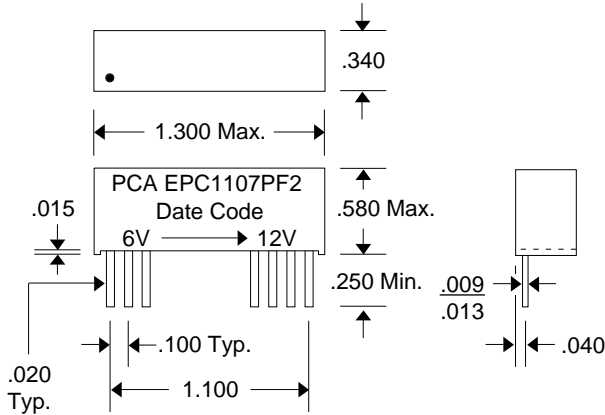

PACKAGE E

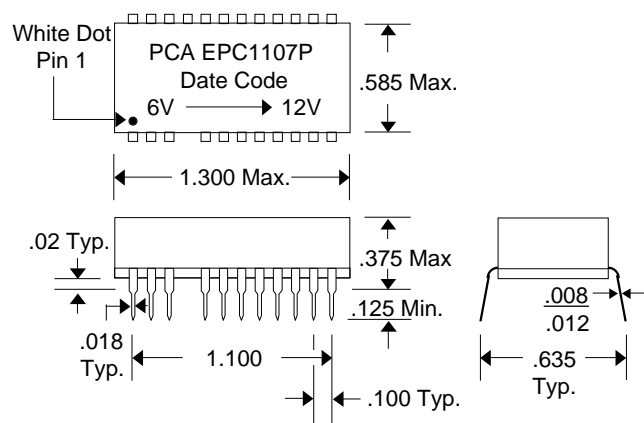

PACKAGE Q

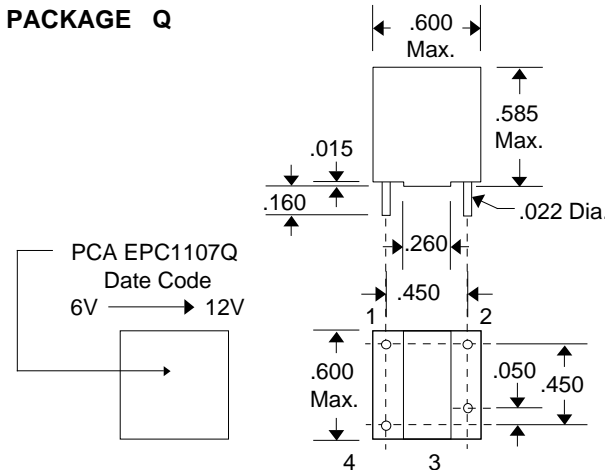

PACKAGE E1

