



LIGITEK

LIGITEK ELECTRONICS CO.,LTD.
Property of Ligitek Only

TAPE AND BOX TYPE LED LAMPS



Lead-Free Parts

LSRG2092/R6-PF/TBS-2

DATA SHEET

DOC. NO : QW0905-LSRG2092/R6-PF/TBS-2

REV. : A

DATE : 29 - Jan.- 2009





Package Dimensions

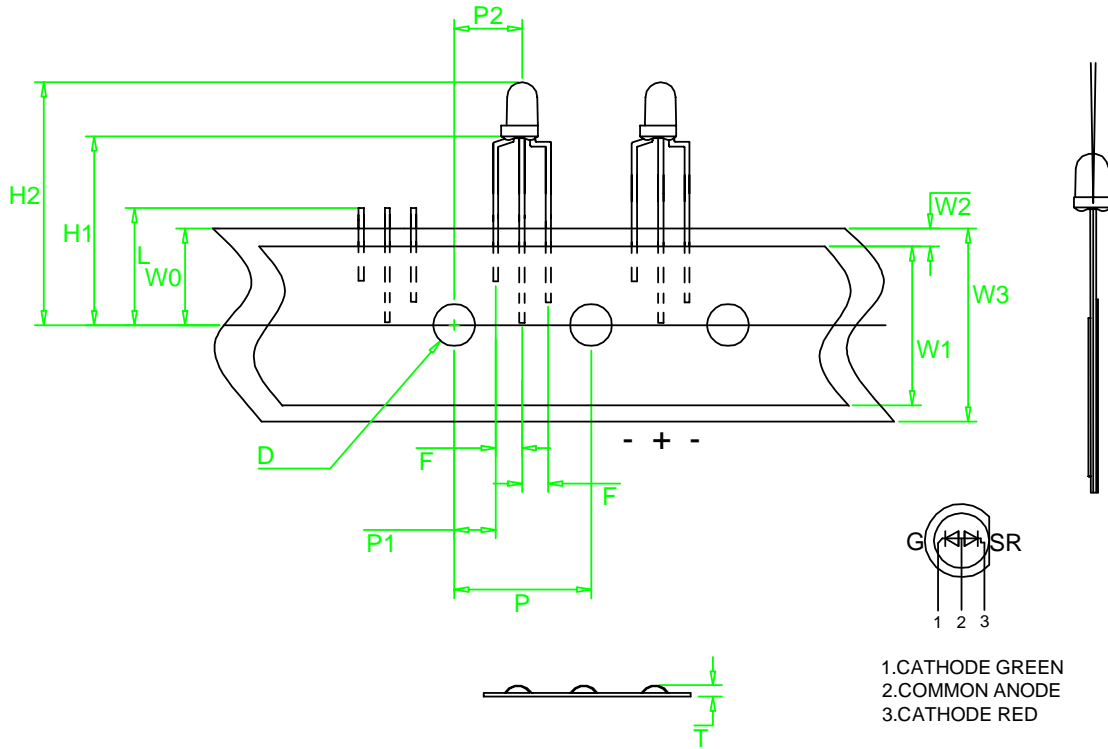

LSR2092/R6-PF

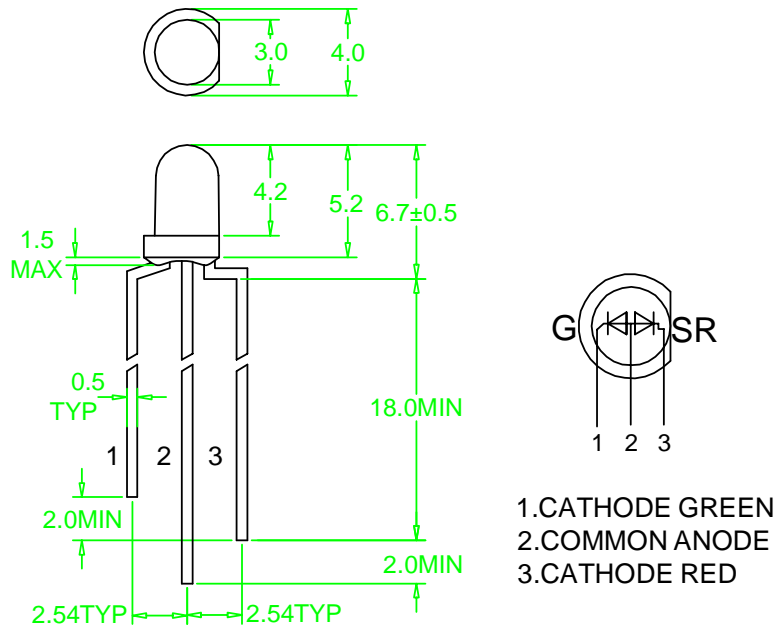

Note : 1.All dimension are in millimeter tolerance is $\pm 0.25\text{mm}$ unless otherwise noted.
2.Specifications are subject to change without notice.



Absolute Maximum Ratings at Ta=25

Parameter	Symbol	Ratings		UNIT
		SR	G	
Forward Current	IF	30	30	mA
Peak Forward Current Duty 1/10@10KHz	IFP	100	120	mA
Power Dissipation	PD	100	100	mW
Reverse Current @5V	Ir	10		μ A
Operating Temperature	Topr	-40 ~ +85		
Storage Temperature	Tstg	-40 ~ +100		

* Static Electricity or power surge will damage the LED. Use of a conductive wrist band or anti-electrostatic glove is recommended when handling these LED. All devices, equipment and machinery must be properly grounded.

Typical Electrical & Optical Characteristics (Ta=25)

PART NO	MATERIAL	COLOR		Peak wave length Pnm	Spectral halfwidth nm	Forward voltage @20mA(V)		Luminous intensity @20mA(mcd)		Viewing angle 2 1/2 (deg)
		Emitted	Lens			Min.	Max.	Min.	Typ.	
LSRG2092/R6-PF/TBS-2	GaAlAs	Red	White Diffused	660	20	1.5	2.4	28	65	70
	GaP	Green		565	30	1.7	2.6	21	50	70

Note : 1.The forward voltage data did not including ±0.1V testing tolerance.
2. The luminous intensity data did not including ±15% testing tolerance.



LIGITEK

LIGITEK ELECTRONICS CO.,LTD.
Property of Ligitek Only

PART NO.LSRG2092/R6-PF/TBS-2

Page 3/7

Dimensions Symbol Information

SYMBOL ITEMS	OPTION CODE	SYMBOL	SPECIFICATIONS			
			Minimum		Maximum	
			mm	inch	mm	inch
Tape Feed Hole Diameter	-----	D	3.8	0.15	4.2	0.17
Component Lead Pitch	-----	F	2.3	0.09	3.0	0.12
Front-To-Rear Deflection	-----	H	-----	-----	2.0	0.08
Feed Hole To Bottom Of Component	TBS-2	H1	21.5	0.85	22.5	0.89
	-----		-----	-----	-----	
	-----		-----	-----	-----	
	-----		-----	-----	-----	
	-----		-----	-----	-----	
	-----		-----	-----	-----	
	-----		-----	-----	-----	
	-----		-----	-----	-----	
Feed Hole To Overall Component Height	-----	H2	-----	-----	36	1.42
Lead Length After Component Height	-----	L	W0		11.0	0.43
Feed Hole Pitch	-----	P	12.4	0.49	13.0	0.51
Lead Location	-----	P1	4.4	0.17	5.8	0.23
Center Of Component Location	-----	P2	5.1	0.2	7.7	0.3
Overall Taped Package Thickness	-----	T	-----	-----	1.42	0.06
Feed Hole Location	-----	W0	8.5	0.33	9.75	0.38
Adhesive Tape Width	-----	W1	14.5	0.57	15.5	0.61
Adhesive Tape Position	-----	W2	0	0	4.0	0.16
Tape Width	-----	W3	17.5	0.69	19.0	0.75

REMARK:TBS=Tape And Box Straight Leads

Dimensions Symbol Information

Package Dimensions

Description	Symbol	Specification			
		minimum		maximum	
		mm	inch	mm	inch
Overall Length	L	330	13.0	340	13.4
Overall Width	W	265	10.4	275	10.8
Overall Thickness	H	50	1.97	60	2.4
Quantity/Box	2500PCS				

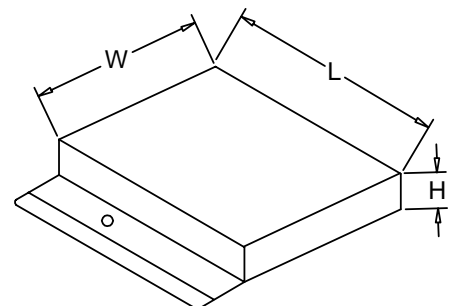



Typical Electro-Optical Characteristics Curve

SR CHIP

Fig.1 Forward current vs. Forward Voltage

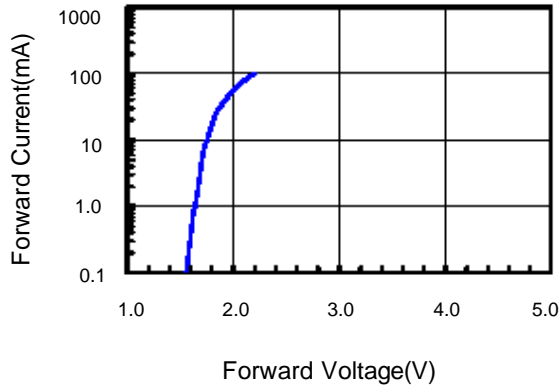

Fig.2 Relative Intensity vs. Forward Current

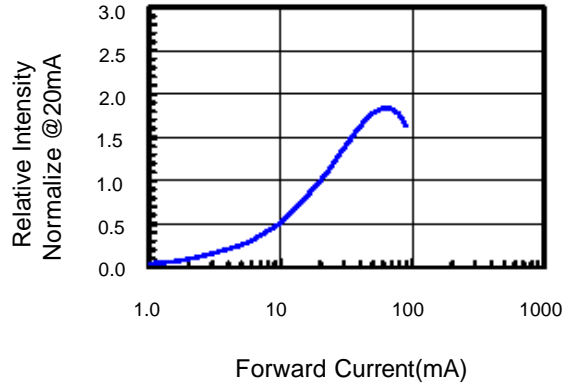

Fig.3 Forward Voltage vs. Temperature

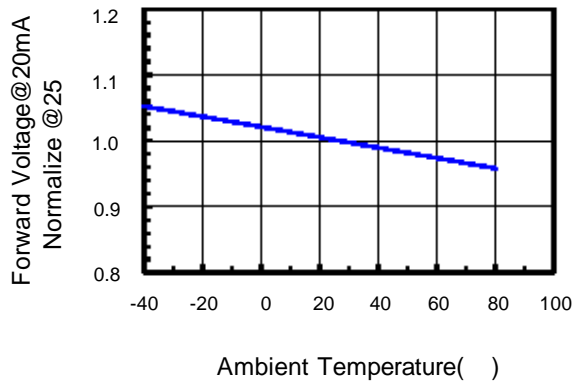

Fig.4 Relative Intensity vs. Temperature

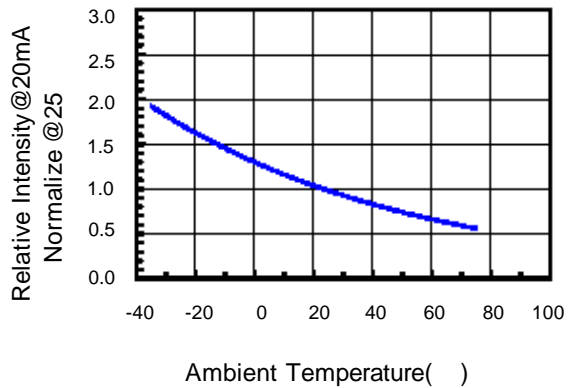

Fig.5 Relative Intensity vs. Wavelength

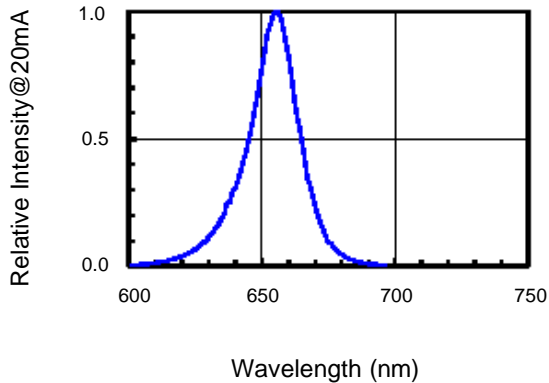
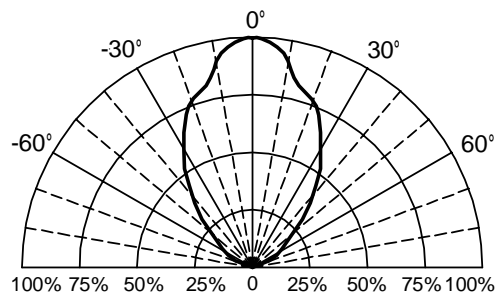

Fig.6 Directive Radiation





Typical Electro-Optical Characteristics Curve

G CHIP

Fig.1 Forward current vs. Forward Voltage

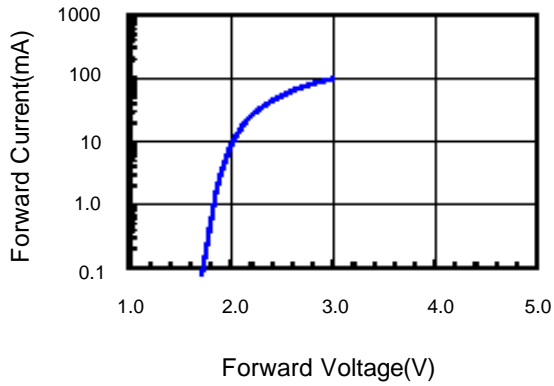

Fig.2 Relative Intensity vs. Forward Current

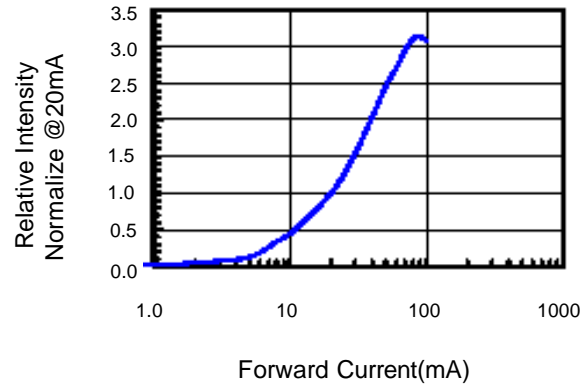

Fig.3 Forward Voltage vs. Temperature

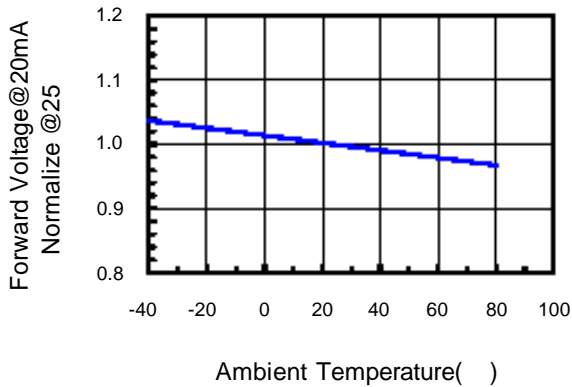

Fig.4 Relative Intensity vs. Temperature

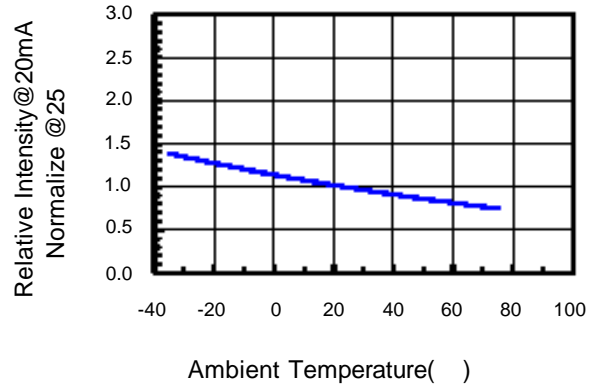

Fig.5 Relative Intensity vs. Wavelength

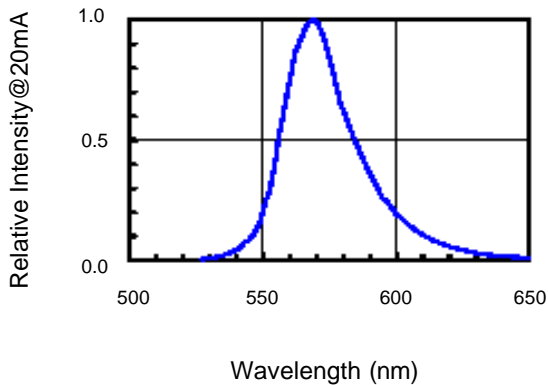
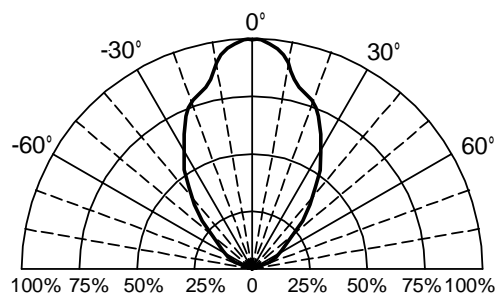

Fig.6 Directive Radiation





Soldering Condition(Pb-Free)

1.Iron:

Soldering Iron:30W Max
Temperature 350°C Max
Soldering Time:3 Seconds Max(One time only)
Distance:2mm Min(From solder joint to body)

2.Wave Soldering Profile

Dip Soldering
Preheat: 120°C Max
Preheat time: 60seconds Max
Ramp-up
2°C/sec(max)
Ramp-Down:-5°C/sec(max)
Solder Bath:260°C Max
Dipping Time:3 seconds Max
Distance:2mm Min(From solder joint to body)

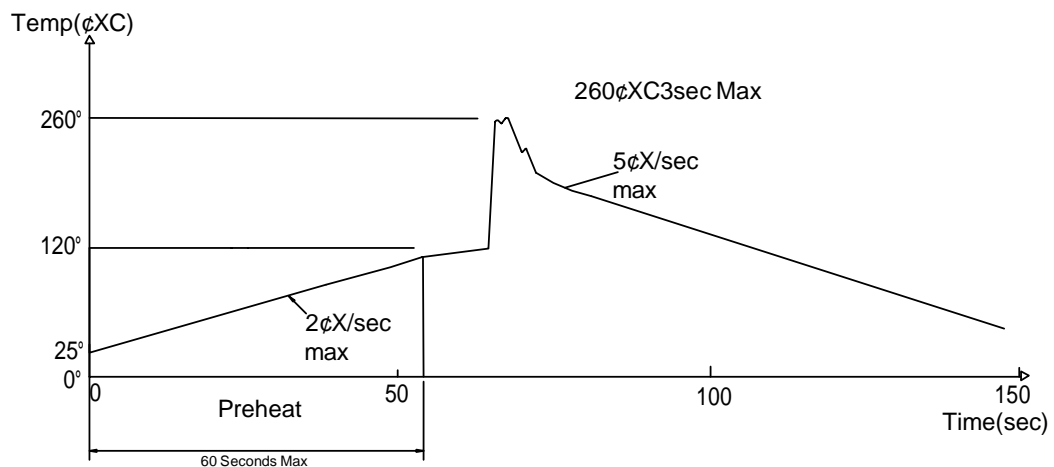

Note: 1.Wave solder should not be made more than one time.
2.You can just only select one of the soldering conditions as above.

**Reliability Test:**

Test Item	Test Condition	Description	Reference Standard
Operating Life Test	1.Under Room Temperature 2.If=20mA 3.t=1000 hrs (-24hrs, +72hrs)	This test is conducted for the purpose of determining the resistance of a part in electrical and thermal stressed.	MIL-STD-750: 1026 MIL-STD-883: 1005 JIS C 7021: B-1
High Temperature Storage Test	1.Ta=105 ±5 2.t=1000 hrs (-24hrs, +72hrs)	The purpose of this is the resistance of the device which is laid under condition of high temperature for hours.	MIL-STD-883:1008 JIS C 7021: B-10
Low Temperature Storage Test	1.Ta=-40 ±5 2.t=1000 hrs (-24hrs, +72hrs)	The purpose of this is the resistance of the device which is laid under condition of low temperature for hours.	JIS C 7021: B-12
High Temperature High Humidity Test	1.Ta=65 ±5 2.RH=90%~95% 3.t=240hrs ±2hrs	The purpose of this test is the resistance of the device under tropical for hours.	MIL-STD-202:103B JIS C 7021: B-11
Thermal Shock Test	1.Ta=105 ±5 & -40 ±5 (10min) (10min) 2.total 10 cycles	The purpose of this is the resistance of the device to sudden extreme changes in high and low temperature.	MIL-STD-202: 107D MIL-STD-750: 1051 MIL-STD-883: 1011
Solder Resistance Test	1.T.Sol=260 ±5 2.Dwell time= 10 ±1sec.	This test intended to determine the thermal characteristic resistance of the device to sudden exposures at extreme changes in temperature when soldering the lead wire.	MIL-STD-202: 210A MIL-STD-750: 2031 JIS C 7021: A-1
Solderability Test	1.T.Sol=230 ±5 2.Dwell time=5 ±1sec	This test intended to see soldering well performed or not.	MIL-STD-202: 208D MIL-STD-750: 2026 MIL-STD-883: 2003 JIS C 7021: A-2