

AN12941A

Audio power IC for notebook PC

Overview

The AN12941A is an amplifier IC for stereo speakers which can output 1 W by 8 Ω or 2 W by 4 Ω.

The AGC circuit is built-in to prevent the resonance or the vibration by the speaker's energy and the clipping distortion what is called "broken up sound." of the speakers.

Also, to reduce power consumption, AN12941A has a built-in function which automatically detects the input signal and can automatically enter power save mode when there is no signal.

Features

- Speaker amplifier is
 - 1 W × 2-channel: 8 Ω, $V_{CC} = 5\text{ V}$ or
 - 2 W × 2-channel: 4 Ω, $V_{CC} = 5\text{ V}$
- Built-in AGC circuit

Prevention of the resonance or the vibration by the speaker's energy and the clipping distortion of the speaker by AGC at excessive input signal (with AGC on/off switch).
- Built-in automatic power saving function

It detects input signals and switches on/off (with the on/off switch for the automatic power saving).
- Operating supply voltage: V_{CC} 3.0 V to 5.5 V / V_{CC_SP} 3.0 V to 5.5 V

Applications

- Notebook PC, LCD monitor with speaker

Block Diagram

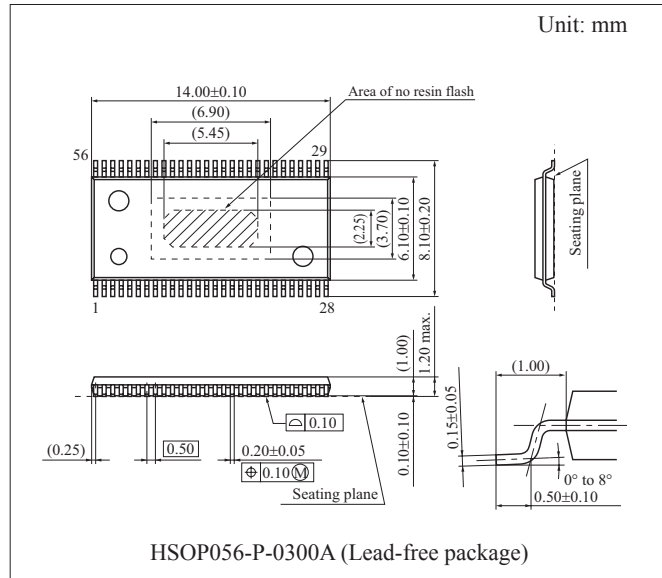
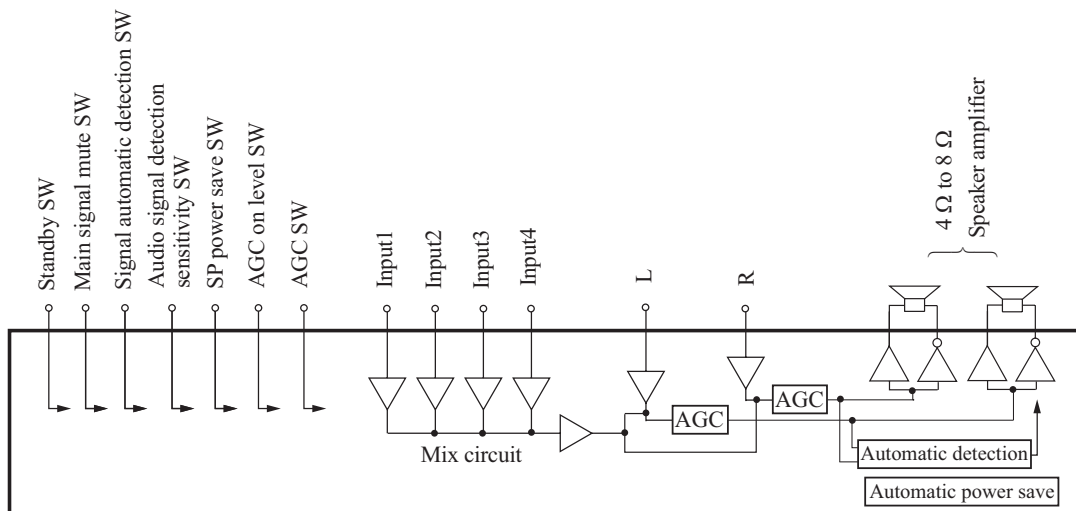

■ Application Circuit Example

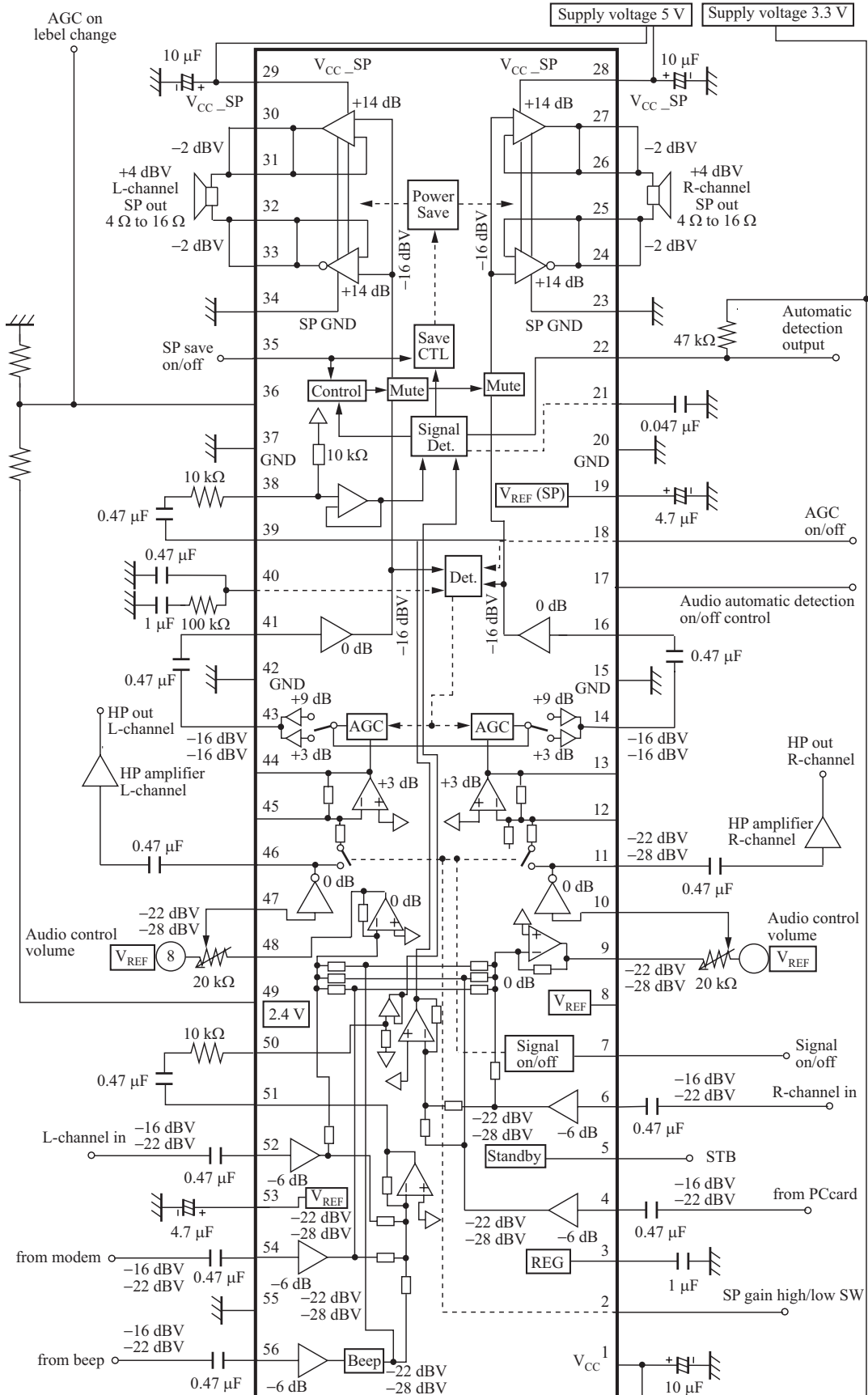

■ Pin Description

| Pin No. | Description | Pin No. | Description |
|---------|---|---------|---|
| 1 | V _{CC} | 29 | V _{CC_SP} L-channel |
| 2 | SP gain high/low SW | 30 | SP amplifier L-channel negative phase output (-) |
| 3 | REG ripple filter pin | 31 | SP amplifier L-channel negative phase output (-) |
| 4 | Input for PCard | 32 | SP amplifier L-channel positive phase output (+) |
| 5 | Standby on/off control | 33 | SP amplifier L-channel positive phase output (+) |
| 6 | R-channel input | 34 | GND_SP L-channel |
| 7 | Main signal mute on/off control | 35 | SP power save control |
| 8 | V _{REF} R-channel for volume | 36 | AGC on level control |
| 9 | Audio mix amplifier R-channel output | 37 | GND |
| 10 | Volume control signal R-channel input | 38 | Signal auto detection amplifier R-channel input |
| 11 | R-channel output for HP amplifier | 39 | Signal auto detection mix amplifier R-channel output |
| 12 | Negative feedback pin for alarm mix amplifier R-channel | 40 | AGC demodulation pin |
| 13 | Alarm mix amplifier R-channel output | 41 | SP amplifier L-channel input |
| 14 | AGC R-channel output | 42 | GND |
| 15 | GND | 43 | AGC L-channel output |
| 16 | SP amplifier R-channel input | 44 | Alarm mix amplifier L-channel output |
| 17 | Signal automatic detection on/off control | 45 | Negative feedback pin for alarm mix amplifier L-channel |
| 18 | AGC on/off control | 46 | L-channel output for HP amplifier |
| 19 | V _{REF_SP} | 47 | Volume control signal L-channel input |
| 20 | GND | 48 | Audio mix amplifier L-channel output |
| 21 | Demodulation pin for signal automatic detection | 49 | Voltage output for AGC level change |
| 22 | Signal automatic detection output | 50 | Signal auto detection amplifier L-channel input |
| 23 | GND_SP R-channel | 51 | Signal auto detection mix amplifier L-channel output |
| 24 | SP amplifier R-channel positive phase output (+) | 52 | L-channel input |
| 25 | SP amplifier R-channel positive phase output (+) | 53 | V _{REF} |
| 26 | SP amplifier R-channel negative phase output (-) | 54 | Input for modem |
| 27 | SP amplifier R-channel negative phase output (-) | 55 | GND |
| 28 | V _{CC_SP} R-channel | 56 | Input for beep |

Note) SP: Speaker
 HP: Headphone
 REG: Regulator

■ Absolute Maximum Ratings

| Parameter | Symbol | Rating | Unit |
|--|--------------------|--|------------------|
| Supply voltage *1 | V _{CC} | 5.75 | V |
| | V _{CC_SP} | 5.75 | |
| Supply current | I _{CC} | — | A |
| Power dissipation *2 | P _D | 517 | mW |
| Operating ambient temperature *3 | T _{opr} | −20 to +75 | °C |
| Storage temperature *3 | T _{stg} | −55 to +150 | °C |
| Operating ambient atmospheric pressure | P _{opr} | 1.013 × 10 ⁵ ± 0.61 × 10 ⁵ | Pa |
| Operating constant gravity | G _{opr} | 9 810 | m/s ² |
| Operating shock | S _{opr} | 4 900 | m/s ² |

Note) *1: The values under the condition the above absolute maximum ratings and the power dissipation.

*2: T_a = 75°C, the value under the condition which this device is mounted on a four-layer printed wiring board and in addition its radiation part is soldered. (Reference to ■ Technical Data, ● Power dissipation of package HSOP056-P-0300A)

*3: Except for the storage temperature and operating ambient temperature, all ratings are for T_a = 25°C.

■ Recommended Operating Range

| Parameter | Symbol | Rating | Unit |
|----------------|----------------------|------------|------|
| Supply voltage | V _{CC} | 3.0 to 5.5 | V |
| | V _{CC_SP} * | 3.0 to 5.5 | |

Note) *: The values under the condition the above absolute maximum ratings and the power dissipation.

■ Electrical Characteristics at V_{CC} = 5 V, V_{CC_SP} = 5 V

Note) T_a = 25°C ± 2°C unless otherwise specified.

| Parameter | Symbol | Conditions | Min | Typ | Max | Unit |
|--|--------------------|--|-----|-----|------|------|
| Circuit current | | | | | | |
| Circuit current 1A at non-signal (V _{CC}) | I _{VCCA} | V _{CC} = 3.3 V, at non-signal, Automatic distinction: on | 4.4 | 8.7 | 13.0 | mA |
| Circuit current 2A at non-signal (V _{CC_SP}) | I _{VCCSA} | V _{CC} = 3.3 V, at non-signal, Automatic distinction: on | — | 400 | 600 | μA |
| Circuit current 1B at non-signal (V _{CC}) | I _{VCCB} | V _{CC} = 3.3 V, at non-signal, Power save: off at non-automatic distinction | 4.8 | 9.5 | 14.2 | mA |
| Circuit current 2B at non-signal (V _{CC_SP}) | I _{VCCSB} | V _{CC} = 3.3 V, at non-signal, Power save: off at non-automatic distinction | — | 8.1 | 16.2 | mA |
| Circuit current 1C at non-signal (V _{CC}) | I _{VCCC} | V _{CC} = 3.3 V, at non-signal, Power save: on at non-automatic distinction | 4.1 | 8.1 | 12.1 | mA |
| Circuit current 2C at non-signal (V _{CC_SP}) | I _{VCCSC} | V _{CC} = 3.3 V, at non-signal, Power save: on at non-automatic distinction | — | 400 | 600 | μA |

■ Electrical Characteristics at $V_{CC} = 5\text{ V}$, $V_{CC_SP} = 5\text{ V}$ (continued)

Note) $T_a = 25^\circ\text{C} \pm 2^\circ\text{C}$ unless otherwise specified.

| Parameter | Symbol | Conditions | Min | Typ | Max | Unit |
|--|----------------------------|--|-----|------|-----|---------------|
| Circuit current (continued) | | | | | | |
| Circuit current 1D at non-signal (V_{CC}) | I_{VCCD} | $V_{CC} = 3.3\text{ V}$, at standby mode | — | 10 | 50 | μA |
| Circuit current 2D at non-signal (V_{CC_SP}) | I_{VCCSD} | $V_{CC} = 3.3\text{ V}$, at standby mode | — | 10 | 50 | μA |
| Speaker amplifier (Pin 52, pin 6 → pin 24 to pin 27, pin 33 to pin 30) | | | | | | |
| L-channel audio output level | V_{OSPL} | $V_{IN} = -22\text{ dBV}$, 1 kHz, $R_L = 8\ \Omega$ | 2.0 | 4.0 | 6.0 | dBV |
| R-channel audio output level | V_{OSPR} | $V_{IN} = -22\text{ dBV}$, 1 kHz, $R_L = 8\ \Omega$ | 2.0 | 4.0 | 6.0 | dBV |
| L-channel audio output distortion | TH_{SPL} | $V_{IN} = -22\text{ dBV}$, 1 kHz, $R_L = 8\ \Omega$, to THD fifth | — | 0.04 | 0.5 | % |
| R-channel audio output distortion | TH_{SPR} | $V_{IN} = -22\text{ dBV}$, 1 kHz, $R_L = 8\ \Omega$, to THD fifth | — | 0.04 | 0.5 | % |
| L-channel audio output noise | V_{NSPL} | At non-signal, $R_L = 8\ \Omega$, A curve filter | — | -65 | -62 | dBV |
| R-channel audio output noise | V_{NSPR} | At non-signal, $R_L = 8\ \Omega$, A curve filter | — | -74 | -68 | dBV |
| L-channel maximum output power | V_{M8SPL} | $V_{IN} = 1\text{ kHz}$, at THD = 10%, $R_L = 8\ \Omega$, to THD fifth, at AGC = off | 0.7 | 1.0 | — | W |
| R-channel maximum output power | V_{M8SPR} | $V_{IN} = 1\text{ kHz}$, at THD = 10%, $R_L = 8\ \Omega$, to THD fifth, at AGC = off | 0.7 | 1.0 | — | W |
| L-channel maximum output power | V_{M4SPL} | $V_{IN} = 1\text{ kHz}$, at THD = 10%, $R_L = 4\ \Omega$, to THD fifth, at AGC = off | — | 2.0 | — | W |
| R-channel maximum output power | V_{M4SPR} | $V_{IN} = 1\text{ kHz}$, at THD = 10%, $R_L = 4\ \Omega$, to THD fifth, at AGC = off | — | 2.0 | — | W |
| Cross talk R-channel → L-channel | V_{CTSPL} | $V_{IN} = -22\text{ dBV}$, 1 kHz, $R_L = 8\ \Omega$ A curve filter | 64 | 68 | — | dB |
| Cross talk L-channel → R-channel | V_{CTSPR} | $V_{IN} = -22\text{ dBV}$, 1 kHz, $R_L = 8\ \Omega$ A curve filter | 64 | 68 | — | dB |
| AGC output level | V_{AGSPL} V_{AGSPR} | $V_{IN} = -6\text{ dBV}$, 1 kHz, $R_L = 8\ \Omega$ A curve filter | 5.5 | 7.0 | 8.5 | dBV |
| Mix amplifier characteristic 1 (Pin 4, pin 54, pin 56 → pin 46, pin 11) | | | | | | |
| L-channel, R-channel output level at beep signal mix | V_{BESPL} V_{BESPR} | $V_{IN} = -10\text{ dBV}$, 1 kHz, pin 56 input | -17 | -16 | -15 | dBV |
| L-channel, R-channel output level at modem signal mix | V_{MDSPL} V_{MDSPR} | $V_{IN} = -10\text{ dBV}$, 1 kHz, pin 54 input | -17 | -16 | -15 | dBV |
| L-channel, R-channel output level at PCcard signal mix | V_{PCSPL} V_{PCSPR} | $V_{IN} = -10\text{ dBV}$, 1 kHz, pin 4 input | -17 | -16 | -15 | dBV |
| Each entry pin max input level | — | $V_{IN} = 1\text{ kHz}$, V_{IN} at THD = 1% | 0.6 | — | — | V[rms] |
| Maximum amplifier output for the HP amplifier | V_{HPMAL} V_{HPMAR} | $V_{IN} = 1\text{ kHz}$, V_{IN} at THD = 1% | 0.3 | — | — | V[rms] |

■ Electrical Characteristics at $V_{CC} = 5\text{ V}$, $V_{CC_SP} = 5\text{ V}$ (continued)

Note) $T_a = 25^\circ\text{C} \pm 2^\circ\text{C}$ unless otherwise specified.

| Parameter | Symbol | Conditions | Min | Typ | Max | Unit |
|---|--|--|-----|-----|-----|------|
| Mix amplifier characteristic 2 (continued) (Pin 56, pin 54, pin 52, pin 4, pin 6 → pin 44, pin 13) | | | | | | |
| L-channel, R-channel mix amplifier cross talk in case of signal off | V_{OFSPL} V_{OFSPR} | $V_{\text{IN}} = -16\text{ dBV}$, 1 kHz pins 4, 6, 52, 54, 56: input | — | -81 | -75 | dBV |
| Signal detection system characteristic (Pin 52, pin 6, pin 54, pin 56, pin 4 → pin 51, pin 39) | | | | | | |
| Pre-amplifier output at L-channel input | V_{SDTL} | $V_{\text{IN}} = -46\text{ dBV}$, 1 kHz | -22 | -20 | -18 | dBV |
| Pre-amplifier output at R-channel input | V_{SDTR} | $V_{\text{IN}} = -46\text{ dBV}$, 1 kHz | -22 | -20 | -18 | dBV |
| Pre-amplifier output at beep signal input | V_{SDTBE} | $V_{\text{IN}} = -46\text{ dBV}$, 1 kHz | -22 | -20 | -18 | dBV |
| Pre-amplifier output at modem signal input | V_{SDTMD} | $V_{\text{IN}} = -46\text{ dBV}$, 1 kHz | -22 | -20 | -18 | dBV |
| Pre-amplifier output at PCCard signal input | V_{SDTPC} | $V_{\text{IN}} = -46\text{ dBV}$, 1 kHz | -22 | -20 | -18 | dBV |
| Detection level 1 at high sensitivity | V_{SDTTH} | $V_{\text{IN}} = 1\text{ kHz}$ | -65 | -60 | -55 | dBV |
| Distinction output high level | V_{SDTHI} | $V_{\text{IN}} = 1\text{ kHz}$ | 2.3 | 3.3 | — | V |
| Distinction output low level | V_{SDTLO} | $V_{\text{IN}} = 1\text{ kHz}$ | — | 0.1 | 1.0 | V |
| Voltage holding mode | | | | | | |
| Entry signal on/off Voltage range holding on | V_{7H} | — | 2.0 | — | 5.0 | V |
| Entry signal on/off Voltage range holding off | V_{7L} | — | 0.0 | — | 0.8 | V |
| AGC on/off Voltage range holding on | V_{18H} | — | 2.0 | — | 5.0 | V |
| AGC on/off Voltage range holding off | V_{18L} | — | 0.0 | — | 0.8 | V |
| Signal automatic detection function Voltage range holding on | V_{17H} | — | 2.0 | — | 5.0 | V |
| Signal automatic detection function Voltage range holding off | V_{17L} | — | 0.0 | — | 0.8 | V |
| Sandby on/off Voltage range holding off | V_{5H} | — | 2.0 | — | 5.0 | V |
| Sandby on/off Voltage range holding on | V_{5L} | — | 0.0 | — | 0.8 | V |
| SP amplifier power save on/off Voltage range holding off | V_{35H} | — | 2.0 | — | 5.0 | V |
| SP amplifier power save on/off Voltage range holding on | V_{35L} | — | 0.0 | — | 0.8 | V |

■ Electrical Characteristics at $V_{CC} = 5\text{ V}$, $V_{CC_SP} = 5\text{ V}$ (continued)

Note) $T_a = 25^\circ\text{C} \pm 2^\circ\text{C}$ unless otherwise specified.

| Parameter | Symbol | Conditions | Min | Typ | Max | Unit |
|--|----------|------------|-----|-----|-----|------|
| Voltage holding mode (continued) | | | | | | |
| SP gain high/low SW +6 dB/0 dB Voltage range holding +6 dB | V_{2H} | — | 2.0 | — | 5.0 | V |
| SP gain high/low SW +6 dB/0 dB Voltage range holding 0 dB | V_{2L} | — | 0.0 | — | 0.8 | V |

■ Control terminal , The mode table

| Pin No. | Pin Name | Voltage of Pin | | Remarks |
|---------|-------------------------------------|---------------------------|--------------------------|--|
| | | Low | High | |
| 7 | Entry signal on/off | Signal off | Signal on | — |
| 18 | AGC on/off | AGC off | AGC on | — |
| 17 | Signal automatic detection function | Automatic distinction off | Automatic distinction on | — |
| 5 | Standby on/off | STB on | STB off | — |
| 35 | SP power save on/off | Save on (SP off) | Save off (SP on) | The power saving operation by pin 35 has priority over any automatic detection |
| 2 | SP gain high/low SW | 0 dB | +6 dB | The gain difference is about 6 dB |

| Pin No. | Pin Name | Voltage of Pin |
|---------|---|--------------------------|
| | | 0.5 V to 1.5 V |
| 36 | At the time of AGC: on, It changes on level. | On level: -3 dB to +3 dB |

Note) *: The holding range of control voltage is shown in page 6 to page 7 of ■ Electrical Characteristics.

■ Terminal Equivalent Circuits

| Pin No. | Equivalent Circuits | Description | Corrugation and Voltage |
|-----------|---------------------|--|-------------------------|
| 28, 29 | — | V_{CC_SP} : It is the specifically designed power pin of the speaker amplifier. • Pin 28 is for R-channel • Pin 29 is for L-channel Because the big electric current flows, it is desirable to separate from the V_{CC} line to the other power pin on the board pattern. | DC 5 V |

■ Terminal Equivalent Circuits (continued)

| Pin No. | Equivalent Circuits | Description | Corrugation and Voltage |
|--|---------------------|---|--|
| 24, 25, 26, 27 30, 31, 32, 33 | | <p>Speaker Output: It is output pins of the speaker amplifier. It becomes BTL output.</p> <p>The L-channel positive phase output pin: Pin 32, pin 33</p> <p>The L-channel negative phase output pin: Pin 30, pin 31</p> <p>The R-channel positive phase output pin: Pin 24, pin 25</p> <p>The R-channel negative phase output pin: Pin 30, pin 31 Pin 26, pin 27</p> <p>To reduce voltage loss by the wire resistance in maximum output, it makes output 2 pins. Also, when the speaker amplifier saves power, too, DC voltage is maintained.</p> <p>The output impedance: Equal to or less than 10 Ω</p> | <p>DC 2.2 V AC 4 dBV</p> <p>Pin 32, pin 33 Pin 24, pin 25 positive</p> <p>Pin 30, pin 31 Pin 26, pin 27 negative</p> |
| 23, 34 | — | <p>GND: It is GND pin for the speaker amplifier.</p> <ul style="list-style-type: none"> • Pin 23 is for R-channel • Pin 34 is for L-channel <p>Because the big electric current flows, it is desirable to separate from the GND line to the other GND pin on the board pattern. Also, it isn't connected with the substrate potential in the IC.</p> | <p>DC 0 V</p> |
| 22 | | <p>Audio signal automatic detection distinction output: It outputs the distinction result of the audio signal automatic detection circuit.</p> <p>The output form is the open collector output from of the NPN transistor. Therefore, the pull rises and uses for the power by the external resistance (equal to or more than 10 kΩ).</p> <p>Signal's there being: Output high Signal nothing: Output low</p> <p>Open collector output The electric current ability: Equal to or more than 100 μA</p> | <p>Signal nothing DC 0 V Signals there being DC 3.3 V</p> |

■ Terminal Equivalent Circuits (continued)

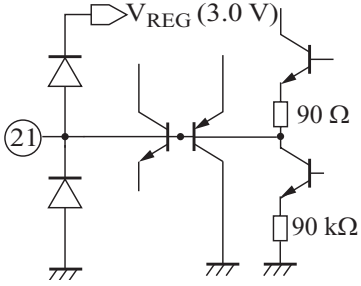
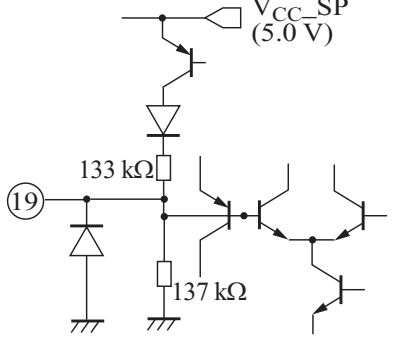
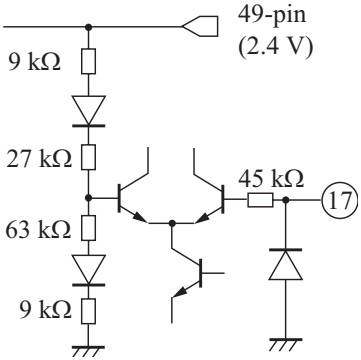
| Pin No. | Equivalent Circuits | Description | Corrugation and Voltage |
|--------------------------------|---|---|--|
| 21 |  | <p>Audio automatic detecting detection pin: It connects a condenser for the peak detection. It is the circuit which detects a peak after rectifying the audio signal of the audio signal automatic detection circuit in both waves. By changing a capacity value, the time which the power saving depends on in case of the switchover which is without signal with signal's there being can be changed.</p> <p>Signal less time: Constant current source</p> <p>Signal's there being: Emitter follower</p> <p>The output impedance: About 200 Ω</p> | <p>Signal nothing DC 0 V</p> <p>Signals there being DC 2 V</p> |
| 15, 20, 37, 42, 55 | <p style="text-align: center;">—</p> | <p>GND: It is the GND pin of the signal system. It is connected with the substrate potential of the IC. Pin 15, pin 42 connect with the lead frame of the IC.</p> | <p>DC 0 V</p> <hr style="width: 50%; margin-left: auto; margin-right: 0;"/> |
| 19 |  | <p>V_{REF_SP}: It is the standard voltage pin to fix the DC bias of the speaker output. It connects a condenser to remove a ripple.</p> <p>The output impedance: About 60 kΩ</p> | <p>DC 2.2 V</p> <hr style="width: 50%; margin-left: auto; margin-right: 0;"/> |
| 17 |  | <p>Signal automatic detection function on/off control pin: We change an audio signal automatic detection function in on/off. In case of automatic detection off, it controls power saving by speaker with the manual with the power saving on/off pin.</p> <p>High: Function on Low: Function off</p> <p>The entry impedance: The high impedance</p> | <p>DC —</p> <hr style="width: 50%; margin-left: auto; margin-right: 0;"/> |

■ Terminal Equivalent Circuits (continued)

| Pin No. | Equivalent Circuits | Description | Corrugation and Voltage |
|-----------|---------------------|---|--------------------------------|
| 16, 41 | | <p>Speaker amplifier entry:</p> <p>It is the voice input pins of the speaker amplifier. To make offset voltage in power saving on/off changing by the Speaker amplifier little, it combines capacity. (It makes pop noise small).</p> <p>Pin 16: R-channel SP amplifier entry Pin 41: L-channel SP amplifier entry The entry impedance: About 50 kΩ</p> | <p>DC 1.5 V AC -16 dBV</p> |
| 14, 43 | | <p>AGC amplifier output:</p> <p>It is the output pin of the AGC circuit to hold an output clip in excessive output of the speaker output.</p> <p>Pin 14: The AGC R-channel output Pin 43: The AGC L-channel output The output impedance: Equal to or less than about 10 Ω</p> | <p>DC 1.5 V AC -16 dBV</p> |
| 13, 44 | | <p>Alarm mix amplifier output pins:</p> <p>It is output pins of the mix amplifier to mix an alarm signal and an audio signal.</p> <p>Pin 13: R-channel output Pin 44: L-channel output The output impedance: Equal to or less than about 10 Ω</p> | <p>DC 1.5 V AC -25 dBV</p> |
| 12, 45 | | <p>Alarm mix amplifier negative feedback pins:</p> <p>It is the negative feedback of the mix amplifier to mix an alarm signal and an audio signal. It is possible to adjust in the direction which lowers the gain of the mix amplifier in putting resistance among above mentioned mix amplifier output pins.</p> <p>Pin 12: R-channel negative feedback pin Pin 45: L-channel negative feedback pin The entry impedance: The high impedance</p> | <p>DC 1.5 V</p> |







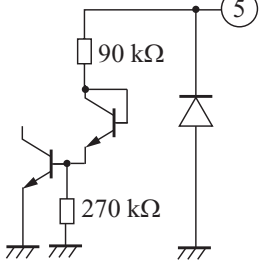

■ Terminal Equivalent Circuits (continued)

| Pin No. | Equivalent Circuits | Description | Corrugation and Voltage |
|---------|---------------------|--|--------------------------------|
| 9, 48 | | <p>Audio signal mix amplifier output pin: It is the output of the mix amplifier to mix a signal from the modem, the beep, the PCCard to an audio signal.</p> <p>Pin 9: The R-channel output Pin 48: The L-channel output</p> <p>The output impedance: Equal to or less than about 10 Ω</p> | <p>DC 1.5 V AC -28 dBV</p> |
| 10, 47 | | <p>Entry for EVR: It is the amplifier entry to adjust an output level to the HP amplifier. It becomes the entry of the EVR adjustment signal.</p> <p>The entry impedance: The high impedance</p> | <p>DC — AC -28 dBV</p> |
| 7 | | <p>Audio signal on/off changing control pin: It is the control pin which changes whether to communicate an audio signal to the amplifier to mix an alarm signal and an audio signal. At the time of off, only an alarm audio is output from the mix amplifier.</p> <p>High: Signal on Low: Signal off</p> <p>The entry impedance: The high impedance</p> | <p>DC —</p> |
| 6, 52 | | <p>Audio signal input: It enters a main audio signal.</p> <p>Pin 6: R-channel entry Pin 52: L-channel entry</p> <p>The entry impedance: About 45 kΩ</p> | <p>DC 1.5V AC -22 dBV</p> |

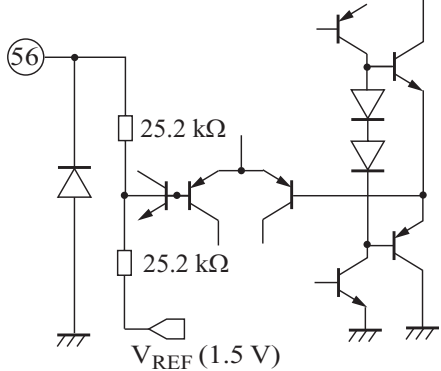
■ Terminal Equivalent Circuits (continued)

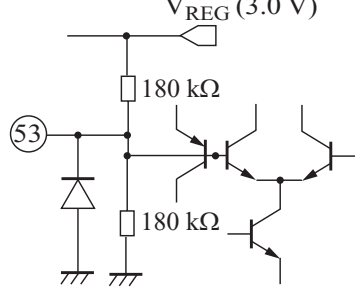
| Pin No. | Equivalent Circuits | Description | Corrugation and Voltage |
|---------|---------------------|--|-------------------------------|
| 4 | | <p>PCcard signal entry:</p> <p>It is the entry pin to enter a signal from the PCard. With the audio signal mix amplifier of the following paragraph, the same signal is entered both by L-channel and R-channel. Also, it has the function which is the same as the beep entry of pin 56, the modem entry by pin 54 completely. The entry impedance: About 45 kΩ</p> | <p>DC 1.5V AC -16 dBV</p> |
| 3 | | <p>Ripple removal condenser pin for the regulator:</p> <p>To remove a power ripple with the regulator circuit to create the inner power (V_{REG}), it puts a condenser. The entry impedance: About 100 kΩ</p> | <p>DC 1.5 V</p> |
| 2 | | <p>SP gain high/low CTL:</p> <p>It is the terminal which controls gain 0 dB/+6 dB of SP output.</p> <p>High: +6 dB Low: 0 dB</p> <p>The entry impedance: The high impedance</p> | <p>DC —</p> |
| 1 | — | <p>V_{CC} :</p> <p>It is the power (V_{CC}) pin to supply the regulator circuit to create the inner power V_{REG} with the voltage. It is separating from V_{CC_SP} of pin 28, pin 29 fully inside. It is desirable to separate as far as it finishes coming out about the P board pattern, too.</p> | <p>DC 3.3 V</p> |

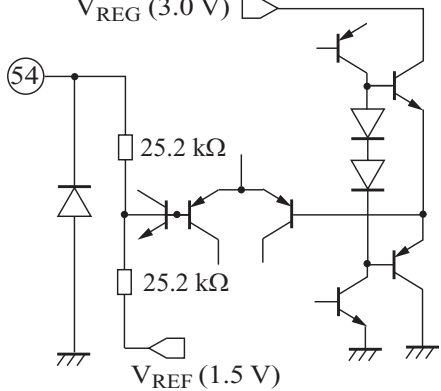
■ Terminal Equivalent Circuits (continued)

| Pin No. | Equivalent Circuits | Description | Corrugation and Voltage |
|---------|---|---|--|
| 5 |  | <p>Standby on/off changing SW: It changes whether or not it makes this IC an operation condition or whether or not it makes it a standby. High: The operation condition Low: Standby In that the power changes a connected condition to the standby, the circuit electric current can be almost made 0. The entry impedance: About 80 kΩ</p> | <p>Open voltage DC 0 V</p>  |
| 56 |  | <p>Beep input: It is the entry pin to enter beep signal. The same signal is entered both by L-channel and R-channel with the audio signal mix amplifier of the following paragraph. Also, it has the function which is the same as the PCcard signal entry by pin 4, the modem signal entry by pin 54 completely. The entry impedance: About 45 kΩ</p> | <p>DC 1.5 V AC -22 dBV</p>  |
| 53 |  | <p>V_{REF}: With the pin to fix the bias voltage (the operation point) of the system which the inner power (V_{REG}) works, it becomes 1/2V_{REG} (V). To remove noise, it connects a condenser with the interval of between pin 53 and GND. The entry impedance: About 80 kΩ</p> | <p>DC 1.5 V</p>  |
| 54 |  | <p>Modem input: It is the entry pin to enter a signal from the modem. With the audio signal mix amplifier of the following paragraph, the same signal is entered both by L-channel and R-channel. Also, it has the function which is the same as the PCcard signal entry by pin 4, the beep signal entry by pin 56 completely. The entry impedance: About 45 kΩ</p> | <p>DC 1.5 V AC -22 dBV</p>  |

■ Terminal Equivalent Circuits (continued)

| Pin No. | Equivalent Circuits | Description | Corrugation and Voltage |
|-----------|---------------------|---|--------------------------------|
| 39, 51 | | <p>The signal detection system pre-amplifier negative return terminal:</p> <p>It is the output terminal for signal detection system pre-amplifier.</p> <p>The output impedance: Equal to or less than about 10 Ω</p> | <p>DC 1.5 V AC -22 dBV</p> |
| 38, 50 | | <p>The signal detection system pre-amplifier input terminal:</p> <p>It is the input terminal for signal detection system pre-amplifier.</p> <p>The entry impedance: About 10 kΩ</p> | <p>DC 1.5 V AC -22 dBV</p> |
| 40 | | <p>AGC detection pin:</p> <p>It is the detection circuit to detect the signal level of the AGC circuit of the SP output for the clip prevention.</p> <p>It connects a condenser for the detection.</p> <p>The entry impedance: Unsettled</p> | <p>DC 0 V to 1 V</p> |
| 18 | | <p>AGC on/off control pin:</p> <p>It is the pin which controls the operating operation of the AGC circuit of the SP output for the clip prevention in on/off. At the time of off, the AGC circuit doesn't work.</p> <p>High: AGC on Low: AGC off</p> <p>The entry impedance: The high impedance</p> | <p>DC —</p> |

■ Terminal Equivalent Circuits (continued)

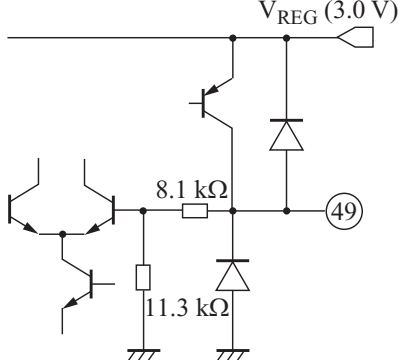
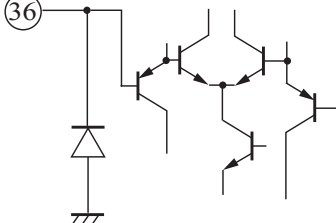
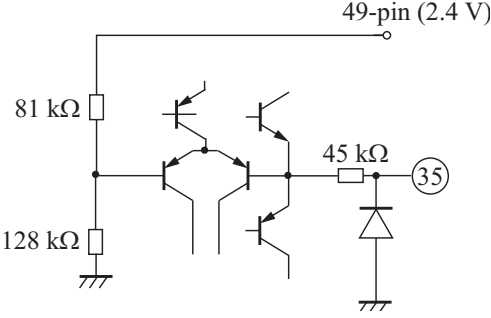
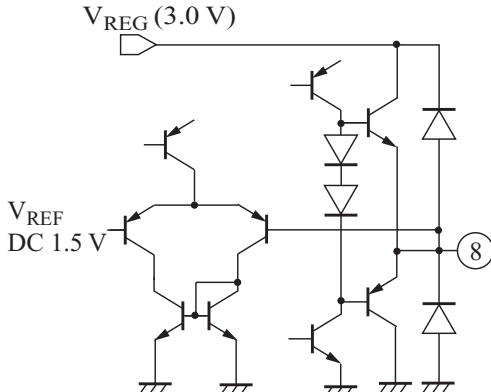
| Pin No. | Equivalent Circuits | Description | Corrugation and Voltage |
|---------|---|---|-------------------------|
| 49 |  | <p>DC output for the AGC on level adjustment: It is an DC voltage output terminal for the AGC on level adjustment. The output impedance: Equal to or less than about 10 Ω</p> | DC 2.4 V |
| 36 |  | <p>It changes AGC on level: It is the pin which changes the on level of AGC. The entry impedance: The high impedance</p> | DC 1.5 V |
| 35 |  | <p>SP amplifier power saving on/off control pin: It is the pin which controls power saving by the SP amplifier. At the time of on in addition to the control in case of automatic distinction function off, too, power saving on by pin 50 has priority over. The entry impedance: The high impedance</p> | DC 1.3 V |
| 8 |  | <p>Standard bias source for EVR: It is possible to use as GND (the DC bias source) AC when connecting external EVR. It is possible to attenuate in the AC signal without cutting a signal system in "C". The output impedance: Equal to or less than about 10 Ω</p> | DC 1.5 V |

■ Terminal Equivalent Circuits (continued)

| Pin No. | Equivalent Circuits | Description | Corrugation and Voltage |
|-----------|---------------------|---|--------------------------------|
| 11, 46 | | <p>Output pins for the HP amplifier: It is output pins for the external HP amplifier. The signal which was adjusted in the volume in EVR can be output by the low impedance. The output impedance: Equal to or less than about 10 Ω</p> | <p>DC 1.5 V AC -28 dBV</p> |

■ Application Notes

• Circuit Descriptions

1. Input inverting amplifier and signal mix circuit block

• Input inverting amplifier block

- 1) The input impedance of each input pin is about 50 kΩ.
- 2) Each input impedance is ±10% of variation exists by diffusion variation.
- 3) The gain of the input part is able to lowered by adding resistance to input pin in series.
When addition resistance is set to Ra (kΩ)

$$Ga = \frac{25.2}{50 + Ra}$$

• Signal mix circuit block

- 1) It is added (mix) in the inverting amplifier method.
Mix ratio is 1 to 1 for each input.
- 2) Connect volume to this mix amplifier output, allowing you to vary the next stage input level.
- 3) Pin 8 is the V_{REF} output pin for volume reference.

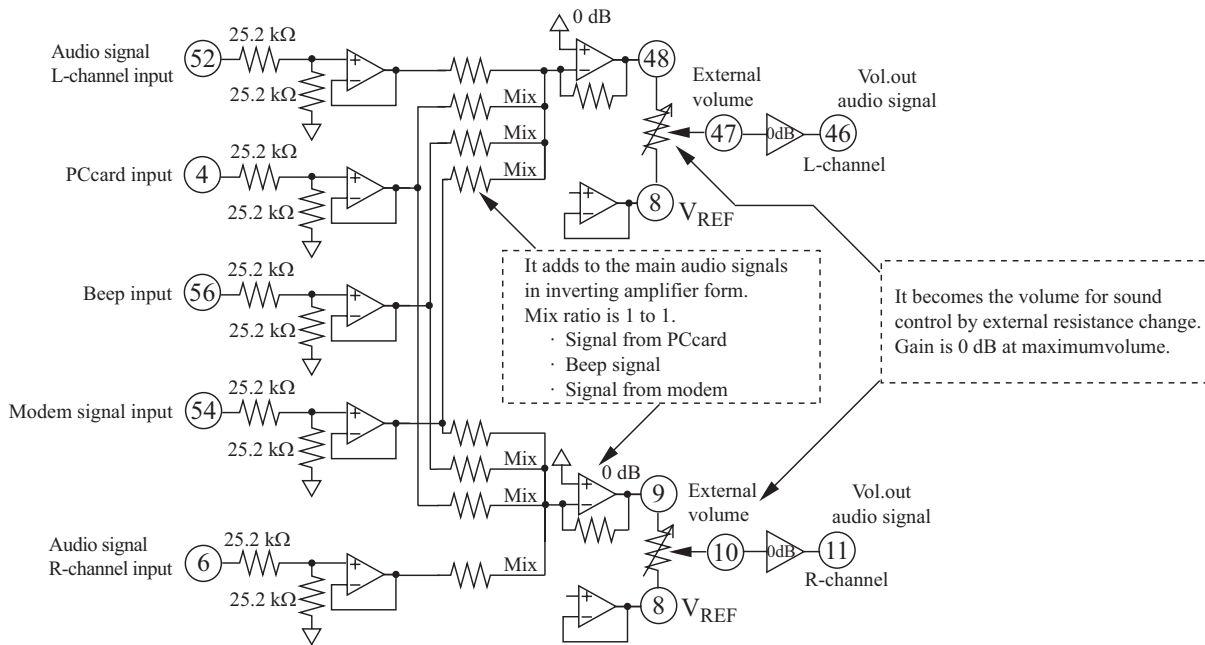

■ Application Notes (continued)

2. Signal detection system mix circuit block

• Signal detection system mix circuit block

- 1) Each input signal in accordance with mix ratio of 1 to 1.

Signals are detected by separate systems to prevent cancellation in the case of negative phase input for main signal R-channel and L-channel.

- Main audio signal L-channel
- Main audio signal R-channel
- Beep signal
- Signal from PCCard
- Signal from modem

- 2) Signal detection sensitivity can be adjusted with 10 k Ω external resistance connected between pin 50 and pin 51 or pin 38 and pin 39.

- 3) The signals input via pin 38 and pin 50 first undergo double-wave rectification, and then peak detection is performed using the external condenser connected to pin 21.

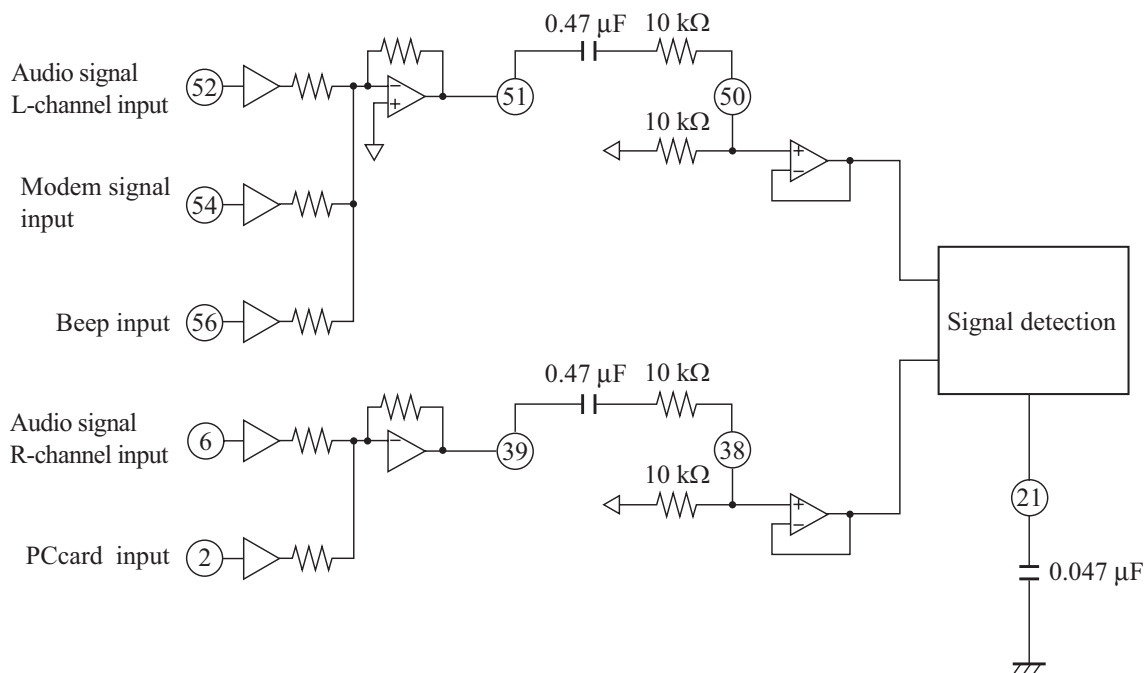

Note) Adjust the detection sensitivity using 10 k Ω external resistance. If noise is high for the set, use more than 10 k Ω (between about 10 k Ω and 200 k Ω).

■ Application Notes (continued)

2. Signal detection system mix circuit block (continued)

Detection sensitivity threshold values vs. external resistance

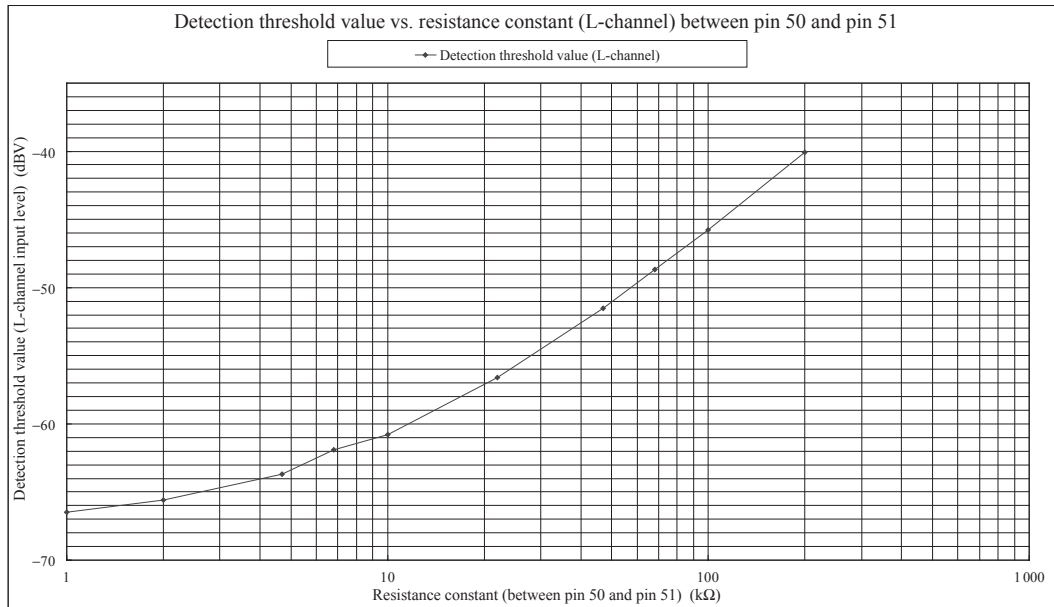

- Power save of speaker power amplifier
 - 1) When input signal level is lower than a certain value due to signal automatic detection circuit, power save of speaker power amp will be operated.
 - 2) This automatic detecting function is able to stopped by pin 17.
 - 3) When the automatic detection is off, it control manual control by pin 35.
 - 4) Also when the automatic detection is on, manual power save on is prioritized.
When it control only the automatic detecting function, set pin 35 to power save off.
- Signal detecting distinction output
 - 1) The result of automatic signal detection is output from pin 22.

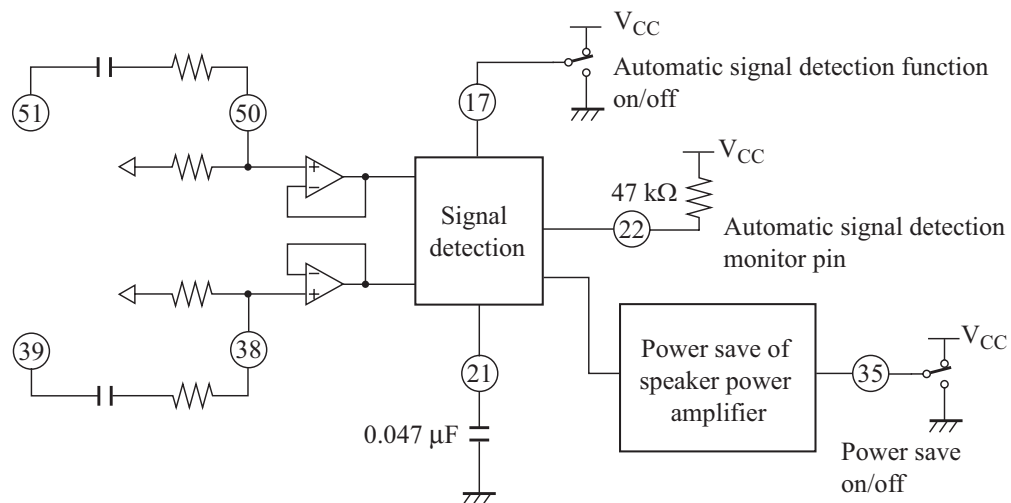

■ Application Notes (continued)

3. Main signal on/off change and alarm signal mix circuit block

- Main signal on/off circuit
 - 1) The speaker amplifier section is set to Mute when main signal is off.
 - 2) High: Signal on , Low: Signal off
 - Main signal level adjustment
 - 1) The gain of this inverting amplifier can be reduced by adding external resistance in parallel between pin 12 and pin 13 or pin 44 and pin 45.
- When addition resistance is set to R_d (k Ω)

$$G_d = \frac{18 \times (9 + R_d)}{12.7 \times (18 + 9 + R_d)}$$

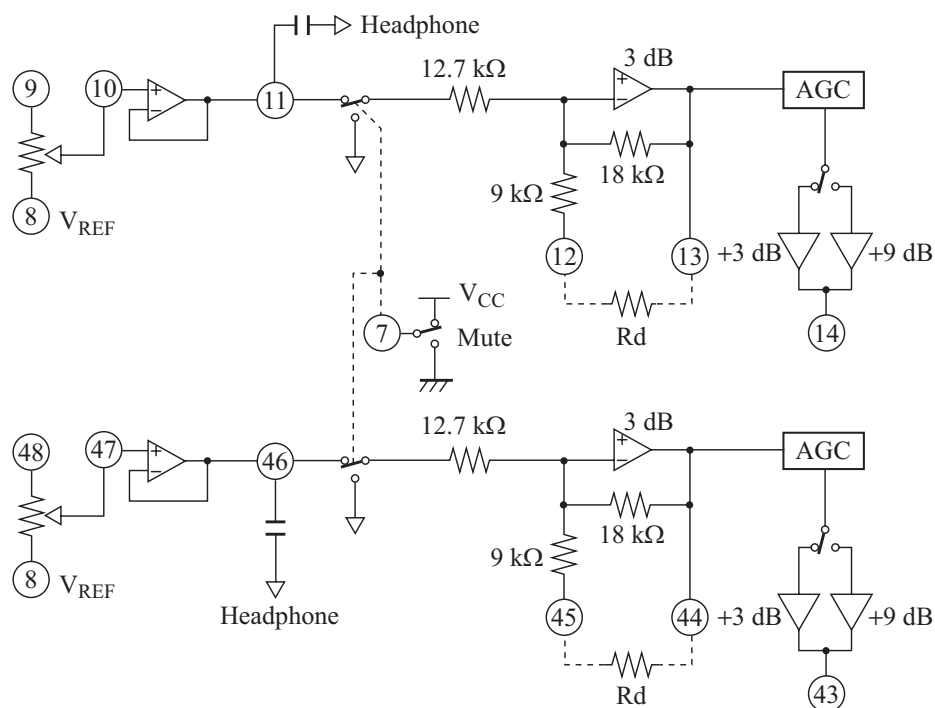

■ Application Notes (continued)

4. Signal detection system mix circuit block

• AGC detection

- 1) The signal inputted from pin 41 and pin 16 is rectified on both waves and then mixed with L + R.
- 2) The above signal is peak-detected by the external part of pin 40. External is giving double-detection constant.
- 3) When the voltage of pin 40 is equal or more than 0.7 V, AGC is on.

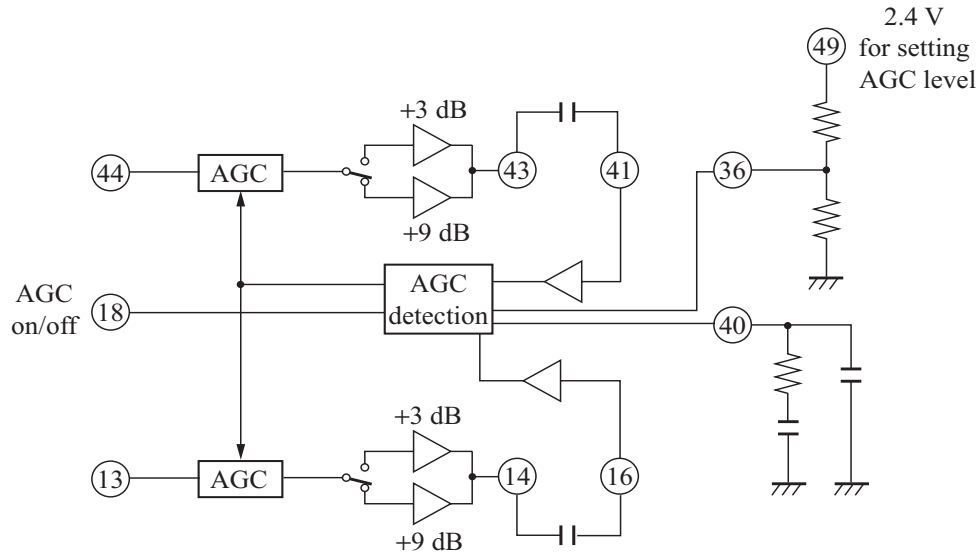

• The output wave at the time of AGC operation

It is the following output wave form chart at the AGC operation time.

Graph showing output wave when identical sound signals are input to two AN12941A ICs, one with AGC set to off and the other with AGC set to on.

Using identical input signals, $V_{CC}, V_{CC_SP} = 5\text{ V}$
 $R_L = 8\ \Omega$

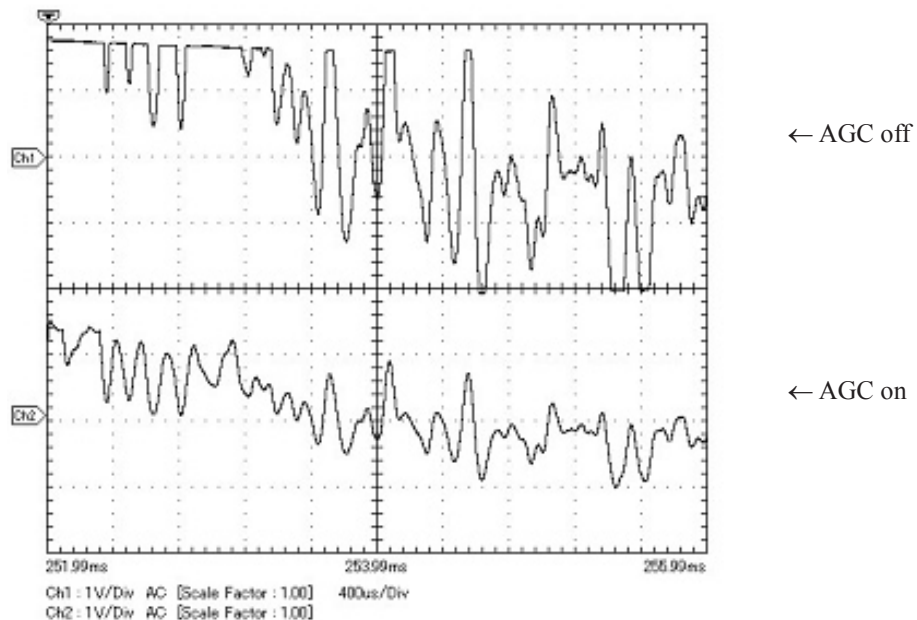

■ Application Notes (continued)

5. Speaker amplifier circuit block

- DC shift circuit

- 1) Shift circuit operating point of signal (bias voltage at a no signal) from V_{REF} to V_{REF_SP} .
DC voltage (speaker output) of output becomes V_{REF_SP} .

- Speaker amplifier

- 1) Speaker amplifier is BTL amplifier system of 2-channel.

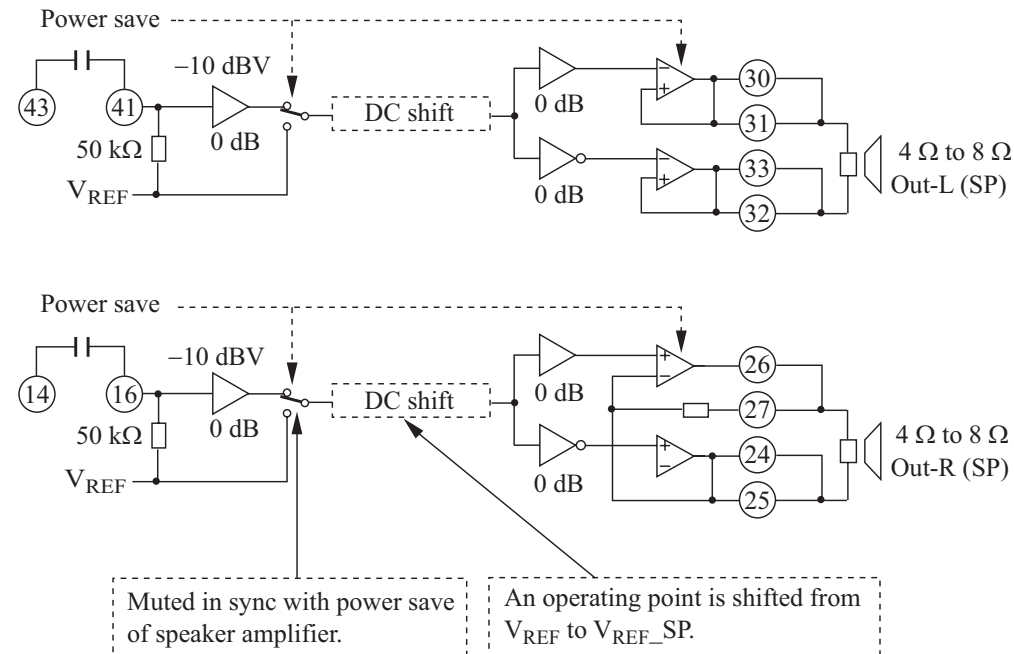

6. Control order at power supply on/off change

- Power supply on

When switching power on, it is recommended to use a speaker amplifier during a transient period from power on till a stable condition of a circuit to ensure that a circuit start up smoothly by protecting from any shock noise of a speaker circuit.

- 1) Control order

1. Power supply (V_{CC_SP} , V_{CC}): Change off to on
2. Standby control: Change on to off
3. Speaker amplifier power save control: Change on to off

■ Application Notes (continued)

6. Control order at power supply on/off change (continued)

- Power supply on (continued)
 - 2) Control timing

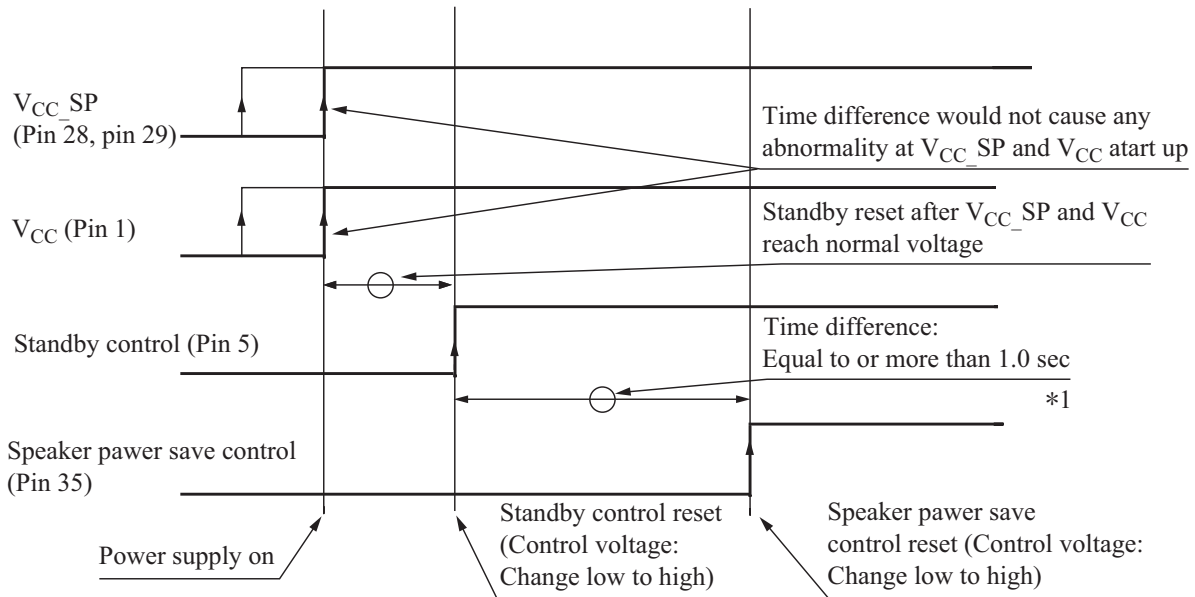

Note) *1: Time covering from standby control cancellation until a circuit stabilization to normal state.
 It depends on the capacitance connected to reference voltage (V_{REF} , V_{REF_SP}) pin.
 It is recommendation value of 4.7 μ F.

- Power supply off

When switching power off, it is recommended to take the order of first applying power save control to a speaker amplifier so that a circuit transient change may not effect on a speaker output.

- 1) Control order
 1. Speaker amplifier power save control: Change off to on
 2. Standby control: Change off to on
 3. Power supply (V_{CC_SP} , V_{CC}): Change on to off

■ Application Notes (continued)

6. Control order at power supply on/off change (continued)

- Power supply off (continued)
 - 2) Control timing

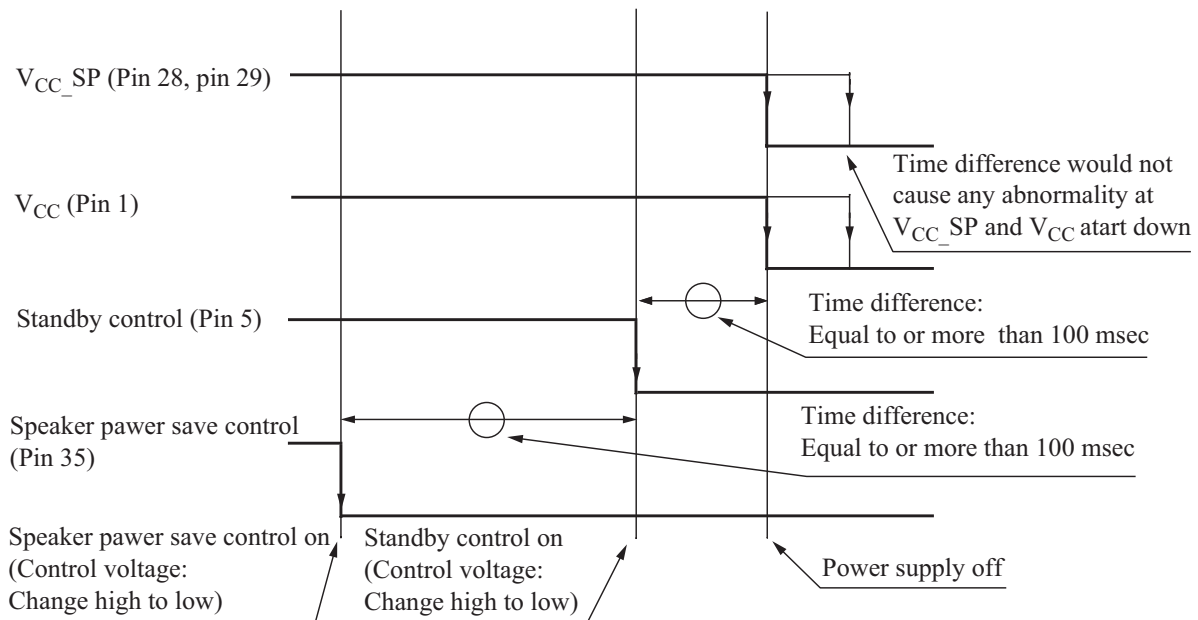

- After power supply start up (Usual operating condition)

Shock noise is likely to occur if you switch a standby control without applying a speaker power save. Therefore, do not forget to apply speaker save before switching to standby control.

7. Power dissipation of package HSOP056-P-0300A

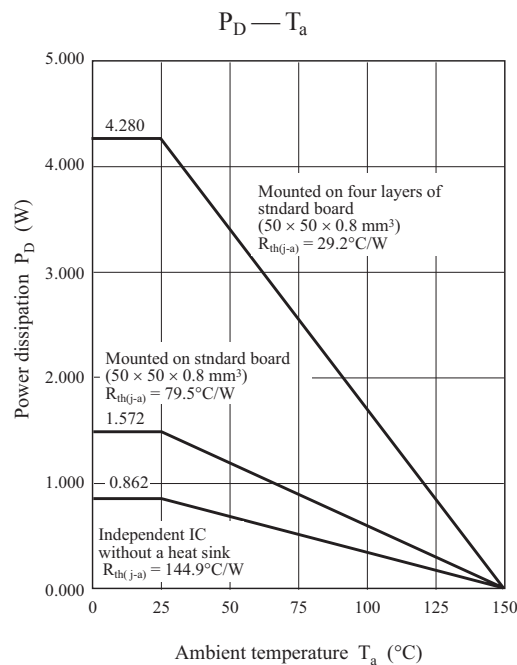

Note) The above characteristic is a reference value in case of design and is not a guarantee value.

■ Application Notes (continued)

• Main characteristics

1) I/O characteristics, frequency characteristics

(1) SP I/O level, distortion characteristics (R-channel, L-channel)

AGC = Off, Automatic detection = On, SP gain setting = High, $V_{CC} = 3.3\text{ V}$, $V_{CC_SP} = 5.0\text{ V}$,
 Input frequency = 1 kHz, R-out = 8 Ω , HPF: 400 Hz, LPF: 30 kHz

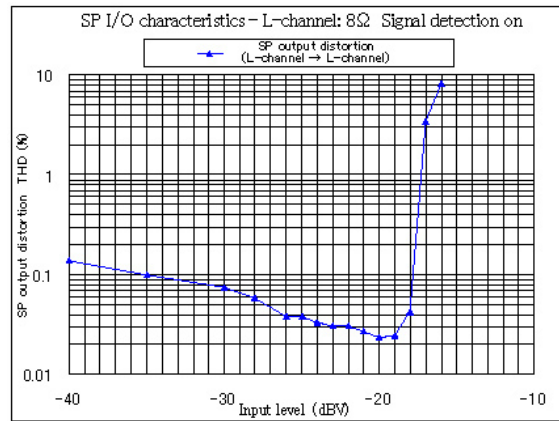
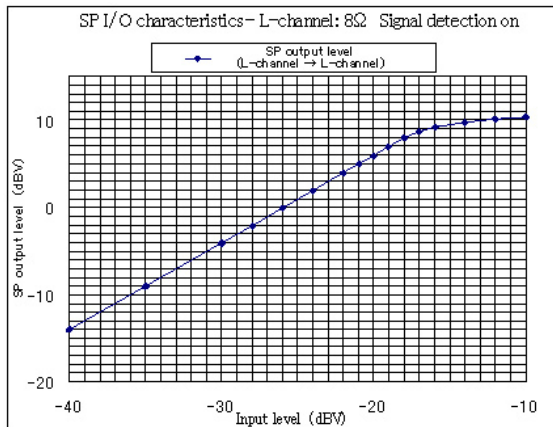
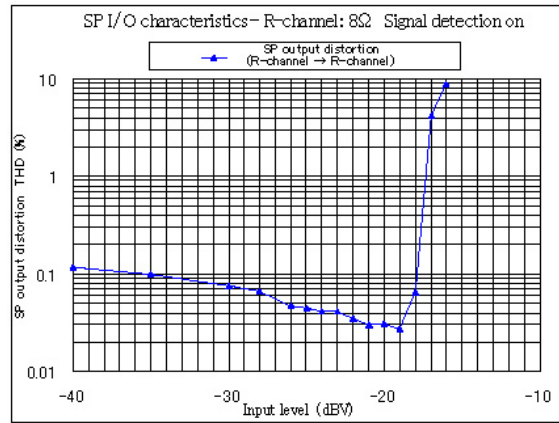
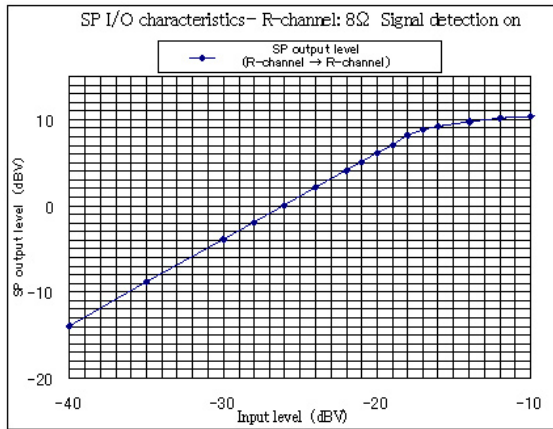

■ Application Notes (continued)

• Main characteristics (continued)

1) I/O characteristics, frequency characteristics (continued)

(1) SP I/O level, distortion characteristics (R-channel, L-channel) (continued)

AGC = Off, Automatic detection = On, SP gain setting = Low, $V_{CC} = 5.0\text{ V}$, $V_{CC_SP} = 5.0\text{ V}$,
 Input frequency = 1 kHz, HPF: 400 Hz, LPF: 30 kHz

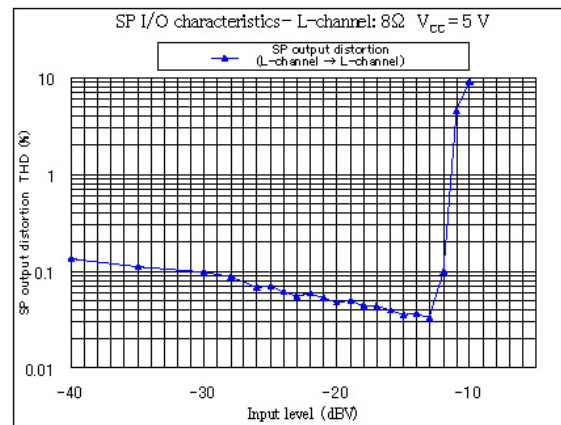
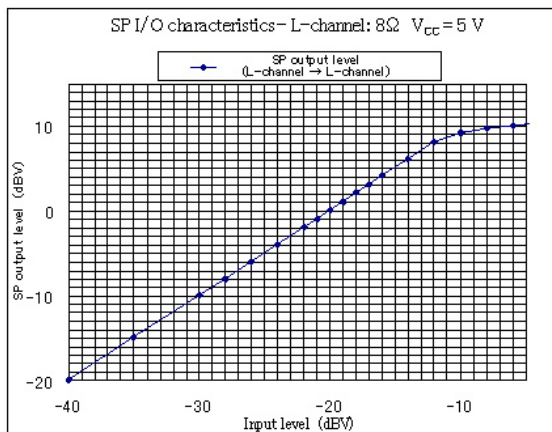
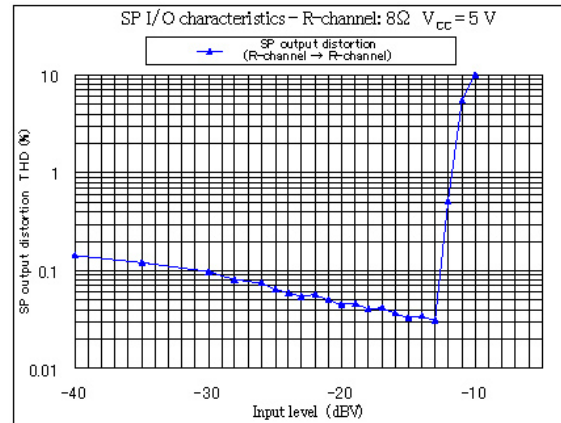
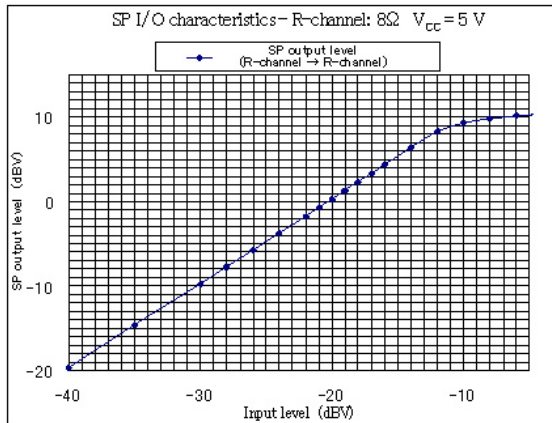

■ Application Notes (continued)

• Main characteristics (continued)

1) I/O characteristics, frequency characteristics (continued)

(2) SP I/O level, distortion characteristics (Beep)

AGC = Off, Automatic detection = Off, SP gain setting = High, $V_{CC} = 3.3\text{ V}$, $V_{CC_SP} = 5.0\text{ V}$,
 Input frequency = 1 kHz, HPF: 400 Hz, LPF: 30 kHz

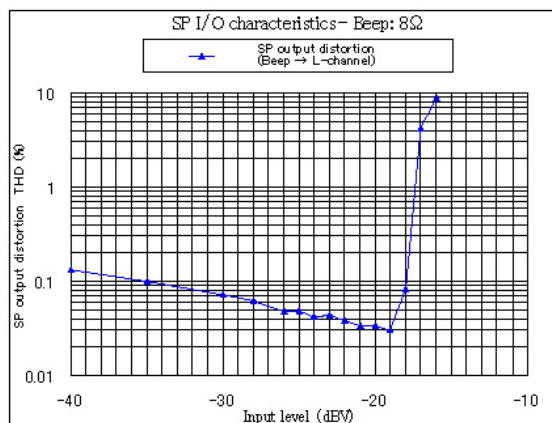
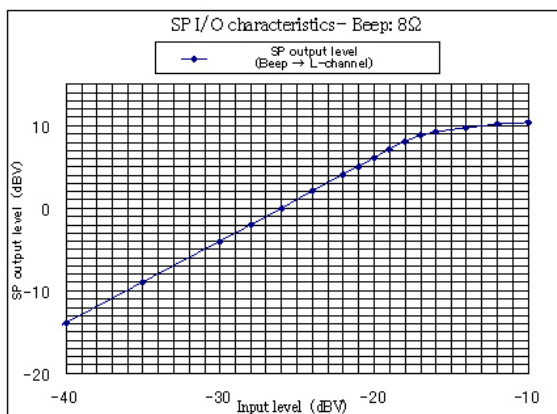
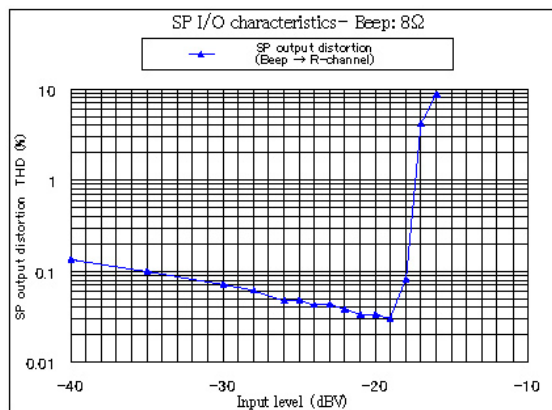
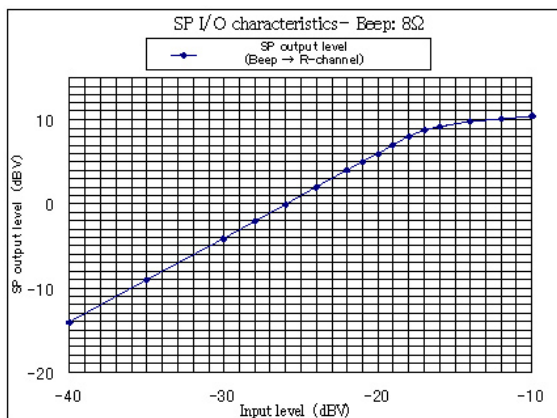

■ Application Notes (continued)

• Main characteristics (continued)

1) I/O characteristics, frequency characteristics (continued)

(3) SP frequency level, distortion characteristics (R-channel, L-channel)

AGC = Off, Automatic detection = On, SP gain setting = High, $V_{CC} = 3.3\text{ V}$, $V_{CC_SP} = 5.0\text{ V}$,

Input level = -22 dBV

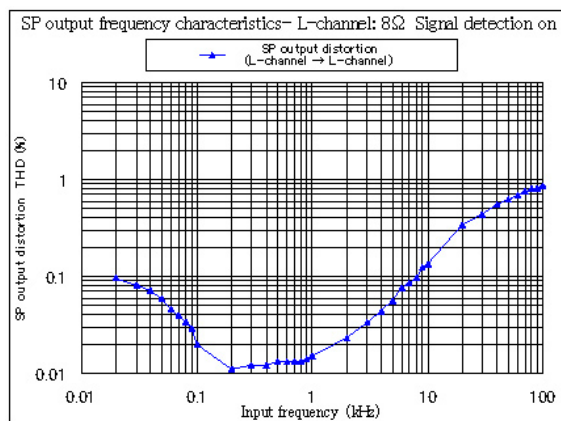
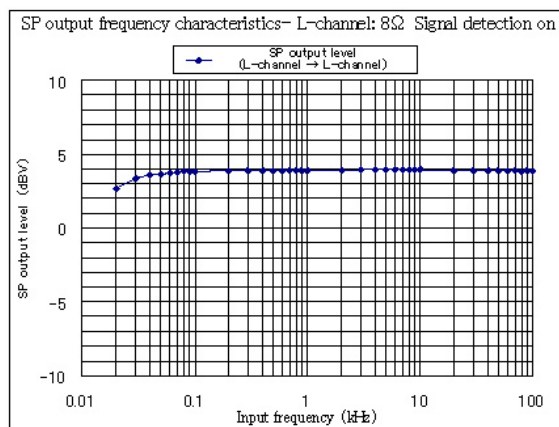
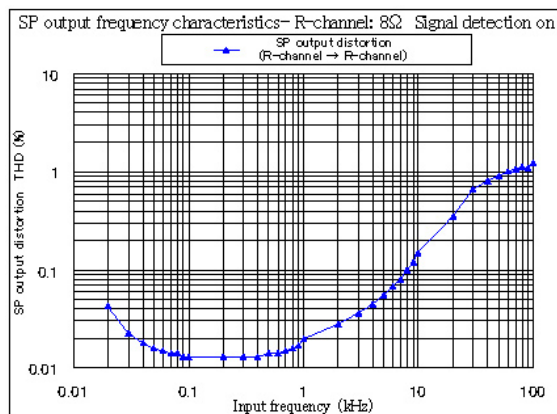
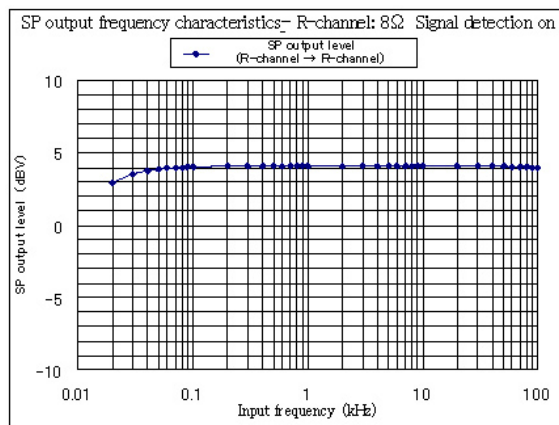

■ Application Notes (continued)

• Main characteristics (continued)

1) I/O characteristics, frequency characteristics (continued)

(3) SP frequency level, distortion characteristics (R-channel, L-channel) (continued)

AGC = Off, Automatic detection = On, SP gain setting = Low, $V_{CC} = 5.0\text{ V}$, $V_{CC_SP} = 5.0\text{ V}$,
 Input level = -16 dBV

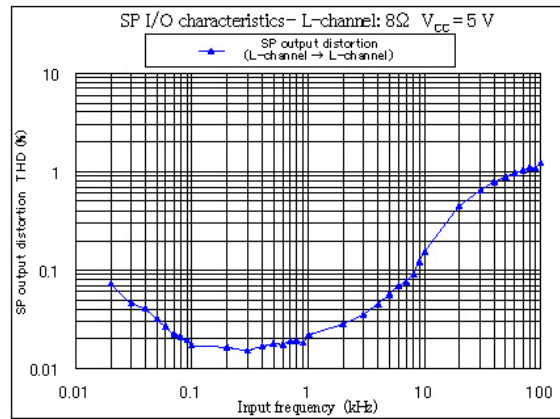
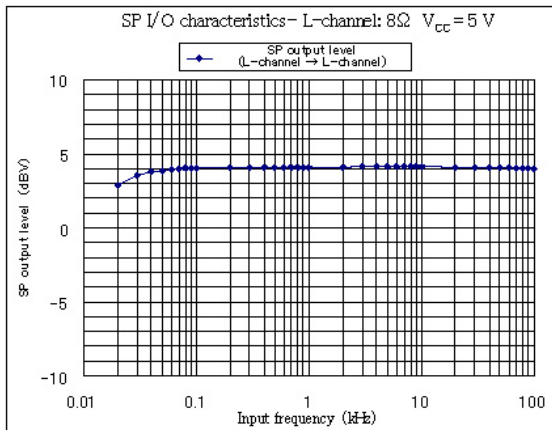
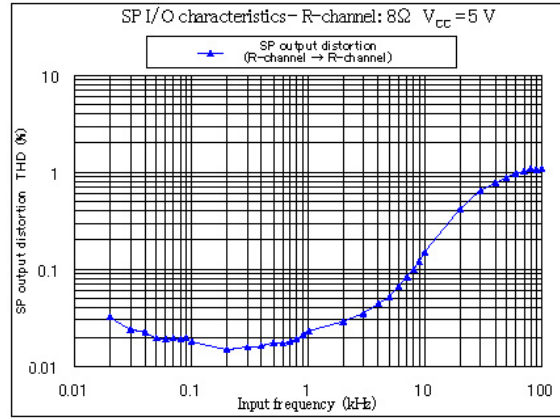
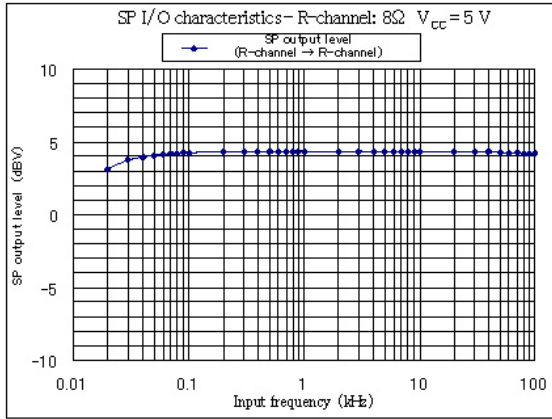

■ Application Notes (continued)

• Main characteristics (continued)

1) I/O characteristics, frequency characteristics (continued)

(4) SP frequency level, distortion characteristics (Beep)

AGC = Off, Automatic detection = Off, SP gain setting = High, $V_{CC} = 3.3\text{ V}$, $V_{CC_SP} = 5.0\text{ V}$,

Input level = -22 dBV

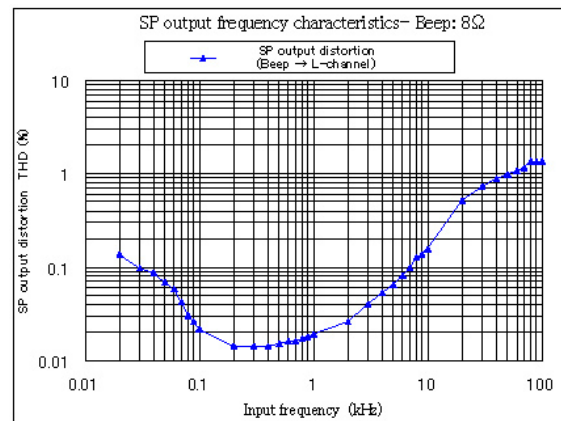
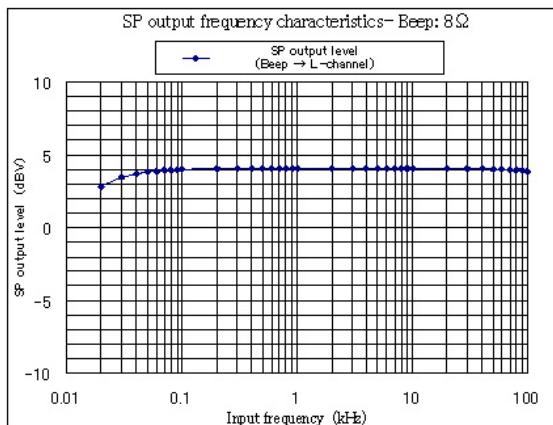
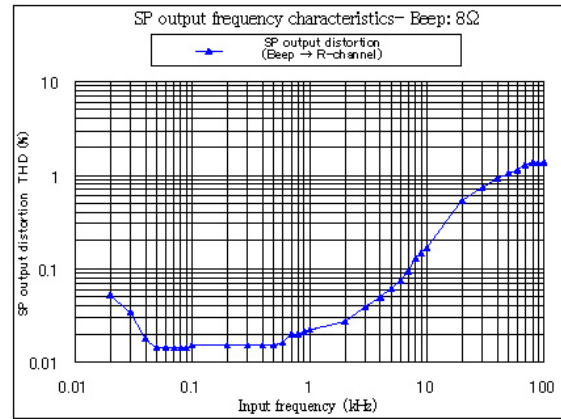
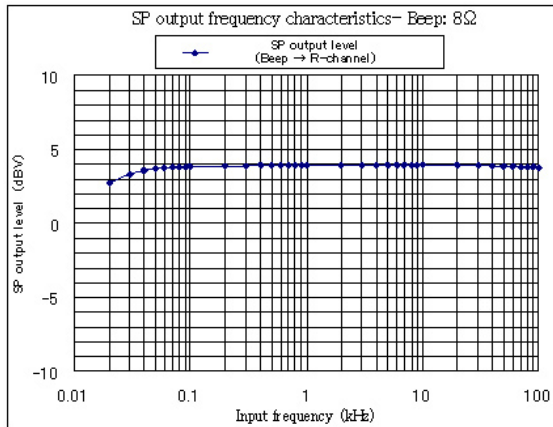

■ Application Notes (continued)

• Main characteristics (continued)

1) I/O characteristics, frequency characteristics (continued)

(5) SP – AGC I/O level, distortion characteristics (R-channel, L-channel)

AGC = On, Automatic detection = On, $V_{CC} = 3.3\text{ V}$, $V_{CC_SP} = 5.0\text{ V}$,
 Input frequency = 1 kHz, R-out = 8 Ω , HPF: 400 Hz, LPF: 30 kHz

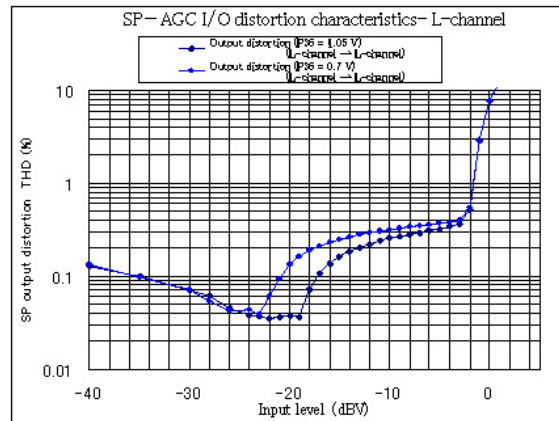
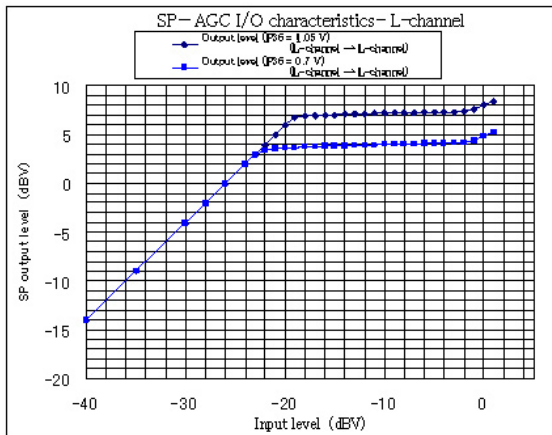
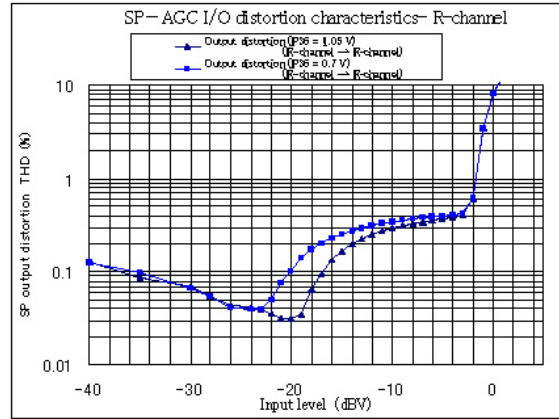
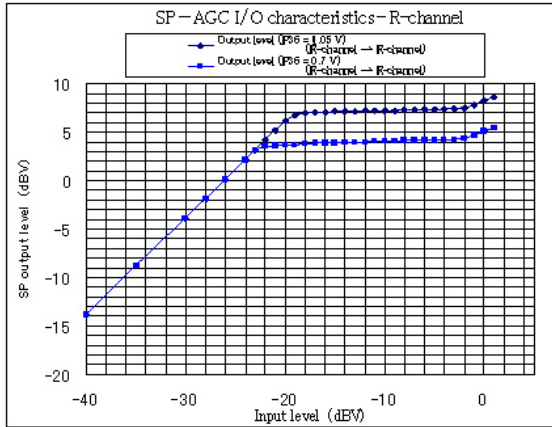

■ Application Notes (continued)

• Main characteristics (continued)

1) I/O characteristics, frequency characteristics (continued)

(6) SP – AGC frequency level, distortion characteristics (R-channel, L-channel)

AGC = On, Automatic detection = On, $V_{CC} = 3.3\text{ V}$, $V_{CC_SP} = 5.0\text{ V}$,

Input frequency = 1 kHz, R-out = 8 Ω , HPF: 400 Hz, LPF: 30 kHz

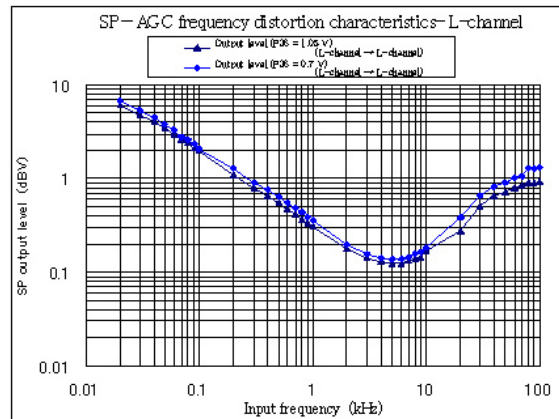
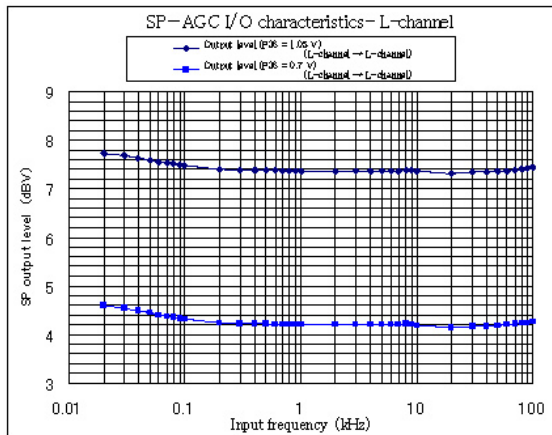
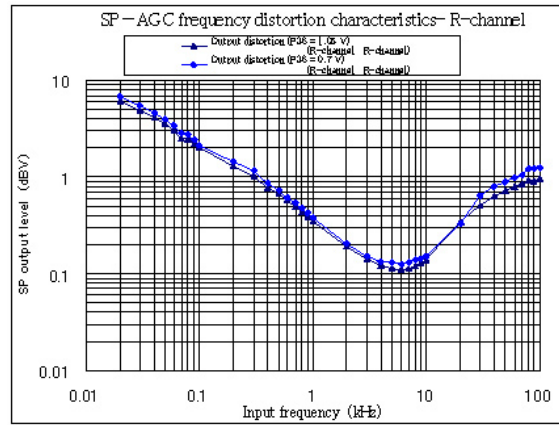
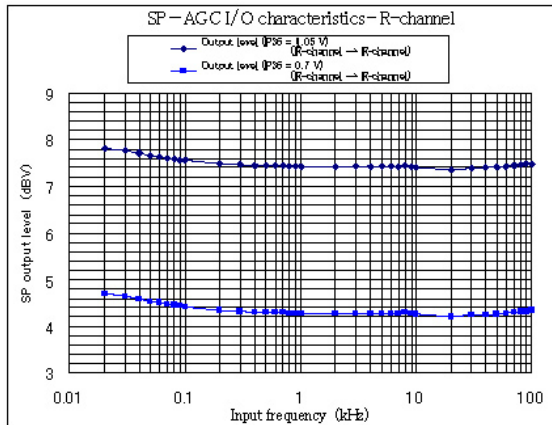

■ Application Notes (continued)

• Main characteristics (continued)

1) I/O characteristics, frequency characteristics (continued)

(7) Mix amplifier I/O level, distortion characteristics (R-channel, L-channel)

AGC = Off, Automatic detection = Off, SP power save, $V_{CC} = 3.3\text{ V}$, $V_{CC_SP} = 5.0\text{ V}$,

Input frequency = 1 kHz, HPF: 400 Hz, LPF: 30 kHz

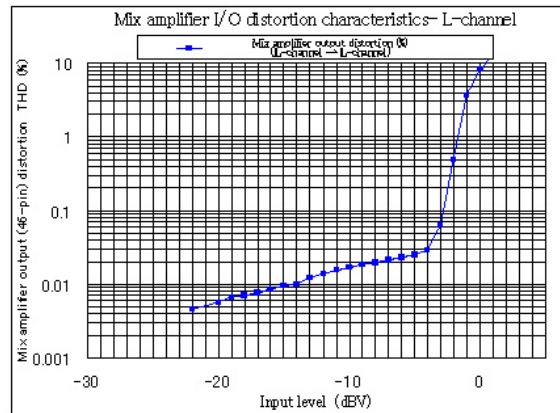
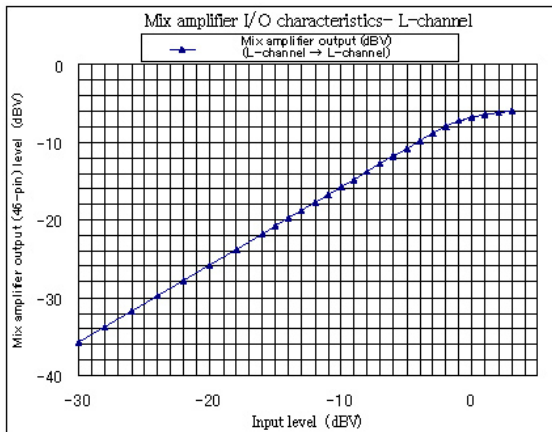
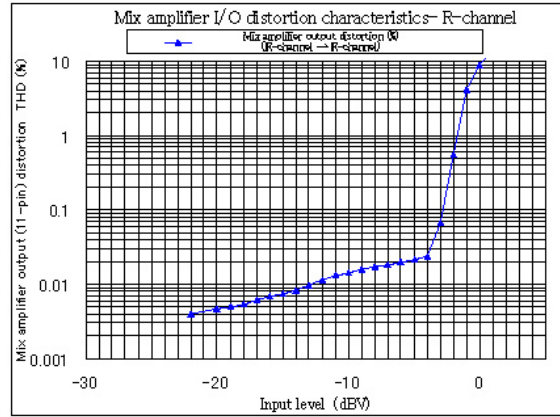
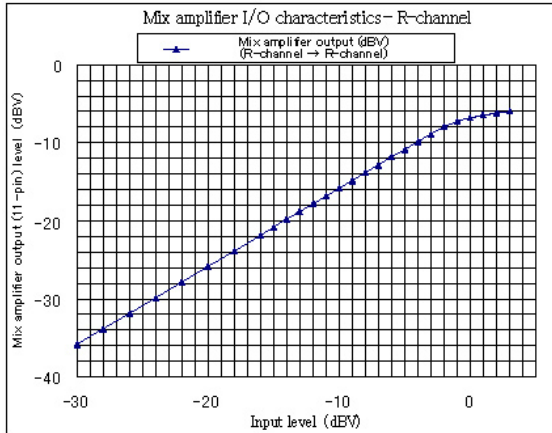

■ Application Notes (continued)

• Main characteristics (continued)

1) I/O characteristics, frequency characteristics (continued)

(8) Mix amplifier frequency level, distortion characteristics (R-channel, L-channel)

AGC = Off, Automatic detection = Off, SP power save, $V_{CC} = 5.0\text{ V}$, $V_{CC_SP} = 5.0\text{ V}$,

Input level = -10 dBV

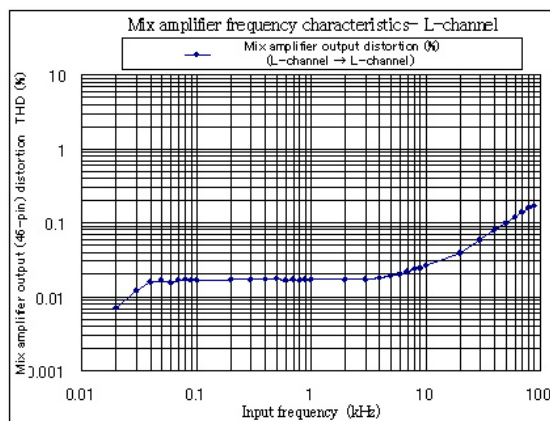
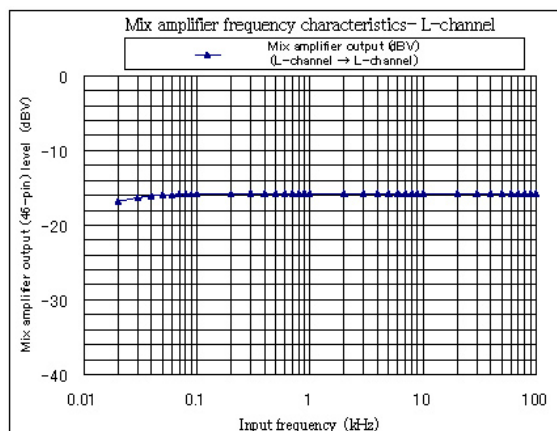
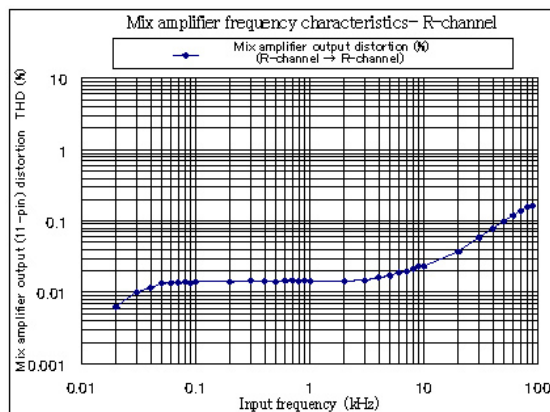
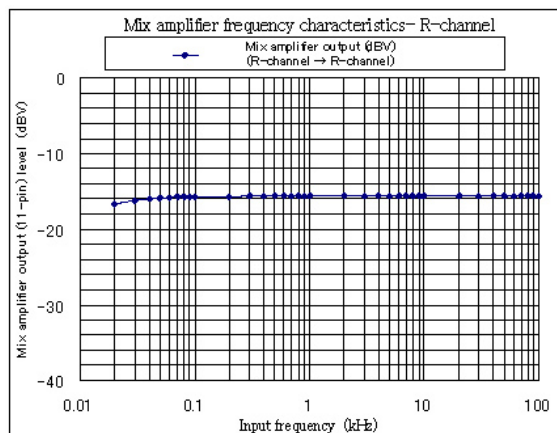

■ Application Notes (continued)

• Main characteristics (continued)

2) V_{CC} , temperature variation characteristics

(1) SP output level, distortion characteristics (R-channel, L-channel)

AGC = Off, Automatic detection = Off, SP gain setting = High, $V_{CC_SP} = 5.0\text{ V}$, $V_{in} = -22\text{ dBV}$

Input frequency = 1 kHz, $R_L = 8\ \Omega$, HPF: 400 Hz, LPF: 30 kHz

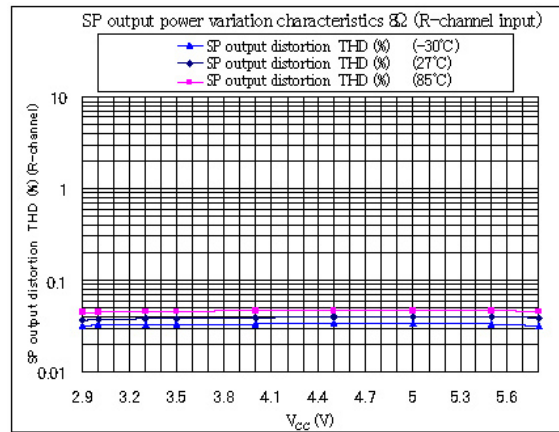
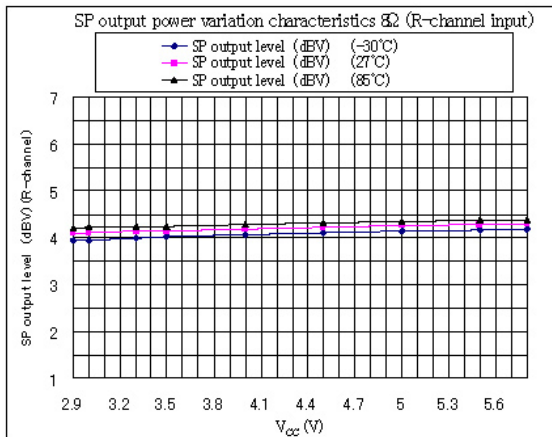
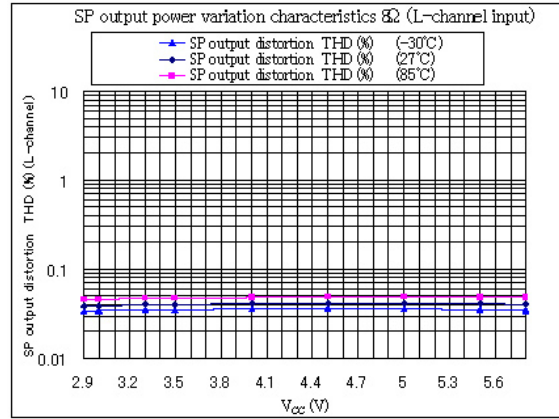
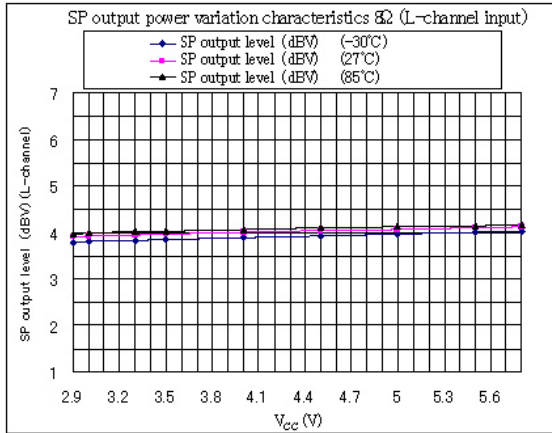

■ Application Notes (continued)

• Main characteristics (continued)

2) V_{CC} , temperature variation characteristics (continued)

(1) SP output level, distortion characteristics (R-channel, L-channel) (continued)

AGC = Off, Automatic detection = Off, SP gain setting = High, $V_{CC_SP} = 5.0$ V, $V_{in} = -22$ dBV

Input frequency = 1 kHz, $R_L = 4 \Omega$, HPF: 400 Hz, LPF: 30 kHz

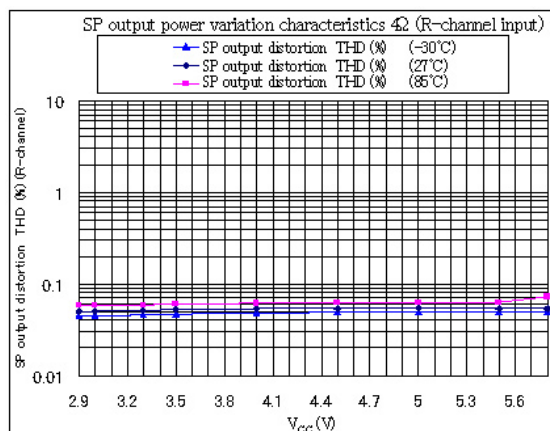
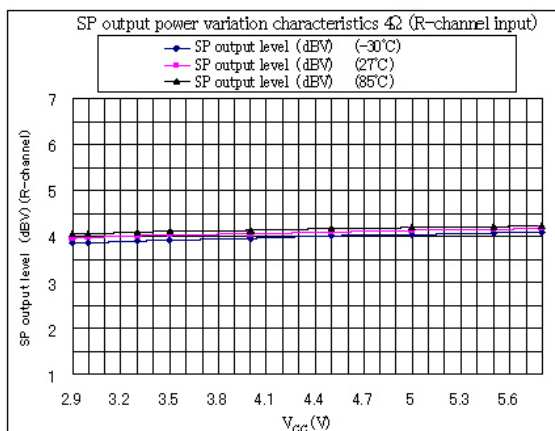
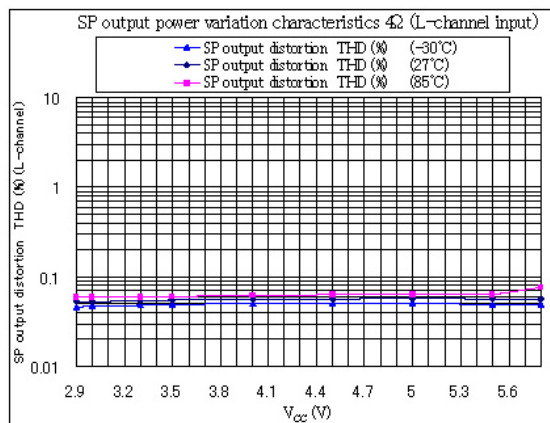
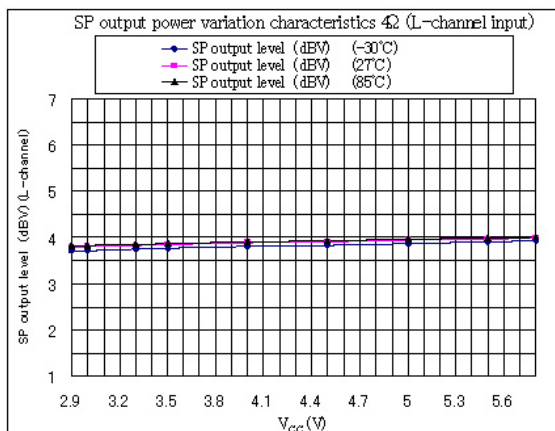

■ Application Notes (continued)

• Main characteristics (continued)

2) V_{CC} , temperature variation characteristics (continued)

(2) SP maximum output level characteristics (R-channel, L-channel)

AGC = Off, Automatic detection = Off, SP gain setting = High, $V_{CC_SP} = 5.0\text{ V}$

Input frequency = 1 kHz, $R_L = 8\ \Omega$, HPF: 400 Hz, LPF: 30 kHz

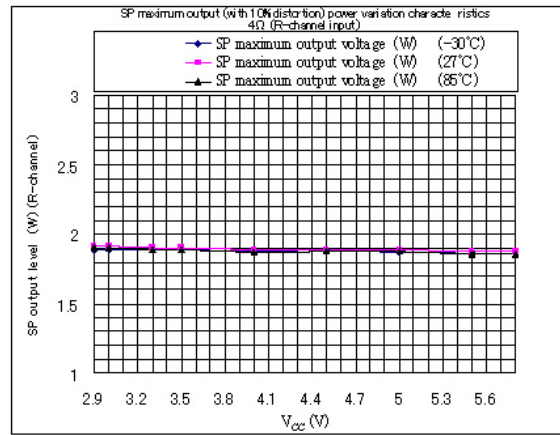
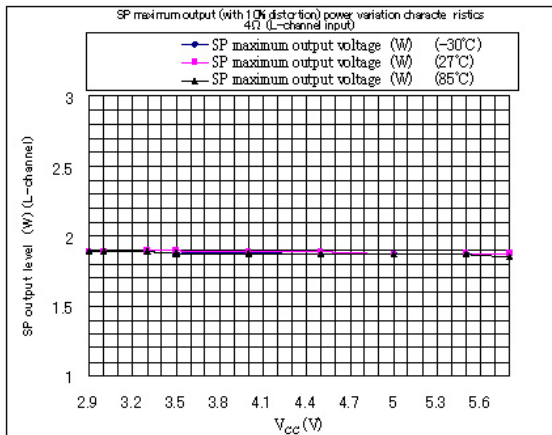
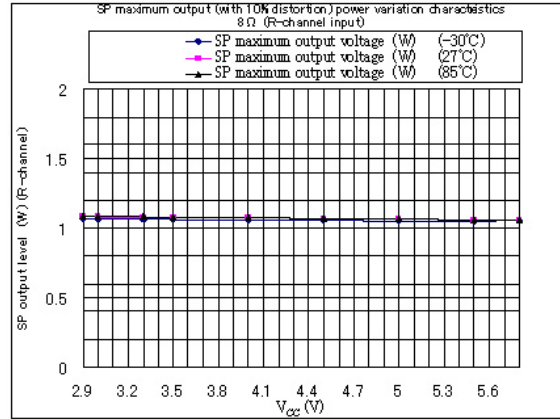
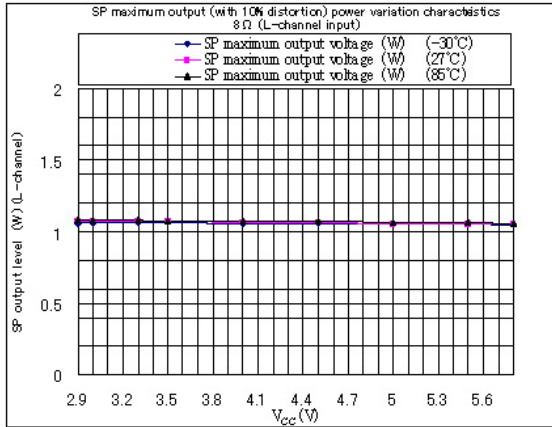

■ Application Notes (continued)

• Main characteristics (continued)

2) V_{CC} , temperature variation characteristics (continued)

(3) SP – AGC output level characteristics (R-channel, L-channel)

AGC = On, Automatic detection = Off, SP gain setting = High, $V_{CC_SP} = 5.0$ V, P36 = 1.05 V

$V_{in} = -6$ dBV, Input frequency = 1 kHz, $R_L = 8 \Omega$, HPF: 400 Hz, LPF: 30 kHz

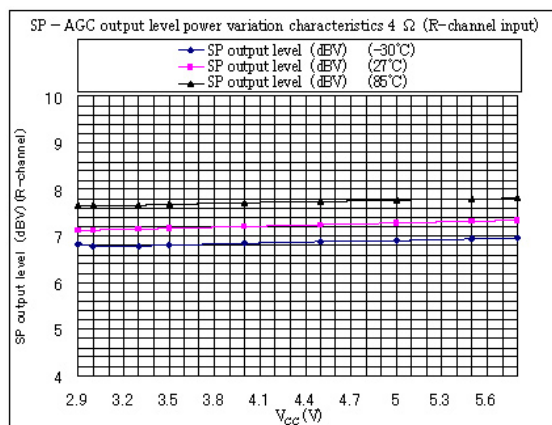
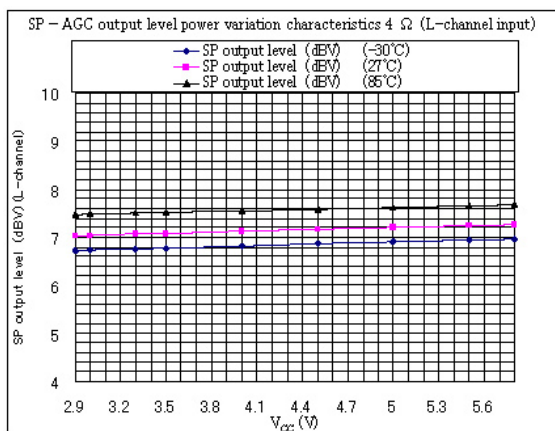
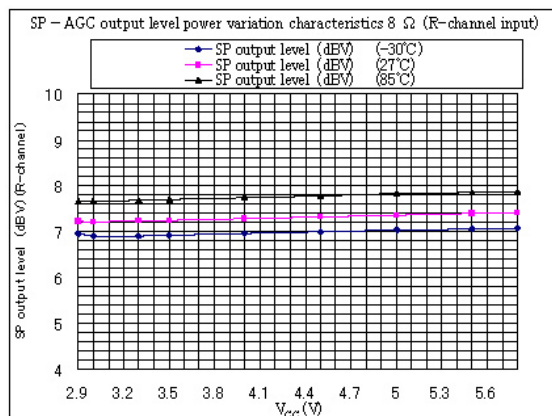
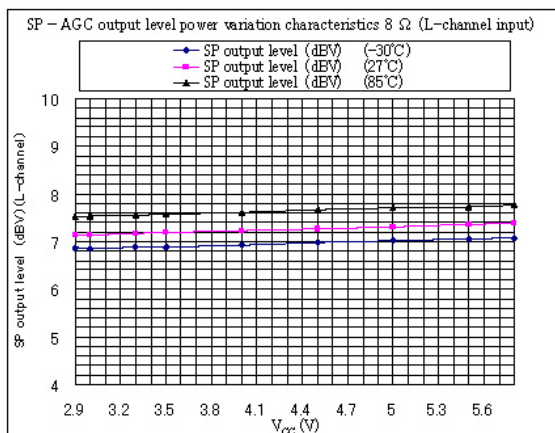

■ Application Notes (continued)

• Main characteristics (continued)

2) V_{CC} , temperature variation characteristics (continued)

(4) Mix amplifier output level, distortion characteristics (R-channel, L-channel)

AGC = Off, Automatic detection = Off, SP power save, $V_{CC_SP} = 5.0$ V

$V_{in} = -10$ dBV, Input frequency = 1 kHz, HPF: 400 Hz, LPF: 30 kHz

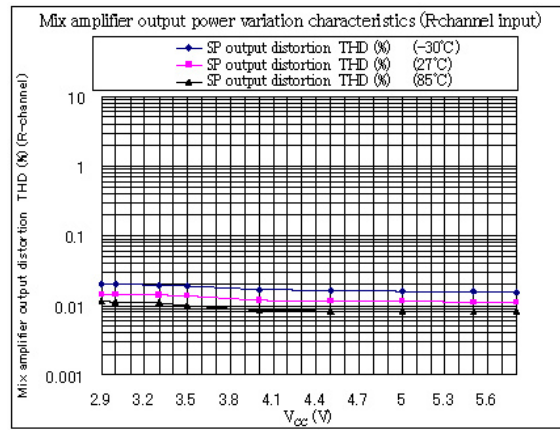
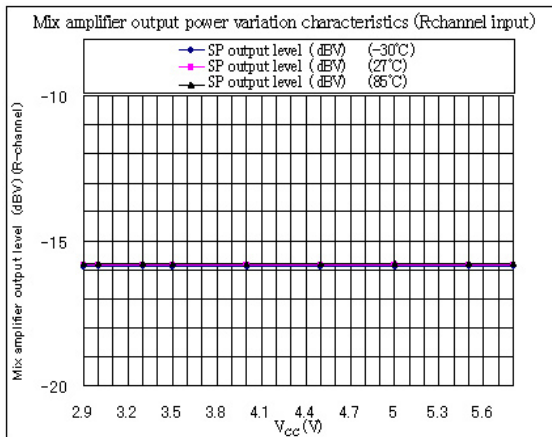
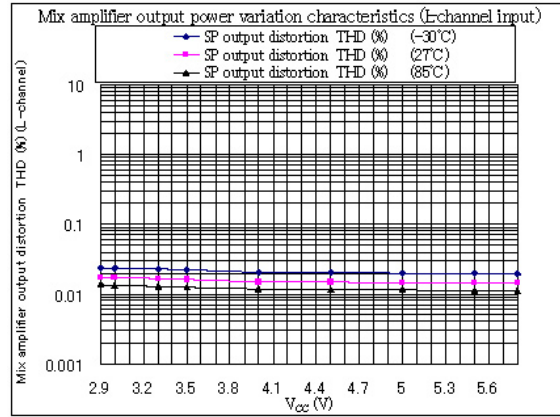
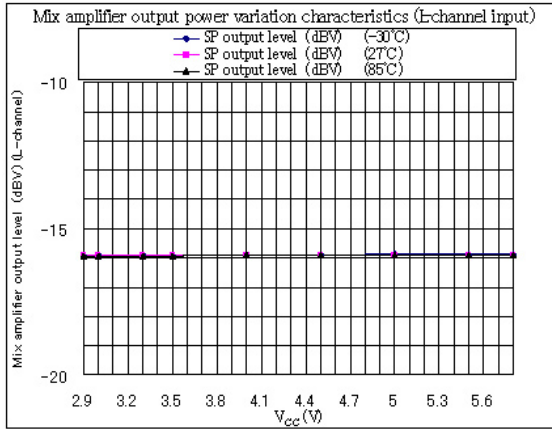

■ Application Notes (continued)

• Main characteristics (continued)

2) V_{CC} , temperature variation characteristics (continued)

(5) Signal detection threshold value (R-channel, L-channel)

AGC = Off, Automatic detection = On, $V_{CC_SP} = 5.0$ V

Input frequency = 1 kHz, HPF: 400 Hz, LPF: 30 kHz

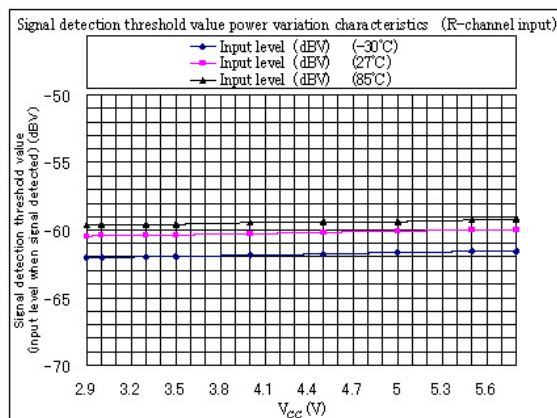
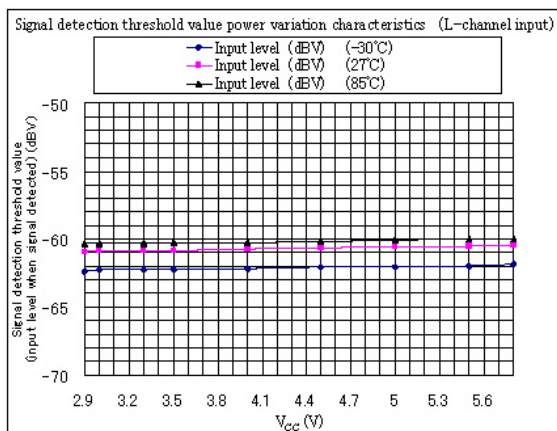

Request for your special attention and precautions in using the technical information and semiconductors described in this material

- (1) An export permit needs to be obtained from the competent authorities of the Japanese Government if any of the products or technical information described in this material and controlled under the "Foreign Exchange and Foreign Trade Law" is to be exported or taken out of Japan.
- (2) The technical information described in this material is limited to showing representative characteristics and applied circuits examples of the products. It neither warrants non-infringement of intellectual property right or any other rights owned by our company or a third party, nor grants any license.
- (3) We are not liable for the infringement of rights owned by a third party arising out of the use of the technical information as described in this material.
- (4) The products described in this material are intended to be used for standard applications or general electronic equipment (such as office equipment, communications equipment, measuring instruments and household appliances).
Consult our sales staff in advance for information on the following applications:
 - Special applications (such as for airplanes, aerospace, automobiles, traffic control equipment, combustion equipment, life support systems and safety devices) in which exceptional quality and reliability are required, or if the failure or malfunction of the products may directly jeopardize life or harm the human body.
 - Any applications other than the standard applications intended.
- (5) The products and product specifications described in this material are subject to change without notice for modification and/or improvement. At the final stage of your design, purchasing, or use of the products, therefore, ask for the most up-to-date Product Standards in advance to make sure that the latest specifications satisfy your requirements.
- (6) When designing your equipment, comply with the guaranteed values, in particular those of maximum rating, the range of operating power supply voltage, and heat radiation characteristics. Otherwise, we will not be liable for any defect which may arise later in your equipment.
Even when the products are used within the guaranteed values, take into the consideration of incidence of break down and failure mode, possible to occur to semiconductor products. Measures on the systems such as redundant design, arresting the spread of fire or preventing glitch are recommended in order to prevent physical injury, fire, social damages, for example, by using the products.
- (7) When using products for which damp-proof packing is required, observe the conditions (including shelf life and amount of time let standing of unsealed items) agreed upon when specification sheets are individually exchanged.
- (8) This material may be not reprinted or reproduced whether wholly or partially, without the prior written permission of Matsushita Electric Industrial Co., Ltd.