

## 1270 nm ~ 1610 nm DFB LASER DIODES CWDM MQW-DFB LASER DIODES

## DL-5100-CXX0 SERIES

### FEATURES

- 2 18-wavelength CWDM: from 1270 nm to 1610 nm, each Step 20 nm
- 2 High reliability, long operation life
- 2 0 °C ~+70 °C operation
- 2 Single frequency operation with high SMSR
- 2 Up to 2.5 Gb/s Operation
- 2 Build-in InGaAs monitor
- 2 Flat Window Cap Package (DL-510XX-CXX0)
- 2 Aspherical Lens Cap Package (DL-512XX-CXX0)
- 2 2 mm Ball Lens Cap Package (DL-514XX-CXX0)

### APPLICATION

Optical communication system

### DESCRIPTION

DL-5100-CXX0 series are CWDM MQW-DFB laser diodes that provide a durable, single frequency oscillation with emission wavelength from 1270 nm to 1610 nm, each step 20 nm.

<b>ELECTRICAL AND OPTICAL CHARACTERISTICS (Tc=25°C, Pop=5mW, unless otherwise specified)</b>						
Symbol	Parameter	Test Conditions	Min.	Typ.	Max.	Unit
I <sub>th</sub>	Threshold Current	CW		10	15	mA
I <sub>OP</sub>	Operating Current	CW, Pop=5mW		35	50	mA
V <sub>OP</sub>	Operating Voltage	CW, Pop=5mW		1.2	1.5	V
η	Slope Efficiency Part No:DL-510XX-CXX0 DL-512XX-CXX0 DL-514XX-CXX0	CW, Pop=5mW	0.15 0.18 0.15	0.25 0.22 0.22		mW/mA
λ c	Center Wavelength	CW, Pop=5mW	λ -3	λ	λ +2	nm
SMSR	Side Mode Suppression Ratio	CW, Pop=5mW	30	35		dB
θ //	Beam Divergence (Parallel)	CW, Flat Window		25		deg.
θ ⊥	Beam Divergence (Perpendicular)	CW, Flat Window		35		deg.
t <sub>r</sub> , t <sub>f</sub>	Rise And Fall Times Part No: DL-510XX-CXX0 DL-510XXS-CXX0	CW, Pop=5mW			226 150	ps
I <sub>m</sub>	PD Monitor Current	I <sub>F</sub> =I <sub>th</sub> , 20~ 80%, Pop=5mW	50		1500	μA
I <sub>D</sub>	PD Dark Current	CW, V <sub>RD</sub> =1V			10	nA
C <sub>t</sub>	PD Capacitance	V <sub>RD</sub> =5V		10	15	pF
P <sub>f</sub>	Fiber Coupled Power Part No: DL-512XX-CXX0 DL-514XX-CXX0	V <sub>RD</sub> =5V, f=1MHz, Pop=5mW	1.5 0.5			mW

Note: Central CWDM wavelength is from 1270 nm to 1610 nm, each step 20 nm.

\*\*\*\*\*

ABSOLUTE MAXIMUM RATINGS (T <sub>C</sub> =25 °C)			
Symbol	Parameter	Ratings	Unit
P <sub>o</sub>	Optical Output Power	6	mW
V <sub>RL</sub>	LD Reverse Voltage	2	V
V <sub>RD</sub>	PD Reverse Voltage	15	V
I <sub>FD</sub>	PD Forward Current	2	mA
T <sub>opr</sub>	Operating Temperature	0 ~ 70	°C
T <sub>stg</sub>	Storage Temperature	-40 ~ +85	°C

## MECHANICAL DIMENSION (mm) and PIN ASSIGNMENT

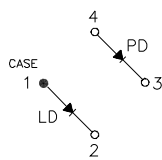

Type A

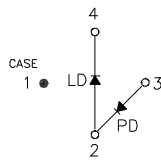

Type B

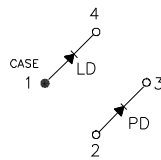

Type C

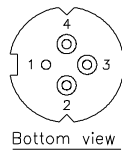
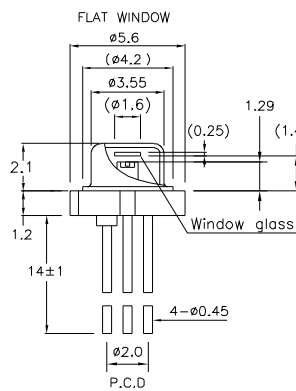

**DL-510XX-CXX0**

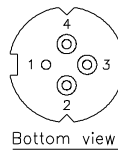
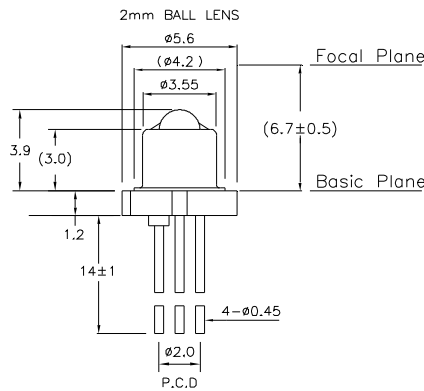

**DL-514XX-CXX0**

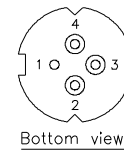
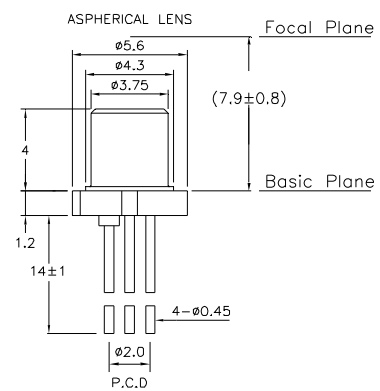

**DL-512XX-CXX0**

**Note:** Specifications subject to change without notice.

ORDER INFORMATION

Part No.: D L - 5 1    - C   0

Code	Cap Type
0	Flat Window
2	Aspherical Lens
4	2 mm Ball Lens

Code	Pin Assignment
0	Type A
5	Type B
8	Type C

Code	Speed
Blank	1.25 Gbps
S	2.5 Gbps

Code	Wavelegnth
27	1270 nm
29	1290 nm
31	1310 nm
33	1330 nm
35	1350 nm
37	1370 nm
39	1390 nm
41	1410 nm
43	1430 nm

Code	Wavelegnth
45	1450 nm
47	1470 nm
49	1490 nm
51	1510 nm
53	1530 nm
55	1550 nm
57	1570 nm
59	1590 nm
61	1610 nm

Revision History

Version	Subject	Release Date
1.0	Initial datasheet	2003/10/1
2.0	Combine 1.25G and 2.5G characteristics in one data sheet	2007/12/1