BB403M

Build in Biasing Circuit MOS FET IC
VHF/UHF RF Amplifier

HITACHI

ADE-208-699A (Z)
2nd. Edition
Nov. 1998

Features

- Build in Biasing Circuit; To reduce using parts cost & PC board space.
- High forward transfer admittance;
($|y_{fs}| = 42 \text{ mS typ. at } f = 1 \text{ kHz}$)
- Withstanding to ESD;
Build in ESD absorbing diode. Withstand up to 250V at $C=200\text{pF}$, $R_s=0$ conditions.
- Provide mini mold packages; MPAK-4R (SOT-143 var.)

Outline

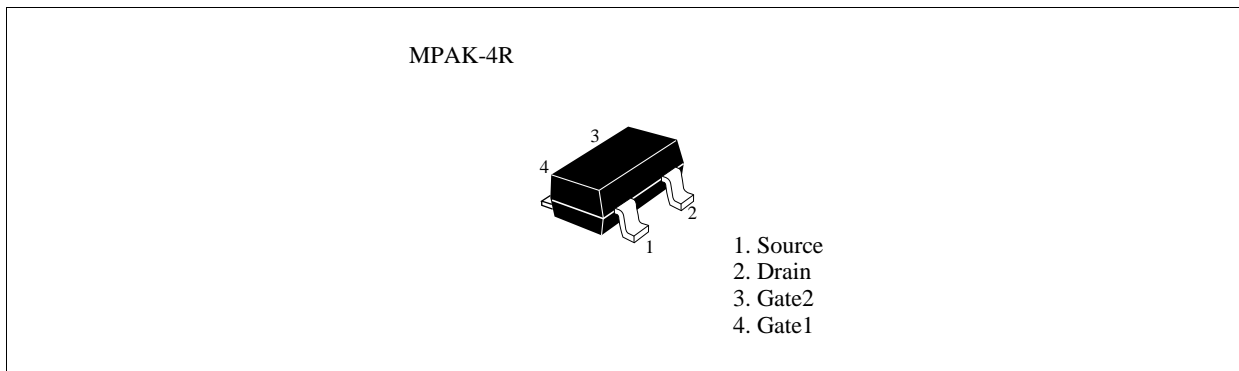

Notes: 1. Marking is "CX-".

2. BB403M is individual type number of HITACHI BBFET.

BB403M

Absolute Maximum Ratings (Ta = 25°C)

Item	Symbol	Ratings	Unit
Drain to source voltage	V_{DS}	7	V
Gate1 to source voltage	V_{G1S}	- 0/ +7	V
Gate2 to source voltage	V_{G2S}	- 0/ +7	V
Drain current	I_D	25	mA
Channel power dissipation	Pch	150	mW
Channel temperature	Tch	150	°C
Storage temperature	Tstg	-55 to +150	°C

Electrical Characteristics (Ta = 25°C)

Item	Symbol	Min	Typ	Max	Unit	Test Conditions
Drain to source breakdown voltage	$V_{(BR)DSS}$	7	—	—	V	$I_D = 200\mu A$ $V_{G1S} = V_{G2S} = 0$
Gate1 to source breakdown voltage	$V_{(BR)G1SS}$	+7	—	—	V	$I_{G1} = +10\mu A$ $V_{G2S} = V_{DS} = 0$
Gate2 to source breakdown voltage	$V_{(BR)G2SS}$	+7	—	—	V	$I_{G2} = +10\mu A$ $V_{G1S} = V_{DS} = 0$
Gate1 to source cutoff current	I_{G1SS}	—	—	+100	nA	$V_{G1S} = +5V$ $V_{G2S} = V_{DS} = 0$
Gate2 to source cutoff current	I_{G2SS}	—	—	+100	nA	$V_{G2S} = +5V$ $V_{G1S} = V_{DS} = 0$
Gate1 to source cutoff voltage	$V_{G1S(off)}$	0.3	0.6	0.9	V	$V_{DS} = 5V, V_{G2S} = 4V$ $I_D = 100\mu A$
Gate2 to source cutoff voltage	$V_{G2S(off)}$	0.5	0.8	1.1	V	$V_{DS} = 5V, V_{G1S} = 5V$ $I_D = 100\mu A$
Drain current	$I_{D(op)}$	9	14	20	mA	$V_{DS} = 5V, V_{G1} = 5V$ $V_{G2S} = 4V, R_G = 470k\Omega$
Forward transfer admittance	$ y_{fs} $	35	42	50	mS	$V_{DS} = 5V, V_{G1} = 5V$ $V_{G2S} = 4V$ $R_G = 470k\Omega, f = 1kHz$
Input capacitance	c_{iss}	2.6	3.3	4.0	pF	$V_{DS} = 5V, V_{G1} = 5V$
Output capacitance	c_{oss}	1.7	2.1	2.5	pF	$V_{G2S} = 4V, R_G = 470k\Omega$
Reverse transfer capacitance	c_{rss}	—	0.025	0.05	pF	$f = 1MHz$
Power gain	PG1	28	32	—	dB	$V_{DS} = 5V, V_{G1} = 5V$ $V_{G2S} = 4V, R_G = 470k\Omega$
Noise figure	NF1	—	1.0	1.6	dB	$f = 200MHz$
Power gain	PG2	12	16.5	—	dB	$V_{DS} = 5V, V_{G1} = 5V$ $V_{G2S} = 4V, R_G = 470k\Omega$
Noise figure	NF2	—	2.85	3.7	dB	$f = 900MHz$

Main Characteristics

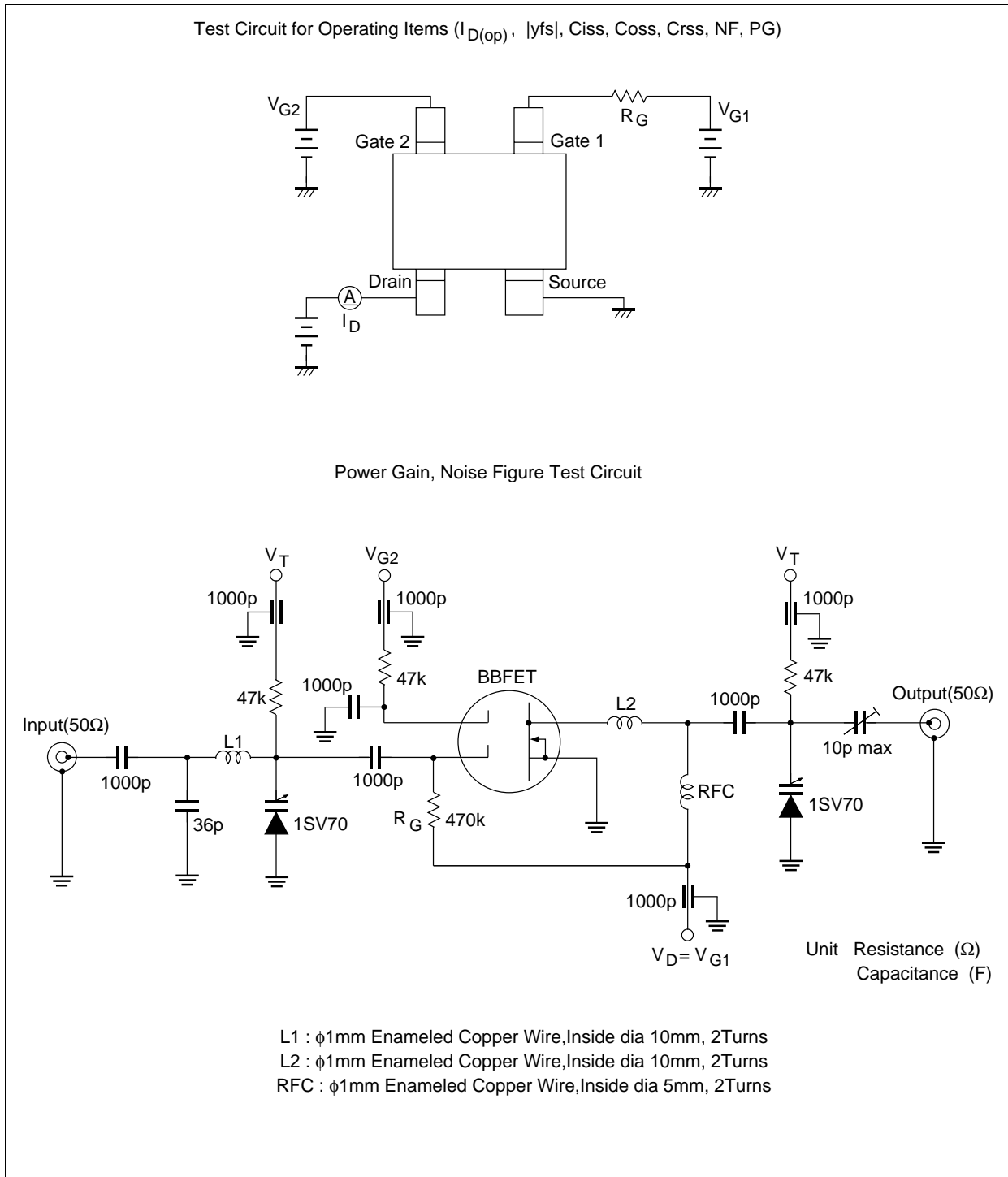

BB403M

900MHz Power Gain, Noise Test Circuit

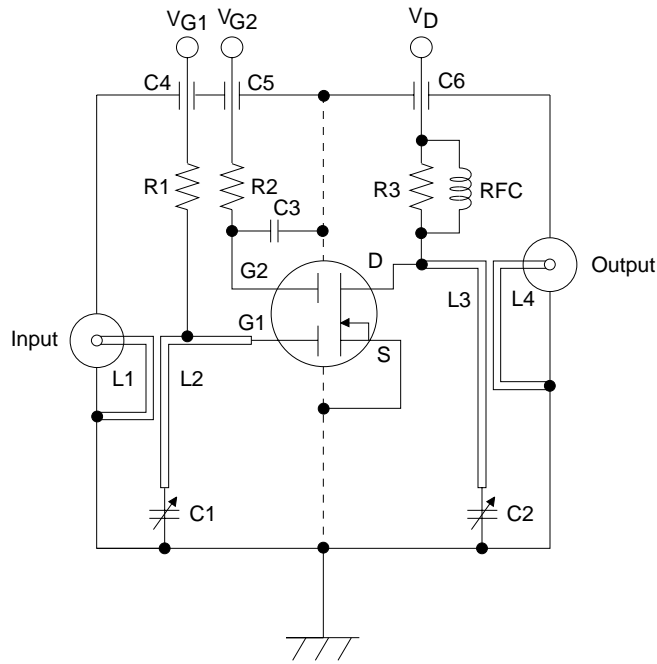

- C1, C2 : Variable Capacitor (10pF MAX)
- C3 : Disk Capacitor (1000pF)
- C4 to C6 : Air Capacitor (1000pF)
- R1 : 470 k Ω
- R2 : 47 k Ω
- R3 : 4.7 k Ω

L1:

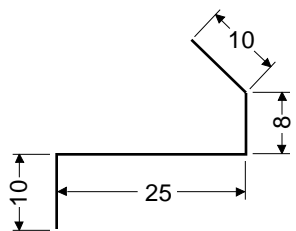

L2:

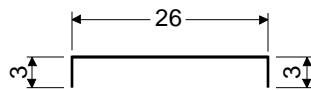

(ϕ 1mm Copper wire)
Unit : mm

L3:

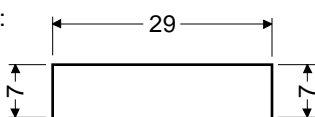

L4:

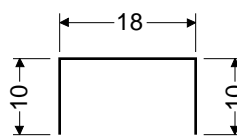

RFC : ϕ 1mm Copper wire with enamel 4turns inside dia 6mm

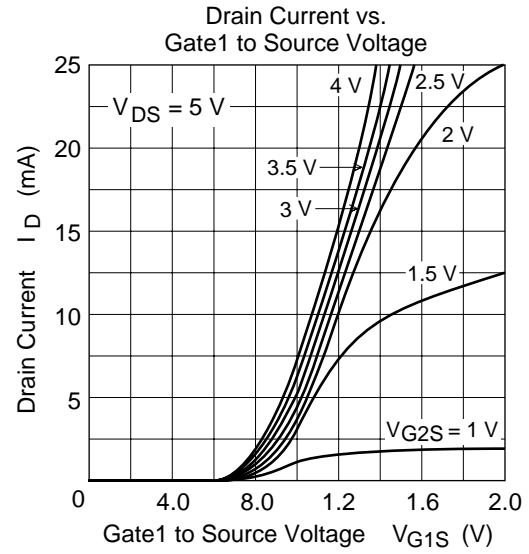
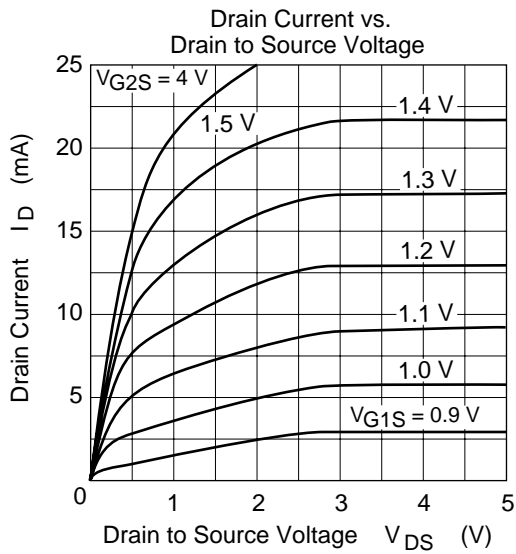
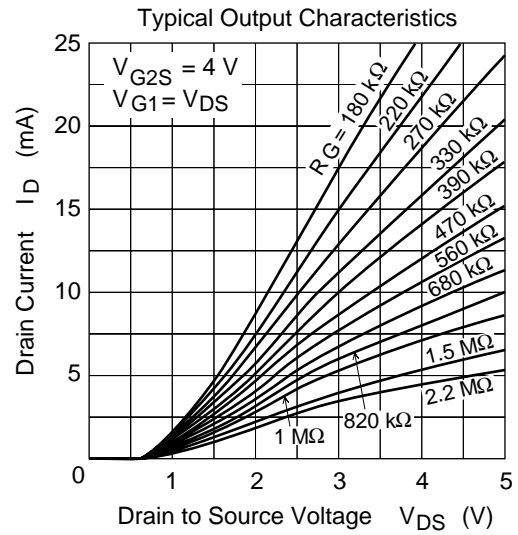
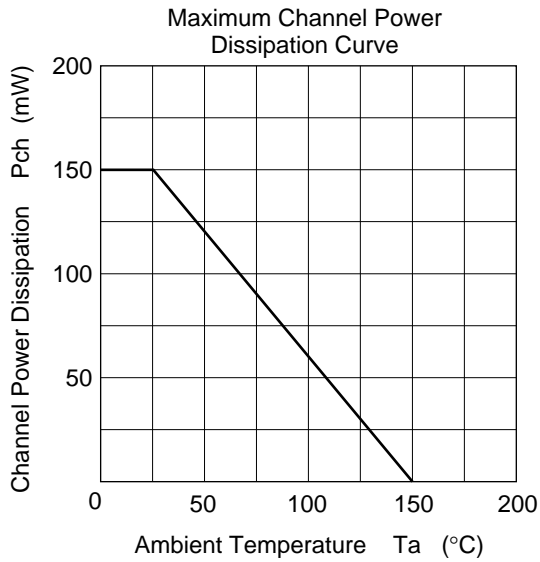

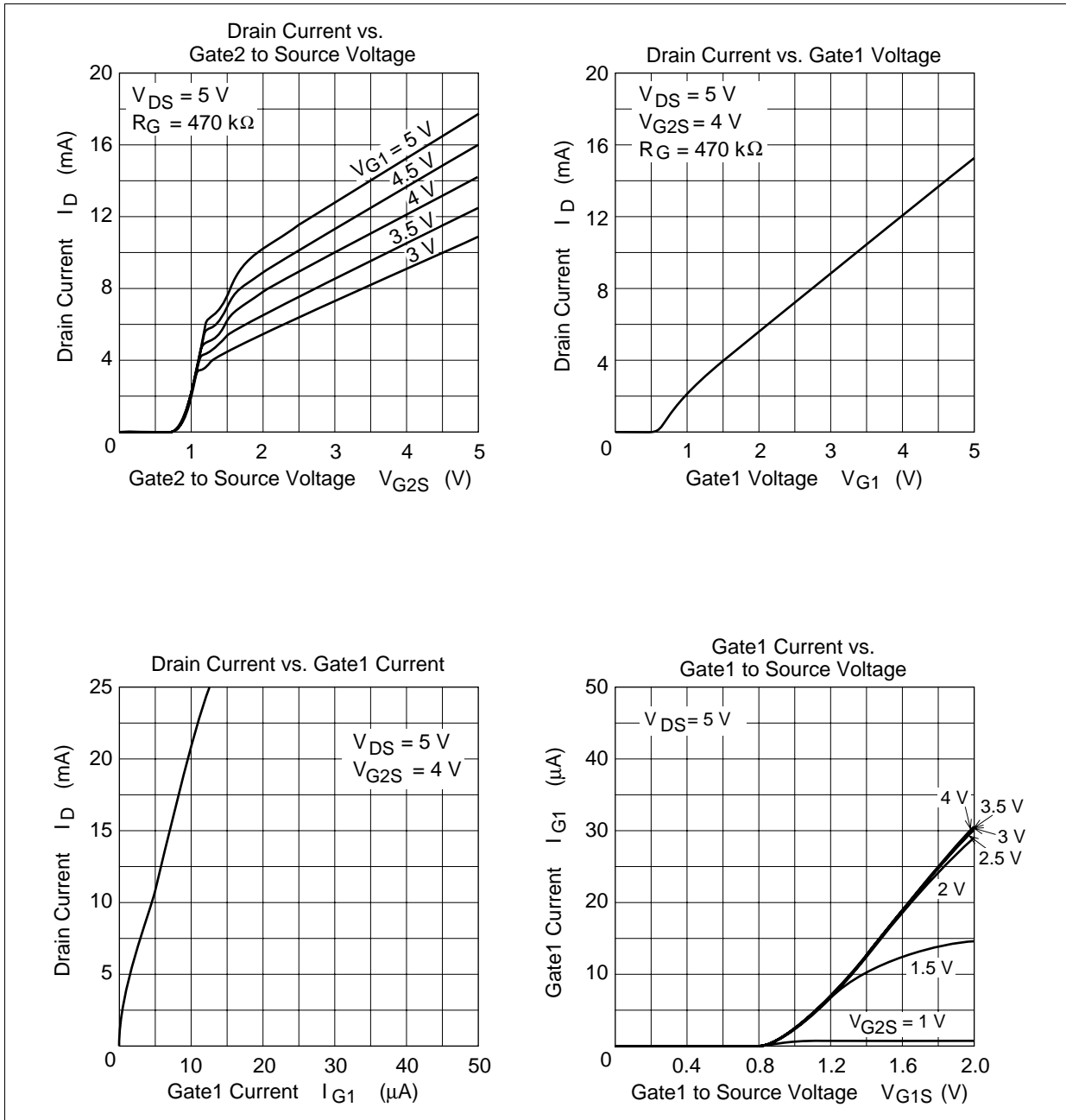

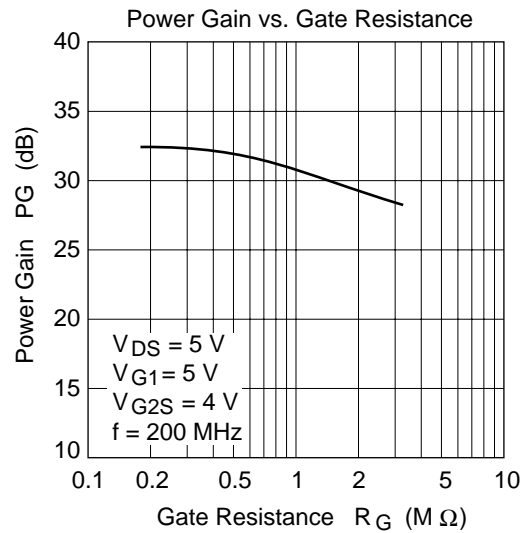
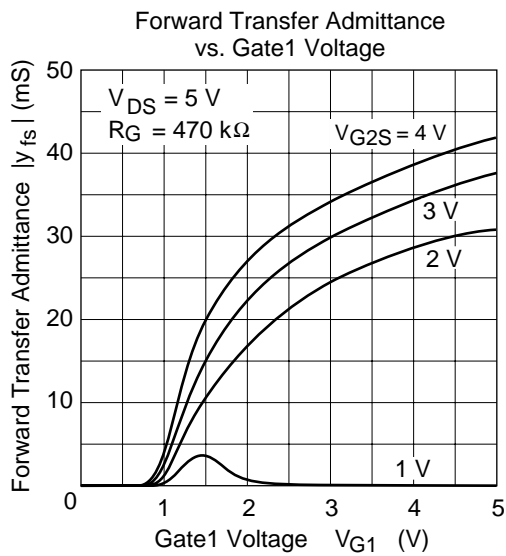
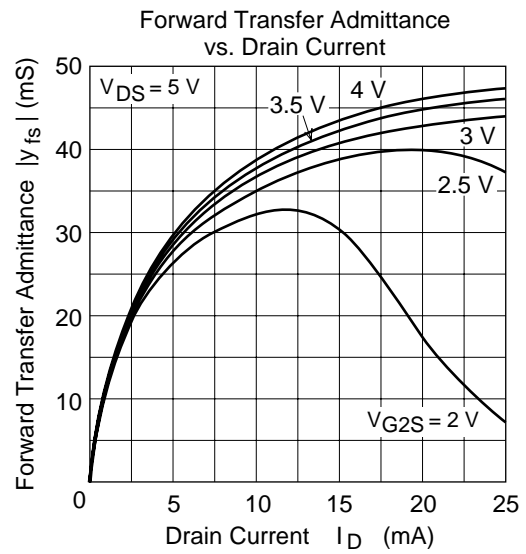
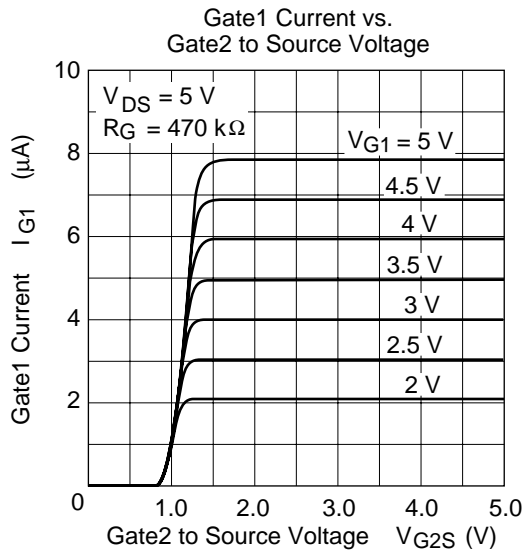

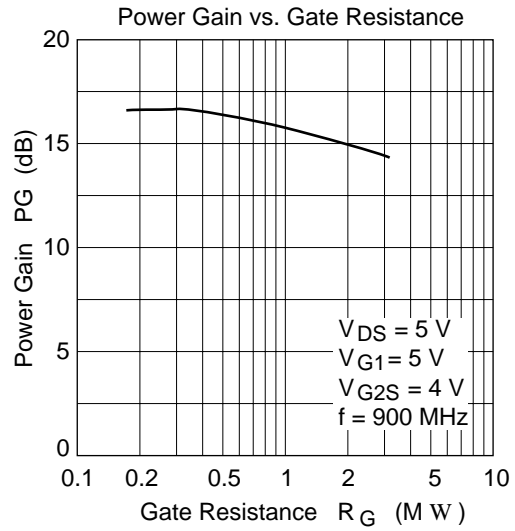
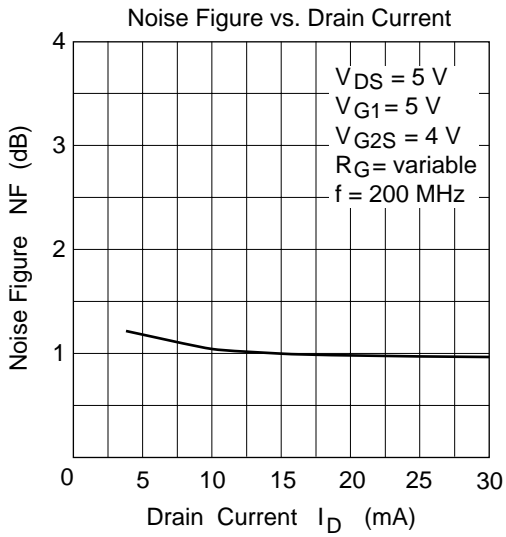
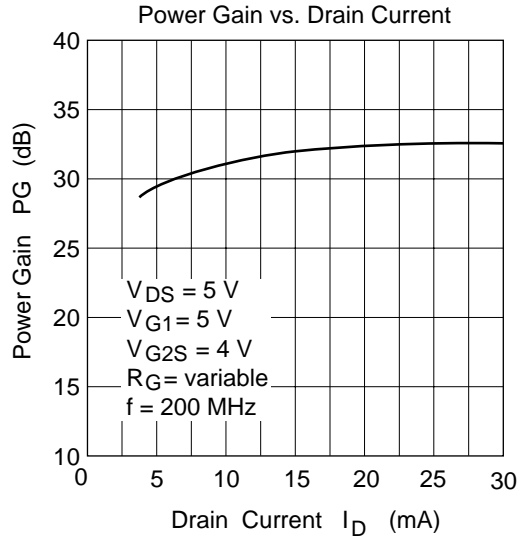
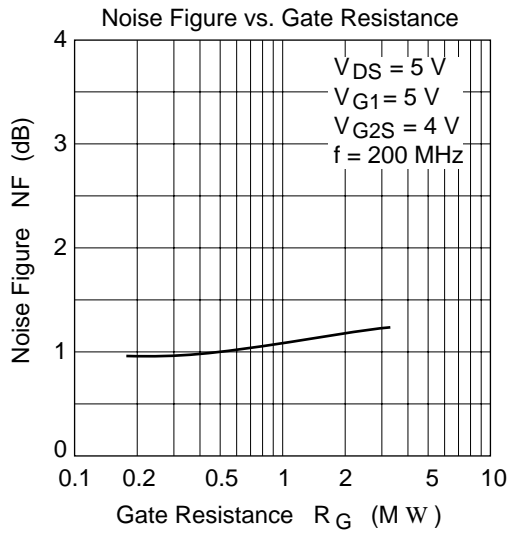

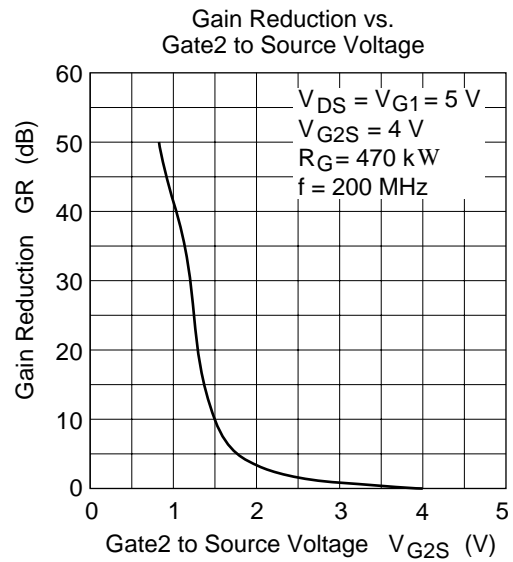
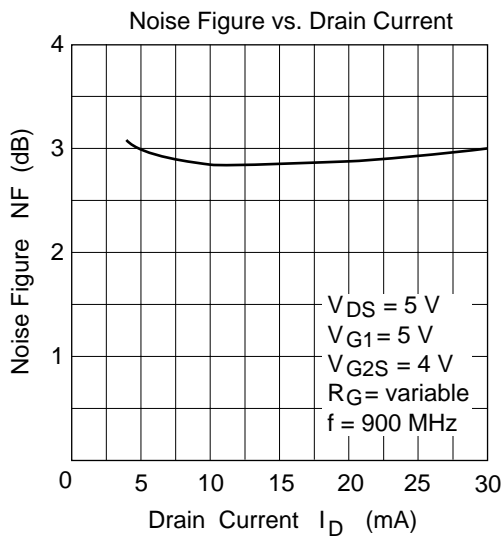
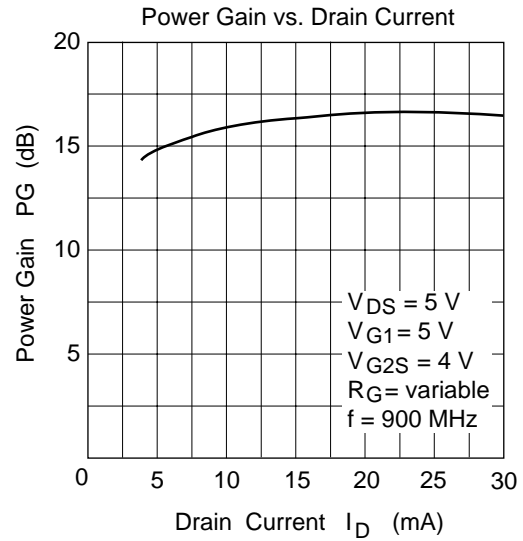
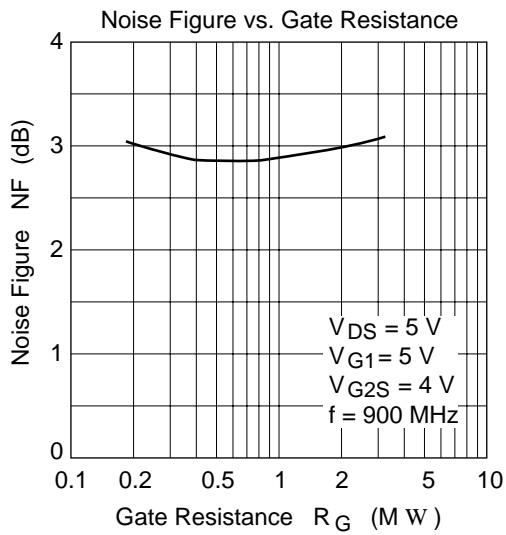

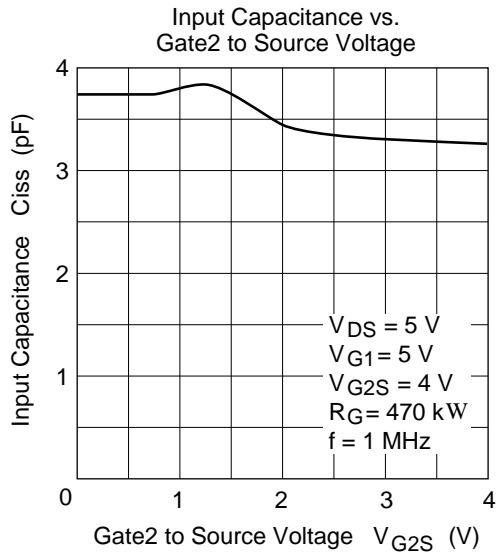
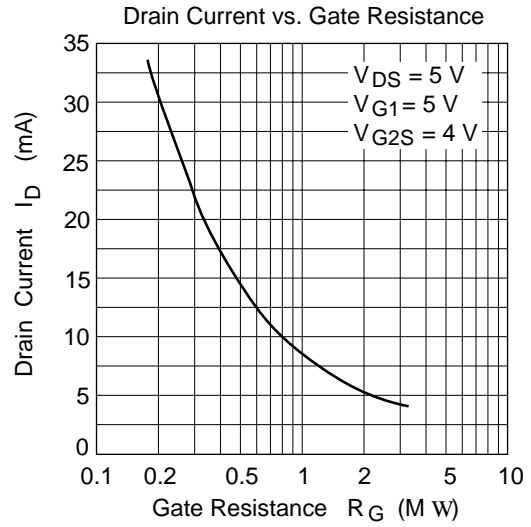
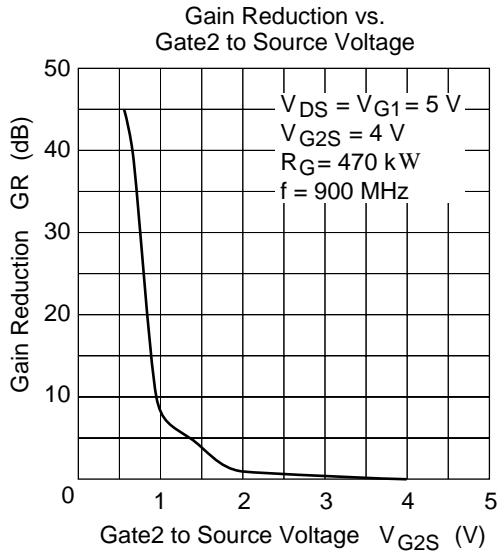

S11 Parameter vs. Frequency

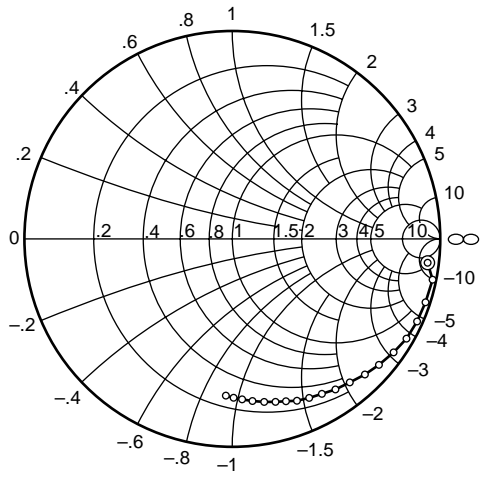

Test Condition : $V_{DS} = 5\text{ V}$, $V_{G1} = 5\text{ V}$
 $V_{G2S} = 4\text{ V}$, $R_G = 470\text{ k}\Omega$
 $Z_0 = 50\ \Omega$
 50 to 1000 MHz (50 MHz step)



S21 Parameter vs. Frequency

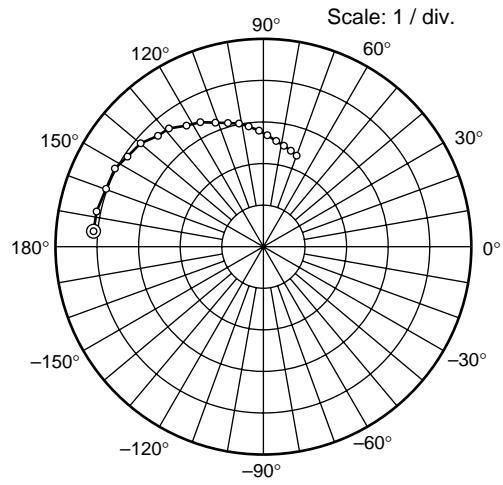

Test Condition : $V_{DS} = 5\text{ V}$, $V_{G1} = 5\text{ V}$
 $V_{G2S} = 4\text{ V}$, $R_G = 470\text{ k}\Omega$
 $Z_0 = 50\ \Omega$
 50 to 1000 MHz (50 MHz step)



S12 Parameter vs. Frequency

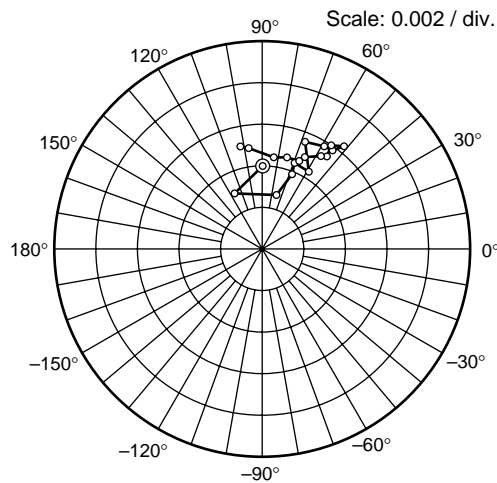

Test Condition : $V_{DS} = 5\text{ V}$, $V_{G1} = 5\text{ V}$
 $V_{G2S} = 4\text{ V}$, $R_G = 470\text{ k}\Omega$
 $Z_0 = 50\ \Omega$
 50 to 1000 MHz (50 MHz step)



S22 Parameter vs. Frequency

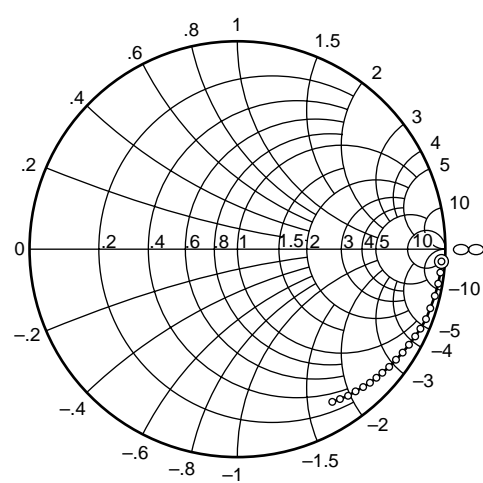

Test Condition : $V_{DS} = 5\text{ V}$, $V_{G1} = 5\text{ V}$
 $V_{G2S} = 4\text{ V}$, $R_G = 470\text{ k}\Omega$
 $Z_0 = 50\ \Omega$
 50 to 1000 MHz (50 MHz step)



BB403M

Sparameter ($V_{DS} = V_{G1} = 5V$, $V_{G2S} = 4V$, $R_G = 470k\Omega$, $Z_O = 50\Omega$)

f (MHz)	S11		S21		S12		S22	
	MAG	ANG	MAG	ANG	MAG	ANG	MAG	ANG
50	0.947	-7.0	4.11	174.4	0.00400	89.0	0.985	-3.1
100	0.978	-11.9	4.13	167.1	0.00305	116.5	0.985	-6.8
150	0.973	-18.7	4.04	159.8	0.00266	75.5	0.982	-10.1
200	0.960	-23.8	4.01	152.7	0.00384	66.8	0.978	-13.5
250	0.956	-29.6	3.90	146.4	0.00453	70.1	0.970	-16.8
300	0.939	-35.5	3.85	139.9	0.00440	59.6	0.965	-20.0
350	0.930	-40.3	3.68	133.6	0.00550	67.2	0.957	-23.1
400	0.905	-45.7	3.63	128.3	0.00571	59.0	0.949	-26.2
450	0.889	-50.3	3.45	122.7	0.00583	54.2	0.940	-29.2
500	0.870	-55.6	3.35	116.6	0.00634	51.6	0.932	-32.1
550	0.855	-59.6	3.22	111.5	0.00596	56.2	0.924	-35.0
600	0.841	-63.9	3.10	106.3	0.00591	55.7	0.917	-37.7
650	0.826	-67.9	3.02	101.4	0.00544	54.9	0.908	-40.5
700	0.812	-71.8	2.89	96.1	0.00533	57.2	0.900	-43.1
750	0.799	-75.6	2.78	91.8	0.00495	64.6	0.893	-45.7
800	0.788	-78.9	2.70	87.5	0.00470	66.5	0.887	-48.1
850	0.778	-82.6	2.60	82.2	0.00460	75.1	0.880	-50.6
900	0.765	-85.8	2.48	78.1	0.00445	83.8	0.874	-52.9
950	0.763	-88.8	2.41	74.2	0.00486	97.0	0.869	-55.3
1000	0.748	-92.2	2.34	69.7	0.00502	102.6	0.864	-57.5

Package Dimensions

Unit: mm

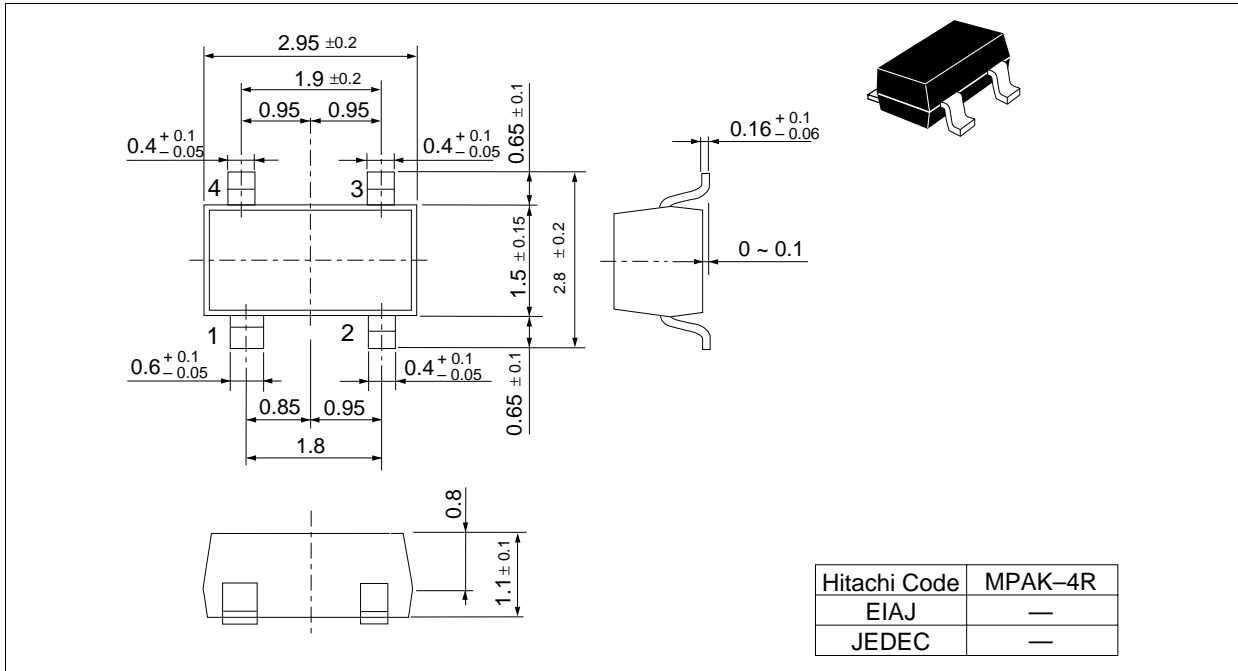

BB403M

Cautions

1. Hitachi neither warrants nor grants licenses of any rights of Hitachi's or any third party's patent, copyright, trademark, or other intellectual property rights for information contained in this document. Hitachi bears no responsibility for problems that may arise with third party's rights, including intellectual property rights, in connection with use of the information contained in this document.
2. Products and product specifications may be subject to change without notice. Confirm that you have received the latest product standards or specifications before final design, purchase or use.
3. Hitachi makes every attempt to ensure that its products are of high quality and reliability. However, contact Hitachi's sales office before using the product in an application that demands especially high quality and reliability or where its failure or malfunction may directly threaten human life or cause risk of bodily injury, such as aerospace, aeronautics, nuclear power, combustion control, transportation, traffic, safety equipment or medical equipment for life support.
4. Design your application so that the product is used within the ranges guaranteed by Hitachi particularly for maximum rating, operating supply voltage range, heat radiation characteristics, installation conditions and other characteristics. Hitachi bears no responsibility for failure or damage when used beyond the guaranteed ranges. Even within the guaranteed ranges, consider normally foreseeable failure rates or failure modes in semiconductor devices and employ systemic measures such as fail-safes, so that the equipment incorporating Hitachi product does not cause bodily injury, fire or other consequential damage due to operation of the Hitachi product.
5. This product is not designed to be radiation resistant.
6. No one is permitted to reproduce or duplicate, in any form, the whole or part of this document without written approval from Hitachi.
7. Contact Hitachi's sales office for any questions regarding this document or Hitachi semiconductor products.

HITACHI

Hitachi, Ltd.

Semiconductor & IC Div.
Nippon Bldg., 2-6-2, Ohte-machi, Chiyoda-ku, Tokyo 100-0004, Japan
Tel: Tokyo (03) 3270-2111 Fax: (03) 3270-5109

URL North America : <http://semiconductor.hitachi.com/>
 Europe : <http://www.hitachi-eu.com/hel/ecg>
 Asia (Singapore) : <http://www.has.hitachi.com.sg/grp3/sicd/index.htm>
 Asia (Taiwan) : http://www.hitachi.com.tw/E/Product/SICD_Frame.htm
 Asia (HongKong) : <http://www.hitachi.com.hk/eng/bo/grp3/index.htm>
 Japan : <http://www.hitachi.co.jp/Sicd/indx.htm>

For further information write to:

Hitachi Semiconductor
(America) Inc.
2000 Sierra Point Parkway
Brisbane, CA 94005-1897
Tel: <1> (800) 285-1601
Fax: <1> (303) 297-0447

Hitachi Europe GmbH
Electronic components Group
Dornacher Straße 3
D-85622 Feldkirchen, Munich
Germany
Tel: <49> (89) 9 9180-0
Fax: <49> (89) 9 29 30 00

Hitachi Europe Ltd.
Electronic Components Group.
Whitebrook Park
Lower Cookham Road
Maidenhead
Berkshire SL6 8YA, United Kingdom
Tel: <44> (1628) 585000
Fax: <44> (1628) 778322

Hitachi Asia Pte. Ltd.
16 Collyer Quay #20-00
Hitachi Tower
Singapore 049318
Tel: 535-2100
Fax: 535-1533

Hitachi Asia Ltd.
Taipei Branch Office
3F, Hung Kuo Building, No.167,
Tun-Hwa North Road, Taipei (105)
Tel: <886> (2) 2718-3666
Fax: <886> (2) 2718-8180

Hitachi Asia (Hong Kong) Ltd.
Group III (Electronic Components)
7/F., North Tower, World Finance Centre,
Harbour City, Canton Road, Tsim Sha Tsui,
Kowloon, Hong Kong
Tel: <852> (2) 735 9218
Fax: <852> (2) 730 0281
Telex: 40815 HITEC HX

Copyright © Hitachi, Ltd., 1998. All rights reserved. Printed in Japan.