



SANYO Semiconductors DATA SHEET

STK672-110-E

Thick-Film Hybrid IC
Unipolar Fixed-Current Chopper (Self-Excited PWM)
Scheme and Built-in Phase Signal Distribution IC
Two-Phase Stepping Motor Driver
(Square Wave Drive) Output Current 1.8A

Overview

The STK672-110-E is a unipolar fixed-current chopper type 2-phase stepping motor driver hybrid IC. It features power MOSFETs in the output stage and a built-in phase signal distribution IC. The incorporation of a phase distribution IC allows the STK672-110-E to control the speed of the motor based on the frequency of an external input clock signal. It supports two types of excitation for motor control: 2-phase excitation and 1-2 phase excitation. It also provides a function for switching the motor direction.

Applications

- Two-phase stepping motor drive in send/receive facsimile units
- Paper feed in copiers, industrial robots, and other applications that require 2-phase stepping motor drive

Features

- The motor speed can be controlled by the frequency of an external clock signal (the CLOCK pin signal).
- The excitation type is switched according to the state (low or high) of the MODE pin. The mode is set to 2-phase or 1-2 phase excitation on the rising edge of the clock signal.
- A motor direction switching pin (the CWB pin) is provided.
- All inputs are schmitt inputs and 40k Ω (typical: -50 to +100%) pull-up resistors are built in.
- The motor current can be set by changing the Vref pin voltage. Since a 0.22 Ω current detection resistor is built in, a current of 1A is set for each 0.22V of applied voltage.
- The input frequency range for the clock signal used for motor speed control is 0 to 25kHz.
- Supply voltage ranges: V_{CC} = 10 to 42V, V_{DD} = 5.0V \pm 5%
- This IC supports motor operating currents of up to 1.8A at T_c = 105 $^{\circ}$ C, and of up to 2.65A at T_c = 25 $^{\circ}$ C.

■ Any and all SANYO Semiconductor Co.,Ltd. products described or contained herein are, with regard to "standard application", intended for the use as general electronics equipment (home appliances, AV equipment, communication device, office equipment, industrial equipment etc.). The products mentioned herein shall not be intended for use for any "special application" (medical equipment whose purpose is to sustain life, aerospace instrument, nuclear control device, burning appliances, transportation machine, traffic signal system, safety equipment etc.) that shall require extremely high level of reliability and can directly threaten human lives in case of failure or malfunction of the product or may cause harm to human bodies, nor shall they grant any guarantee thereof. If you should intend to use our products for applications outside the standard applications of our customer who is considering such use and/or outside the scope of our intended standard applications, please consult with us prior to the intended use. If there is no consultation or inquiry before the intended use, our customer shall be solely responsible for the use.

■ Specifications of any and all SANYO Semiconductor Co.,Ltd. products described or contained herein stipulate the performance, characteristics, and functions of the described products in the independent state, and are not guarantees of the performance, characteristics, and functions of the described products as mounted in the customer's products or equipment. To verify symptoms and states that cannot be evaluated in an independent device, the customer should always evaluate and test devices mounted in the customer's products or equipment.

SANYO Semiconductor Co., Ltd.

TOKYO OFFICE Tokyo Bldg., 1-10, 1 Chome, Ueno, Taito-ku, TOKYO, 110-8534 JAPAN

61108HKIM/12799RM (OT) No.6041-1/9

Specifications

Maximum Ratings at $T_c = 25^\circ\text{C}$

Parameter	Symbol	Conditions	Ratings	Unit
Maximum supply voltage 1	V_{CC} max	No signal	52	V
Maximum supply voltage 2	V_{DD} max	No signal	-0.3 to +7.0	V
Input voltage	V_{IN} max	Logic input pins	-0.3 to +7.0	V
Output current	I_{OH} max	$V_{DD} = 5\text{V}$, $\text{CLOCK} \geq 200\text{Hz}$	2.65	A
Repeated avalanche capacity	Ear max		28	mJ
Allowable power dissipation	P_d max	With an arbitrarily large heat sink. Per MOSFET	6.5	W
Operating substrate temperature	T_c max		105	$^\circ\text{C}$
Junction temperature	T_j max		150	$^\circ\text{C}$
Storage temperature	T_{stg}		-40 to +125	$^\circ\text{C}$

Allowable Operating Ranges at $T_a = 25^\circ\text{C}$

Parameter	Symbol	Conditions	Ratings	Unit
Maximum supply voltage 1	V_{CC}	With signals applied	10 to 42	V
Maximum supply voltage 2	V_{DD}	With signals applied	$5.0 \pm 5\%$	V
Input voltage	V_{IH}		0 to V_{DD}	V
Output current 1	I_{OH1}	$T_c = 105^\circ\text{C}$, $\text{CLOCK} \geq 200\text{Hz}$	1.8	A
Output current 2	I_{OH2}	$T_c = 80^\circ\text{C}$, $\text{CLOCK} \geq 200\text{Hz}$ See the motor current (I_{OH}) derating curve	2.1	A
Clock frequency	f_{CL}	Minimum pulse width: 20 μs	0 to 25	kHz
Phase driver withstand voltage	V_{DSS}	$I_D = 1\text{mA}$ ($T_c = 25^\circ\text{C}$)	100 min	V

Electrical Characteristics at $T_c = 25^\circ\text{C}$, $V_{CC} = 24\text{V}$, $V_{DD} = 5\text{V}$

Parameters	Symbols	Conditions	Rating			unit
			min	typ	max	
V_{DD} supply current	I_{CCO}	$\text{CLOCK} = \text{GND}$		2.6	6	mA
Output average current	I_{oave}	With $R/L = 3\Omega/3.8\text{mH}$ in each phase $V_{ref} = 0.176\text{V}$	0.41	0.45	0.50	A
FET diode forward voltage	V_{df}	$I_f = 1\text{A}$ ($R_L = 23\Omega$)		1.2	1.8	V
Output saturation voltage	V_{sat}	$R_L = 23\Omega$		0.73	1.02	V
High-level input voltage	V_{IH}	Pins 6 to 9 (4 pins)	4.0			V
Low-level input voltage	V_{IL}	Pins 6 to 9 (4 pins)			1.0	V
Input current	I_{IL}	With pins 6 to 9 at the ground level. Pull-up resistance: 40k Ω (typical)	62	125	250	μA
V_{ref} input voltage	V_{rH}	Pin 12	0		3.5	V
V_{ref} input bias current	I_{IB}	With pin 12 at 1V		50	500	nA

Note: A fixed-voltage power supply must be used.

Package Dimensions

unit:mm (typ)

4168

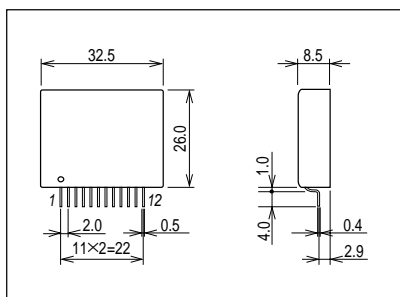

Internal Equivalent Circuit Block Diagram

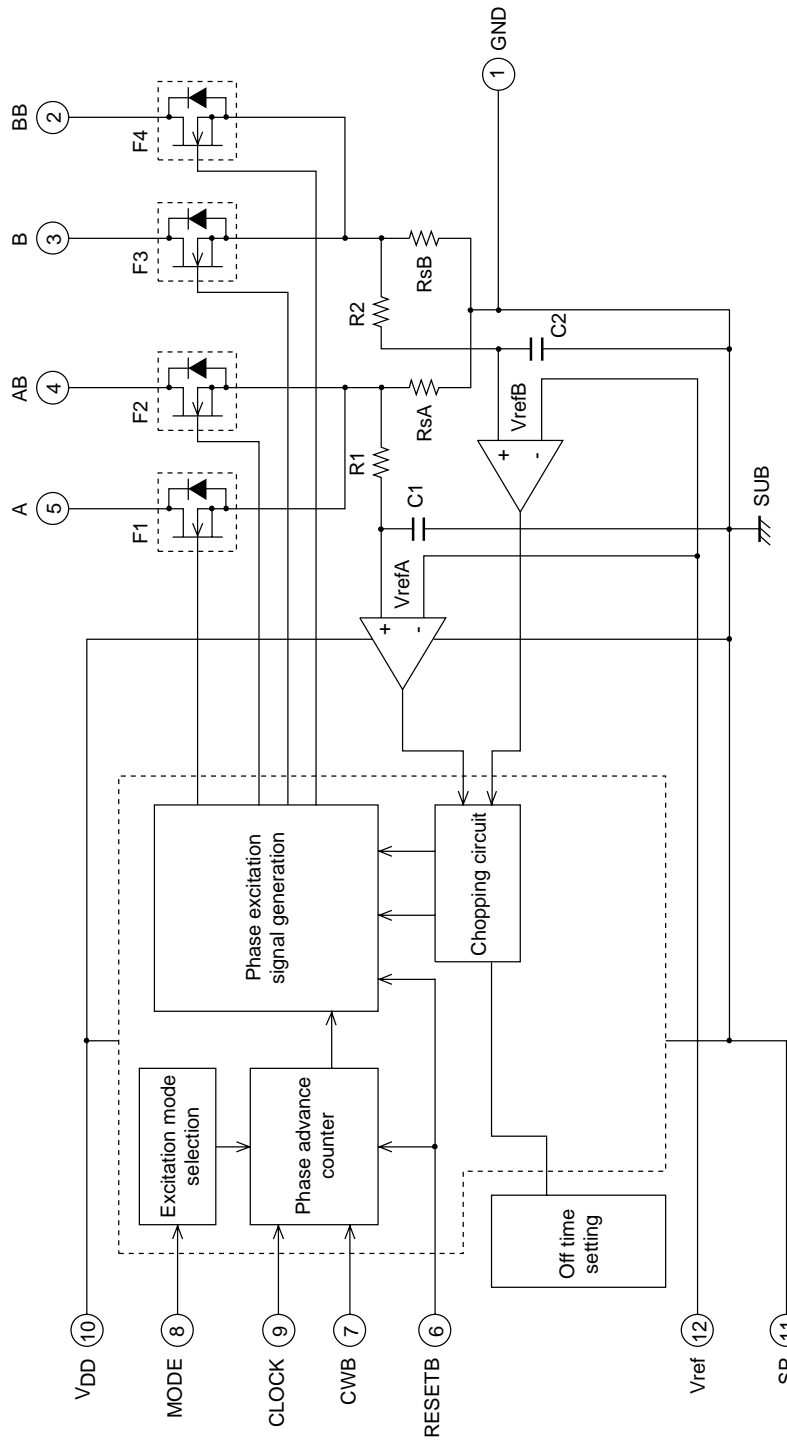

ITF02596

Sample Application Circuit

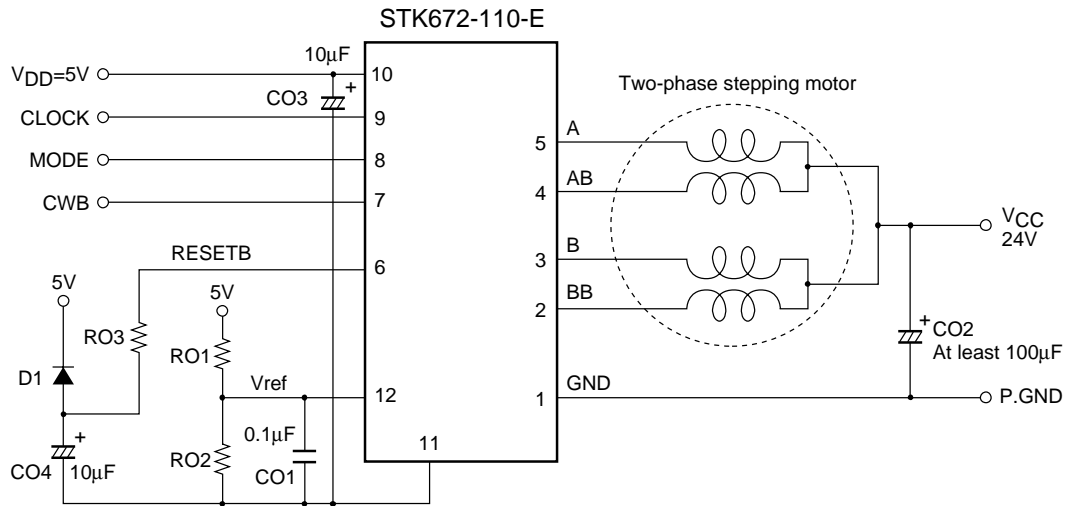

ITF02597

- To minimize noise in the 5V system, locate the ground side of capacitor CO2 in the above circuit as close as possible to pin 1 of the IC.
- Insert resistor RO3 (47 to 100Ω) so that the discharge energy from capacitor CO4 is not directly applied to the CMOS IC in this hybrid device. If the diode D1 has Vf characteristics with Vf less than or equal to 0.6V (when If = 0.1A), this will be smaller than the CMOS IC input pin diode Vf. If this is the case RO3 may be replaced with a short without problem.
- Standard or HC type input levels are used for the pin 7, 8, and 9 inputs.
- If open-collector type circuits are used for the pin 7, 8, and 9 inputs, these circuit will be in the high-impedance state for high level inputs. As a result, chopping circuit noise may cause the input circuits to operate incorrectly. To prevent incorrect operation due to such noise, capacitors with values between 470 and 1000pF must be connected between pins 7 and 11, 8 and 11, and 9 and 11. (A capacitor with a value between 470 and 1000pF must be connected between pins 6 and 11 as well if an open-collector output IC is used for the RESETB pin (pin 6) input.)
- Taking the input bias current (IIB) characteristics into account, the resistor RO1 must not exceed 100kΩ.
- The following circuit (for a lowered current of over 0.2A) is recommended if the application needs to temporarily lower the motor current. Here, a value of close to 100kΩ must be used for resistor RO1 to make the transistor output saturation voltage as low as possible.

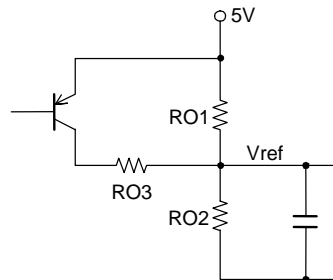
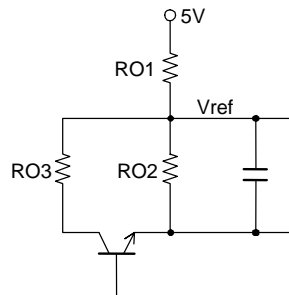

Input Pin Functions (CMOS input levels)

Pin	Pin No.	Function	Input conditions when operating
CLOCK	9	Reference clock for motor phase current switching	Operates on the rising edge of the signal
MODE	8	Excitation mode selection	Low: 2-phase excitation High: 1-2 phase excitation
CWB	7	Motor direction switching	Low: CW (forward) High: CCW (reverse)
RESETB	6	System reset and A, AB, B, and BB outputs cutoff. Applications must apply a reset signal for at least 20μs when power is first applied.	A reset is applied by a low level

- A simple reset function is formed from D1, CO4, and RO3 in this application circuit. With the CLOCK input held low, when the 5V supply voltage is brought up a reset is applied if the motor output phases A and BB are driven. If the 5V supply voltage rise time is slow (over 50ms), the motor output phases A and BB may not be driven. Increase the value of the capacitor CO4 and check circuit operation again.
- See the timing chart for the concrete details on circuit operation.

Usage Notes

- 5V system input pins

[RESETB and CLOCK (Input signal timing when power is first applied)]

As shown in the timing chart, a RESETB signal input is required by the driver to operate with the timing in which the F1 gate is turned on first. The RESETB signal timing must be set up to have a width of at least 20μs, as shown below. The capacitor CO4 and the resistor RO3 in the application circuit form simple reset circuit that uses the RC time constant rising time. However, when designing the RESETB input based on CMOS levels, the application must have the timing shown in figure 1.

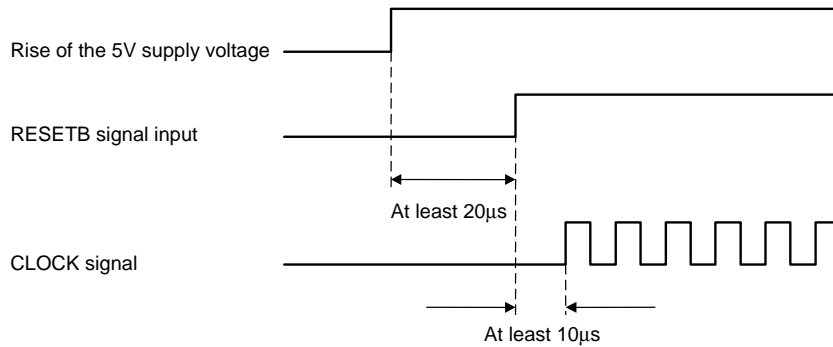

Figure 1 RESETB and CLOCK Signals Input Timing

See the timing chart for details on the CLOCK, MODE, CWB, and other input pins.

[Vref <Motor current peak value setting>]

In the sample application circuit, the peak value of the motor current (I_{OH}) is set by RO1, RO2, and V_{DD} (5V) as described by the formula below.

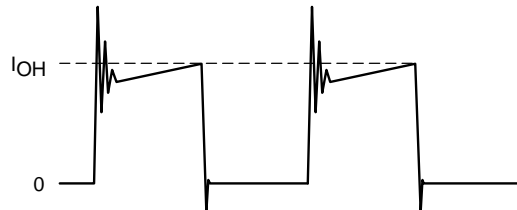

Figure 2 Motor Current I_{OH} Flowing into the Driver IC

$I_{OH} = V_{ref} \div R_s$ Here, R_s is hybrid IC internal current detection resistor

$V_{ref} = (R02 \div (R01 + R02)) \times 5V$

STK672-110-E: $R_s = 0.22\Omega$

- Allowable motor current operating range

The motor current (I_{OH}) must be held within the range corresponding to the area under the curve shown in figure 4. For example, if the operating substrate temperature T_c is 105°C , then I_{OH} must be held under $I_{OH} = 1.8\text{A}$, and in hold mode I_{OH} must be held under $I_{OH} = 1.5\text{A}$.

- Thermal design

[Operating range in which a heat sink is not used]

The STK672-110-E package has a structure that uses no screws, and is recommended for use without a heat sink.

This section discusses the safe operating range when no heat sink is used.

In the maximum ratings specifications, T_c max is specified to be 105°C , and when mounted in an actual end product system, the T_c max value must never be exceeded during operation. T_c can be expressed by formula (A) below, and thus the range for ΔT_c must be stipulated so that T_c is always under 105°C .

$$T_c = T_a + \Delta T_c \quad (\text{A})$$

T_a : Hybrid IC ambient temperature, ΔT_c : Temperature increase across the aluminum substrate

As shown in figure 6, the value of ΔT_c increases as the hybrid IC internal average power dissipation P_D increases. As shown in figure 5, P_D increases with the motor current. Here we describe the actual P_D calculation using the example shown in the motor current timing chart in figure 3.

Since there are periods when current flows and periods when the current is off during actual motor operation, P_D cannot be determined from the data presented in figure 5. Therefore, we calculate P_D assuming that actual motor operation consists of repetitions of the operation shown in figure 3.

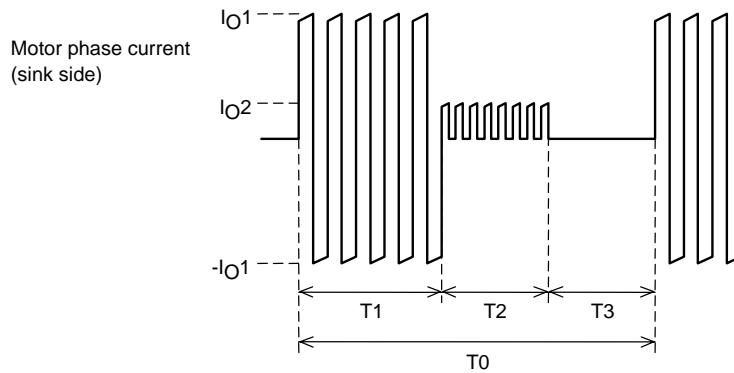

Figure 3 Motor Current Timing

T1: Motor rotation operation time

T2: Motor hold operation time

T3: Motor current off time

T2 may be reduced, depending on the application.

T0: Single repeated motor operating cycle

I_{O1} and I_{O2} : Motor current peak values

Due to the structure of motor windings, the phase current is a positive and negative current with a pulse form.

Note that figure 3 presents the concepts here, and that the on/off duty of the actual signals will differ.

The hybrid IC internal average power dissipation P_D can be calculated from the following formula.

$$P_D = (T1 \times P1 + T2 \times P2 + T3 \times 0) \div T0 \quad (\text{I})$$

(Here, $P1$ is the P_D for I_{O1} and $P2$ is the P_D for I_{O2})

If the value calculated in formula (I) above is under 1.4W , then from figure 6 we see that operation is allowed up to an ambient temperature T_a of 60°C .

While the operating range when a heat sink is not used can be determined from formula (I) above, figure 5 is merely a single example of one operating mode for a single motor.

For example, while figure 5 shows a 2-phase excitation motor, if 1-2 phase excitation is used with a 500Hz clock frequency, the drive will be turned off for 25% of the time and the dissipation P_D will be reduced to 75% of that in figure 5.

It is extremely difficult for SANYO to calculate the internal average power dissipation P_D for all possible end product conditions. After performing the above rough calculations, always install the hybrid IC in an actual end product and verify that the substrate temperature T_c does not rise above 105°C .

Timing Chart

2-phase excitation

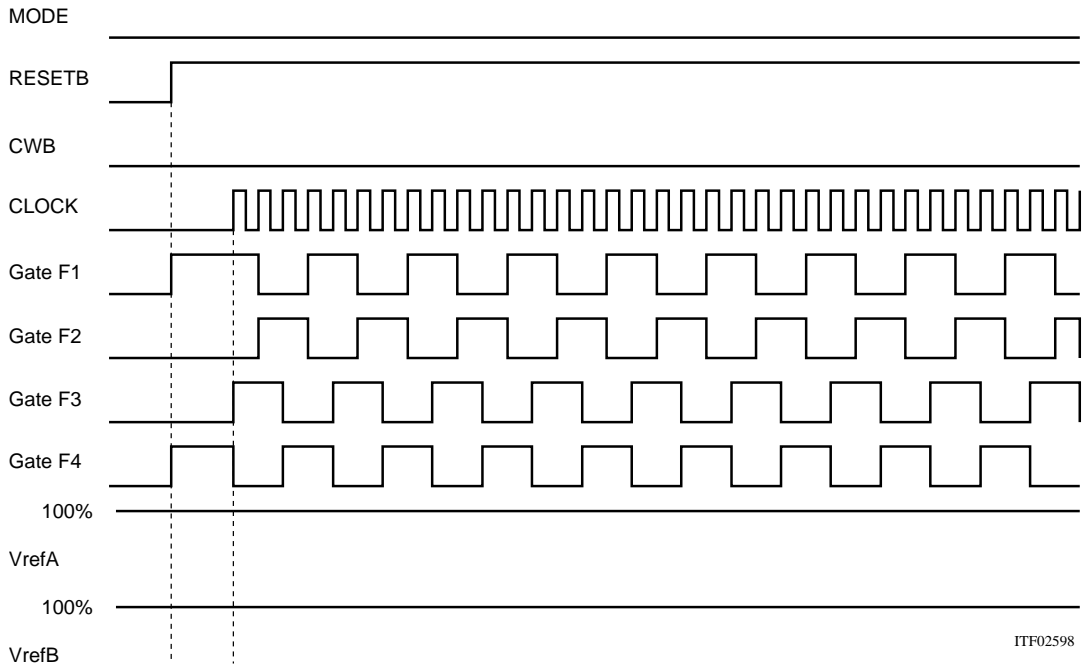

1-2 phase excitation

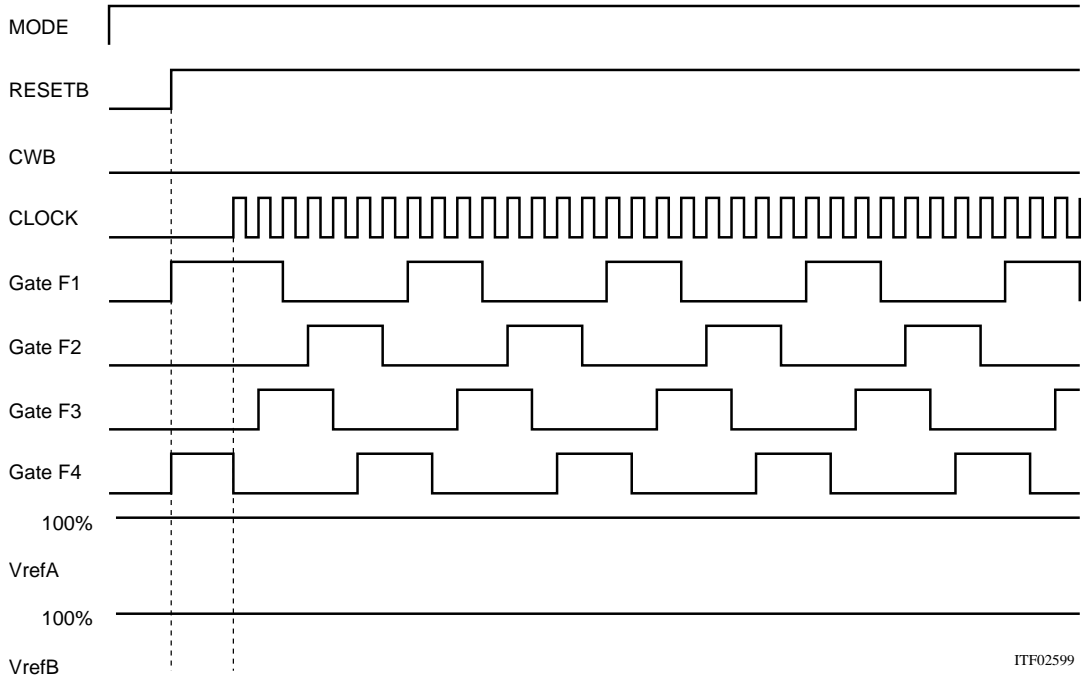

1-2 phase excitation (CWB)

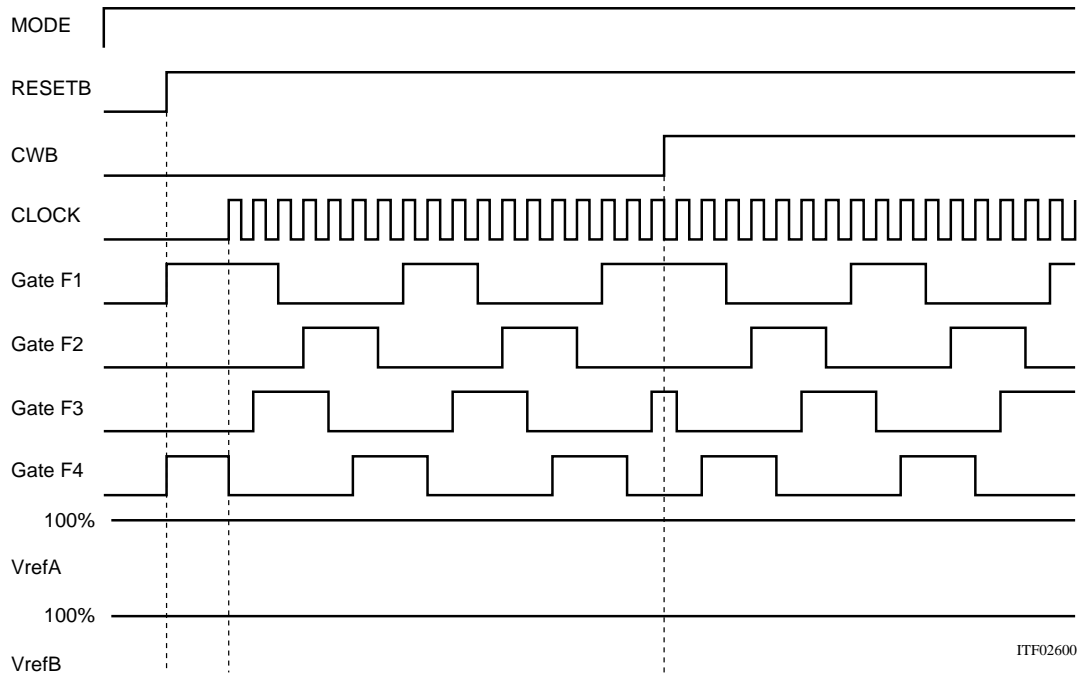

Switching from 2-phase to 1-2 phase excitation

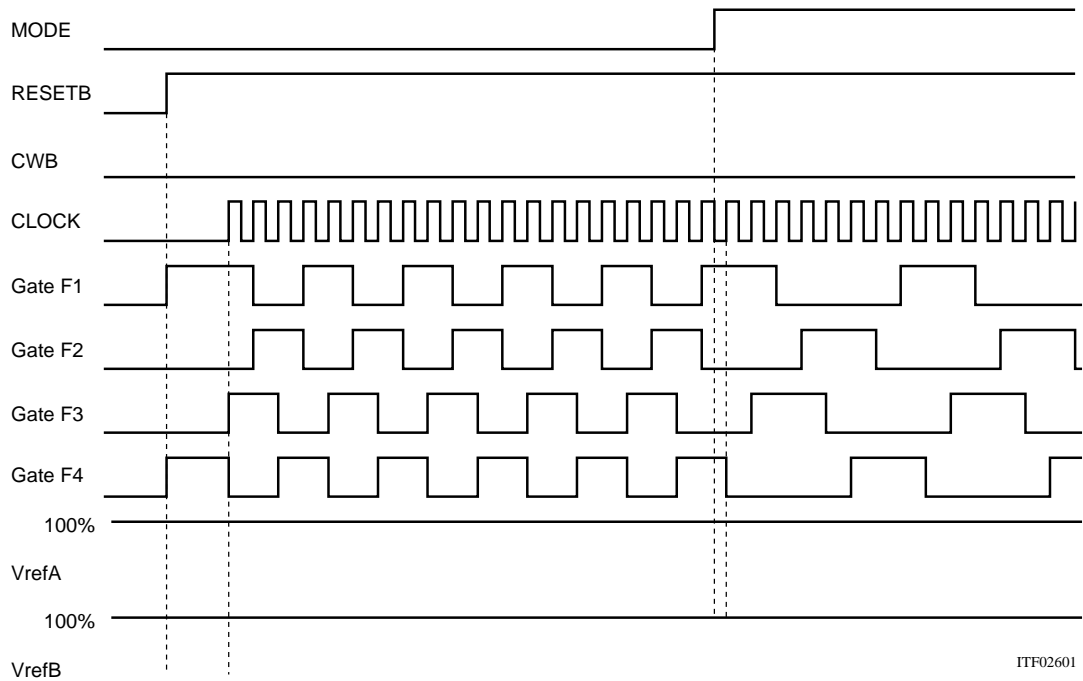

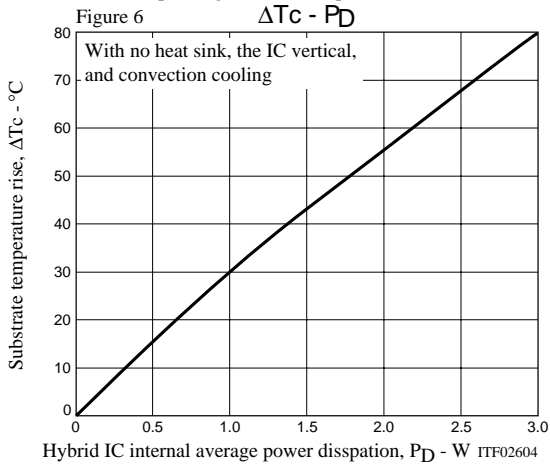
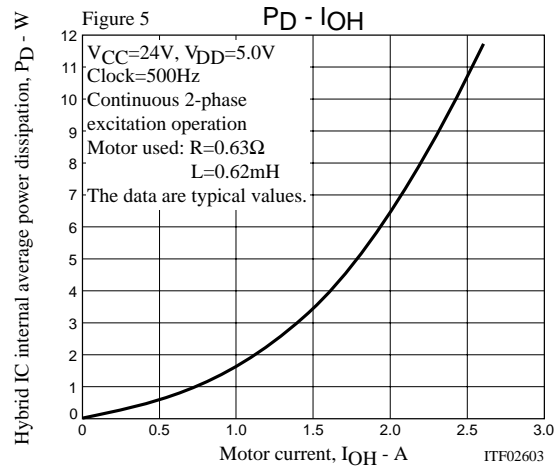
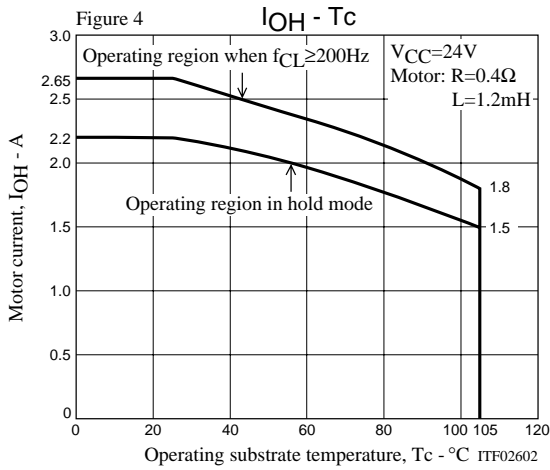

- SANYO Semiconductor Co.,Ltd. assumes no responsibility for equipment failures that result from using products at values that exceed, even momentarily, rated values (such as maximum ratings, operating condition ranges, or other parameters) listed in products specifications of any and all SANYO Semiconductor Co.,Ltd. products described or contained herein.
- SANYO Semiconductor Co.,Ltd. strives to supply high-quality high-reliability products, however, any and all semiconductor products fail or malfunction with some probability. It is possible that these probabilistic failures or malfunction could give rise to accidents or events that could endanger human lives, trouble that could give rise to smoke or fire, or accidents that could cause damage to other property. When designing equipment, adopt safety measures so that these kinds of accidents or events cannot occur. Such measures include but are not limited to protective circuits and error prevention circuits for safe design, redundant design, and structural design.
- In the event that any or all SANYO Semiconductor Co.,Ltd. products described or contained herein are controlled under any of applicable local export control laws and regulations, such products may require the export license from the authorities concerned in accordance with the above law.
- No part of this publication may be reproduced or transmitted in any form or by any means, electronic or mechanical, including photocopying and recording, or any information storage or retrieval system, or otherwise, without the prior written consent of SANYO Semiconductor Co.,Ltd.
- Any and all information described or contained herein are subject to change without notice due to product/technology improvement, etc. When designing equipment, refer to the "Delivery Specification" for the SANYO Semiconductor Co.,Ltd. product that you intend to use.
- Information (including circuit diagrams and circuit parameters) herein is for example only; it is not guaranteed for volume production.
- Upon using the technical information or products described herein, neither warranty nor license shall be granted with regard to intellectual property rights or any other rights of SANYO Semiconductor Co.,Ltd. or any third party. SANYO Semiconductor Co.,Ltd. shall not be liable for any claim or suits with regard to a third party's intellectual property rights which has resulted from the use of the technical information and products mentioned above.

This catalog provides information as of June, 2008. Specifications and information herein are subject to change without notice.