

## Dual P-Channel 30-V (D-S) MOSFET

<b>PRODUCT SUMMARY</b>			
$V_{DS}$ (V)	$r_{DS(on)}$ ( $\Omega$ )	$I_D$ (A)	$Q_g$ (Typ)
-30	0.020 @ $V_{GS} = -10$ V	-10.9	49
	0.031 @ $V_{GS} = -4.5$ V	-8.8	

### FEATURES

- TrenchFET® Power MOSFET
- New Low Thermal Resistance PowerPAK® Package with Low 1.07-mm Profile

### APPLICATIONS

- Battery and Load Switching
  - Notebook PCs
  - Game Systems
  - Set-Top Boxer

**PowerPAK SO-8**

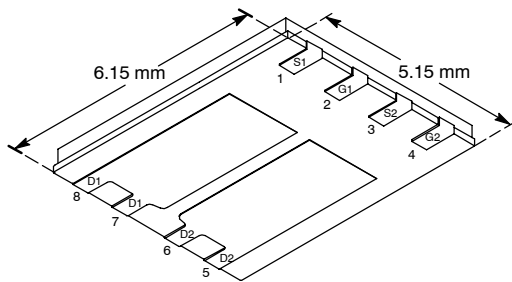

Bottom View

Ordering Information: Si7945DP-T1  
Si7945DP-T1—E3 (Lead (Pb)-Free)

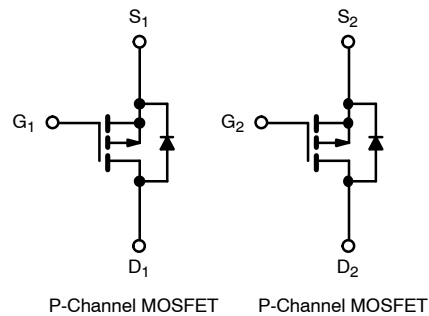

P-Channel MOSFET      P-Channel MOSFET

<b>ABSOLUTE MAXIMUM RATINGS (<math>T_A = 25^\circ\text{C}</math> UNLESS OTHERWISE NOTED)</b>					
Parameter		Symbol	10 secs	Steady State	Unit
Drain-Source Voltage		$V_{DS}$	-30		V
Gate-Source Voltage		$V_{GS}$	$\pm 20$		
Continuous Drain Current ( $T_J = 150^\circ\text{C}$ ) <sup>a</sup>	$T_A = 25^\circ\text{C}$	$I_D$	-10.9	-7.0	A
	$T_A = 70^\circ\text{C}$		-8.7	-5.6	
Pulsed Drain Current		$I_{DM}$	-30		
continuous Source Current (Diode Conduction) <sup>a</sup>		$I_S$	-2.9	-1.2	
Maximum Power Dissipation <sup>a</sup>	$T_A = 25^\circ\text{C}$	$P_D$	3.5	1.4	W
	$T_A = 70^\circ\text{C}$		2.2	0.9	
Operating Junction and Storage Temperature Range		$T_J, T_{stg}$	-55 to 150		$^\circ\text{C}$

<b>THERMAL RESISTANCE RATINGS</b>					
Parameter		Symbol	Typical	Maximum	Unit
Maximum Junction-to-Ambient <sup>a</sup>	$t \leq 10$ sec	$R_{thJA}$	26	35	$^\circ\text{C/W}$
	Steady State		60	85	
Maximum Junction-to-Case (Drain)	Steady State	$R_{thJC}$	2.5	3.1	

**Notes**

a. Surface Mounted on 1" x 1" FR4 Board.

**SPECIFICATIONS (T<sub>J</sub> = 25 °C UNLESS OTHERWISE NOTED)**

Parameter	Symbol	Test Condition	Min	Typ	Max	Unit
<b>Static</b>						
Gate Threshold Voltage	V <sub>GS(th)</sub>	V <sub>DS</sub> = V <sub>GS</sub> , I <sub>D</sub> = -250 μA	-1.0		-3.0	V
Gate-Body Leakage	I <sub>GSS</sub>	V <sub>DS</sub> = 0 V, V <sub>GS</sub> = ±20 V			±100	nA
Zero Gate Voltage Drain Current	I <sub>DSS</sub>	V <sub>DS</sub> = -30 V, V <sub>GS</sub> = 0 V			-1	μA
		V <sub>DS</sub> = -30 V, V <sub>GS</sub> = 0 V, T <sub>J</sub> = 55 °C			-5	
On-State Drain Current <sup>a</sup>	I <sub>D(on)</sub>	V <sub>DS</sub> ≤ -5 V, V <sub>GS</sub> = -10 V	-30			A
Drain-Source On-State Resistance <sup>a</sup>	r <sub>DS(on)</sub>	V <sub>GS</sub> = -10 V, I <sub>D</sub> = -10.9 A		0.016	0.020	Ω
		V <sub>GS</sub> = -4.5 V, I <sub>D</sub> = -8.8 A		0.025	0.031	
Forward Transconductance <sup>a</sup>	g <sub>fs</sub>	V <sub>DS</sub> = -15 V, I <sub>D</sub> = -10.9 A		26		S
Diode Forward Voltage <sup>a</sup>	V <sub>SD</sub>	I <sub>S</sub> = -2.9 A, V <sub>GS</sub> = 0 V		-0.8	-1.2	V
<b>Dynamic<sup>b</sup></b>						
Total Gate Charge	Q <sub>g</sub>	V <sub>DS</sub> = -15 V, V <sub>GS</sub> = -10 V, I <sub>D</sub> = -10.9 A		49	74	nC
Gate-Source Charge	Q <sub>gs</sub>			7.3		
Gate-Drain Charge	Q <sub>gd</sub>			13		
Turn-On Delay Time	t <sub>d(on)</sub>	V <sub>DD</sub> = -15 V, R <sub>L</sub> = 15 Ω I <sub>D</sub> ≅ -1 A, V <sub>GEN</sub> = -10 V, R <sub>g</sub> = 6 Ω		15	25	ns
Rise Time	t <sub>r</sub>			15	25	
Turn-Off Delay Time	t <sub>d(off)</sub>			130	200	
Fall Time	t <sub>f</sub>			80	120	
Source-Drain Reverse Recovery Time	t <sub>rr</sub>		I <sub>F</sub> = -2.9 A, di/dt = 100 A/μs		85	

## Notes

- a. Pulse test; pulse width ≤ 300 μs, duty cycle ≤ 2%.  
b. Guaranteed by design, not subject to production testing.

Stresses beyond those listed under "Absolute Maximum Ratings" may cause permanent damage to the device. These are stress ratings only, and functional operation of the device at these or any other conditions beyond those indicated in the operational sections of the specifications is not implied. Exposure to absolute maximum rating conditions for extended periods may affect device reliability.

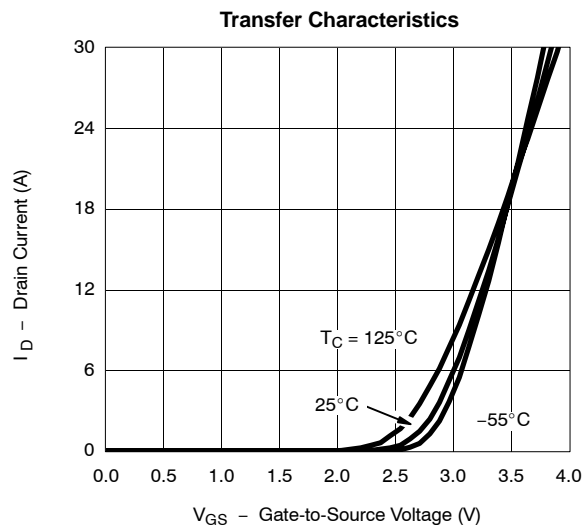
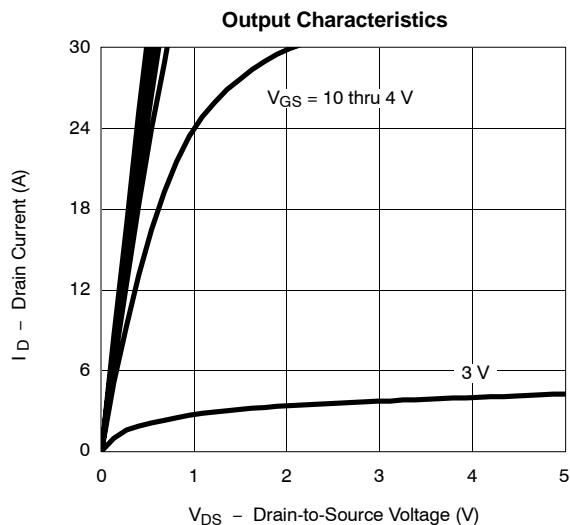
**TYPICAL CHARACTERISTICS (25 °C UNLESS NOTED)**

**TYPICAL CHARACTERISTICS (25 °C UNLESS NOTED)**

**On-Resistance vs. Drain Current**

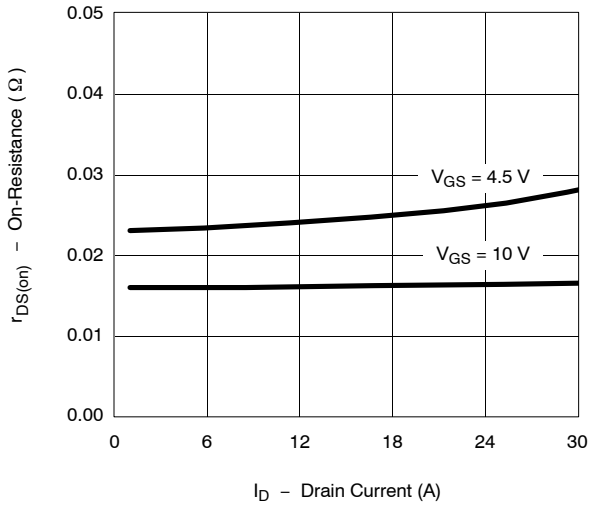

**Capacitance**

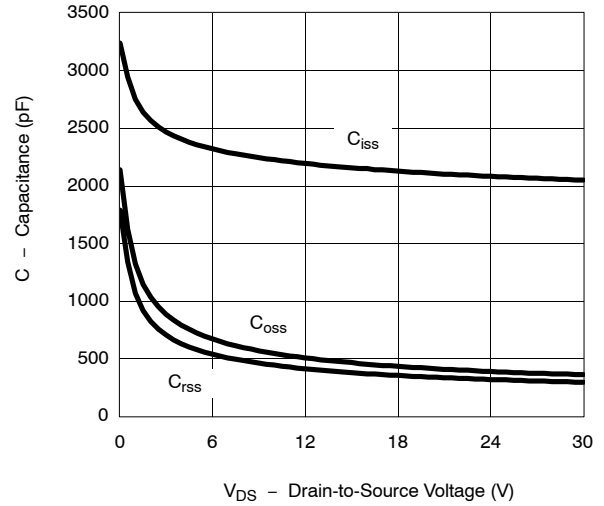

**Gate Charge**

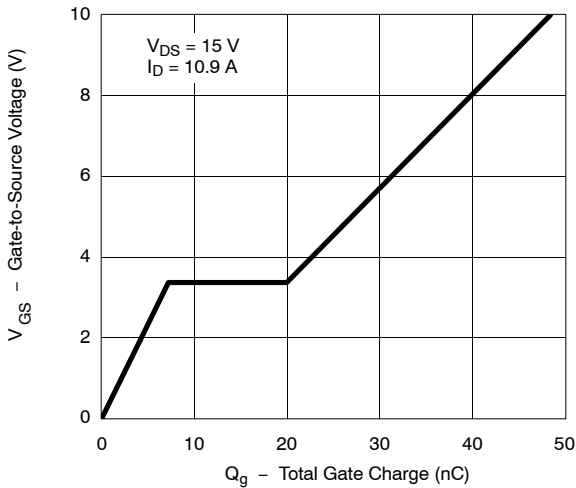

**On-Resistance vs. Junction Temperature**

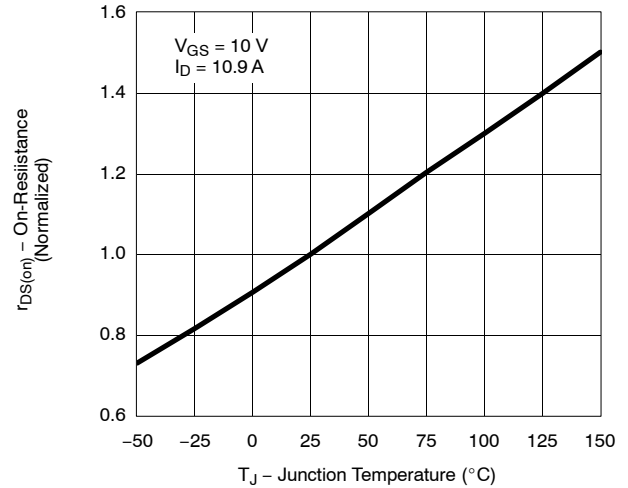

**Source-Drain Diode Forward Voltage**

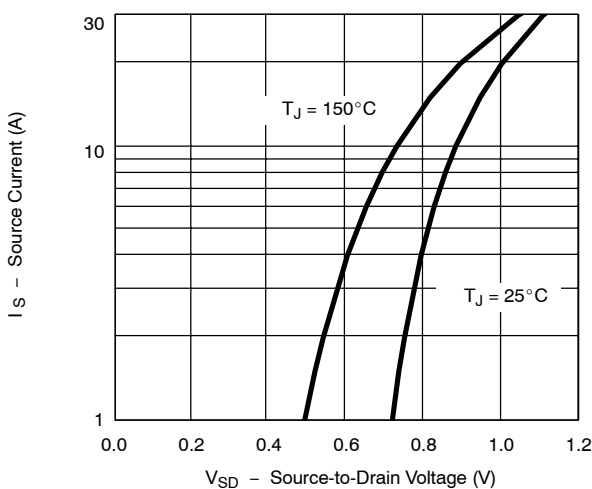

**On-Resistance vs. Gate-to-Source Voltage**

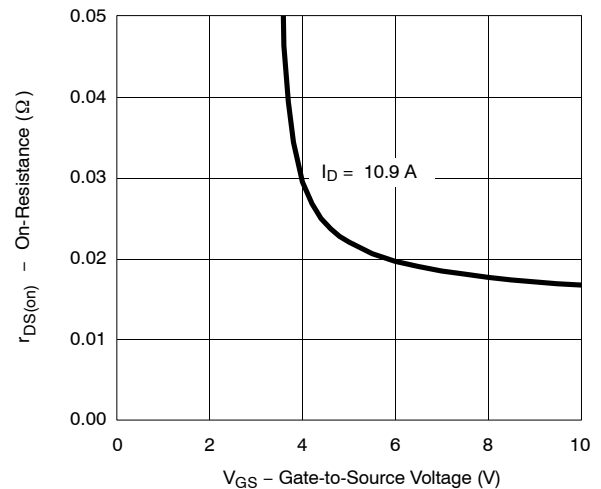

**TYPICAL CHARACTERISTICS (25 °C UNLESS NOTED)**

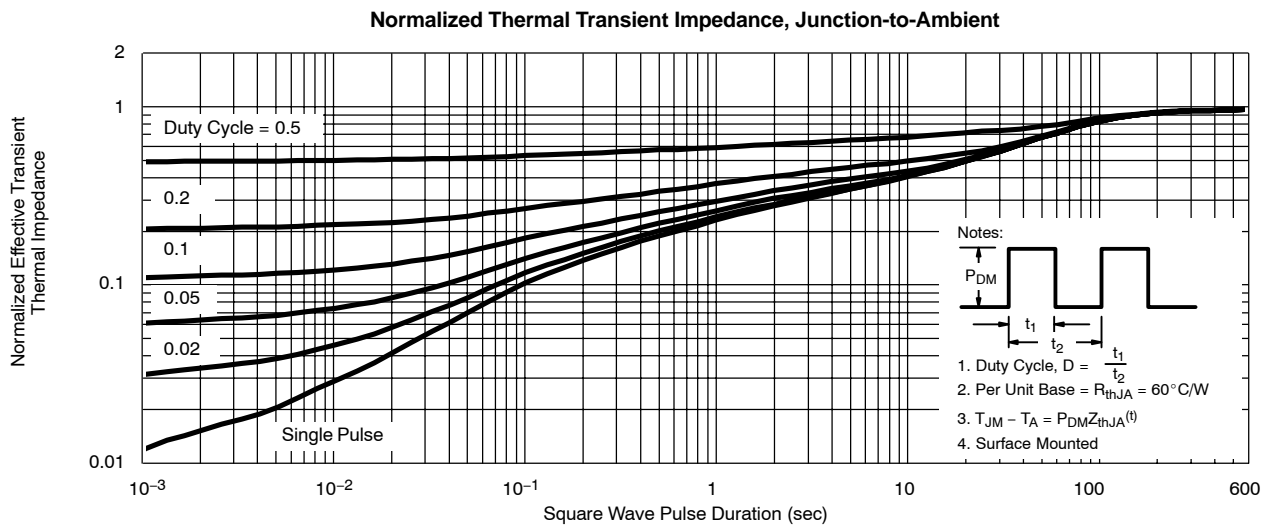
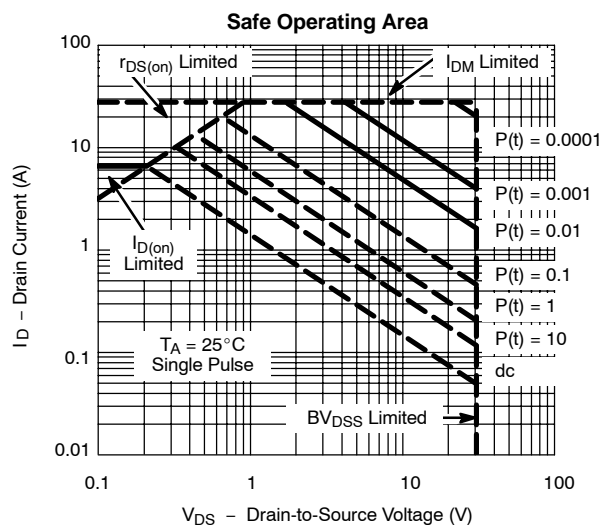
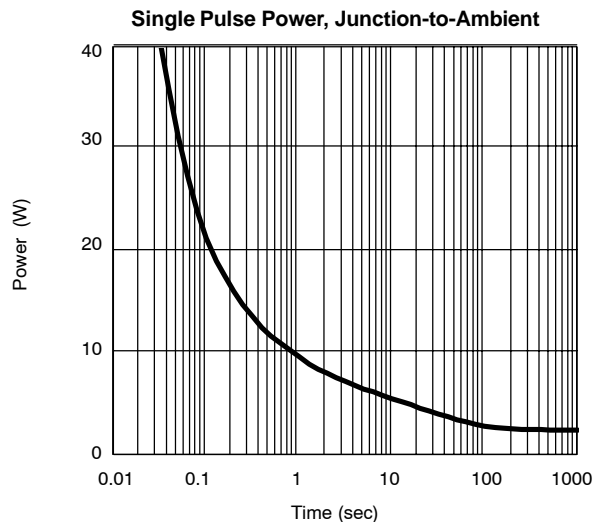
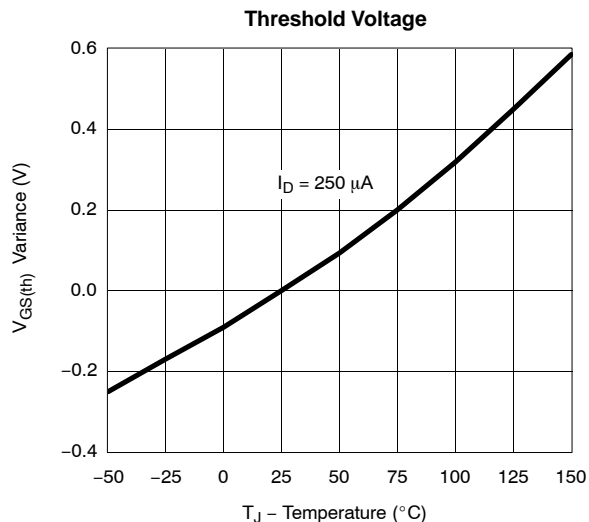



**TYPICAL CHARACTERISTICS (25 °C UNLESS NOTED)**

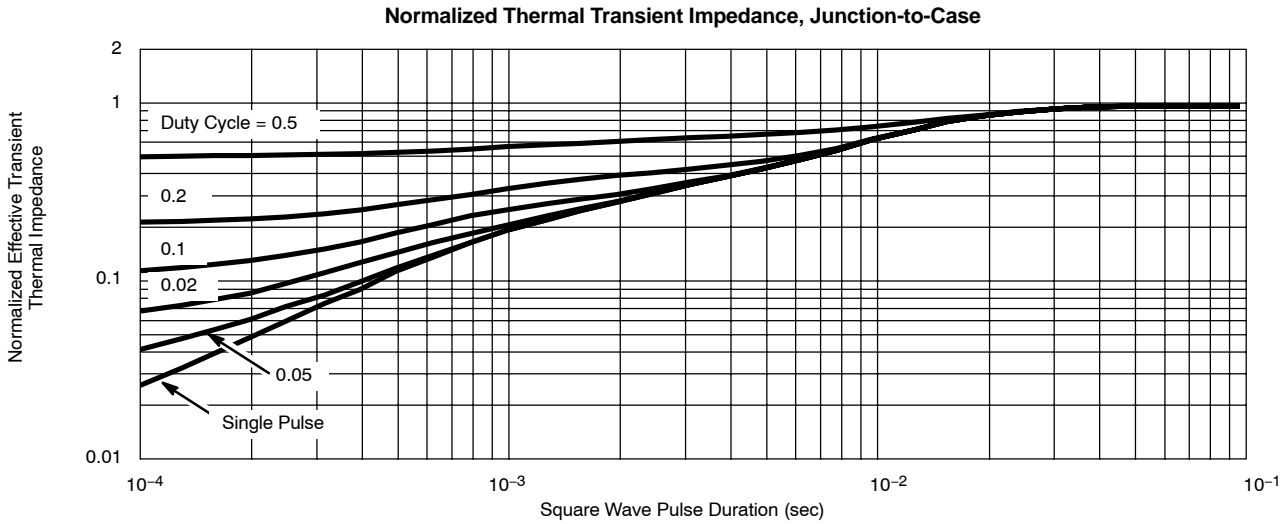

Vishay Siliconix maintains worldwide manufacturing capability. Products may be manufactured at one of several qualified locations. Reliability data for Silicon Technology and Package Reliability represent a composite of all qualified locations. For related documents such as package/tape drawings, part marking, and reliability data, see <http://www.vishay.com/ppg?72090>.



## Notice

Specifications of the products displayed herein are subject to change without notice. Vishay Intertechnology, Inc., or anyone on its behalf, assumes no responsibility or liability for any errors or inaccuracies.

Information contained herein is intended to provide a product description only. No license, express or implied, by estoppel or otherwise, to any intellectual property rights is granted by this document. Except as provided in Vishay's terms and conditions of sale for such products, Vishay assumes no liability whatsoever, and disclaims any express or implied warranty, relating to sale and/or use of Vishay products including liability or warranties relating to fitness for a particular purpose, merchantability, or infringement of any patent, copyright, or other intellectual property right.

The products shown herein are not designed for use in medical, life-saving, or life-sustaining applications. Customers using or selling these products for use in such applications do so at their own risk and agree to fully indemnify Vishay for any damages resulting from such improper use or sale.