

High Current, High Speed LDO Regulators, Voltage Detector Function

GENERAL DESCRIPTION

The XC6402 series are precise, low noise, high current, positive voltage low dropout regulators with built-in voltage detector. They are fabricated using Torex's CMOS process. The series features a voltage reference, an error amplifier, a current limiter, a voltage detector and a phase compensation circuit plus a driver transistor.

The output voltage of the LDO and detect voltage of the detector is selectable in 50mV increments within the range of 0.8V to 5.0V. With a low ON resistance driver transistor built-in, batteries can be used until input-output voltage differential is minimal and can accordingly be used for a longer time.

The series is also compatible with low ESR ceramic capacitors which give added output stability. The series provides options to the user to select from a variety of circuit features, such as detector monitoring, detector output logic, EN pin input logic, and internal pull-up / down resistance (semi-custom). The IC's internal regulator circuit can be placed in stand-by mode via the EN function (XC6402C series). In the stand-by mode, power consumption is greatly reduced. The XC6402F series offers the option of a delay on the detector output: the delay time can be controlled by the use of an external capacitor.

APPLICATIONS

- CD-ROM, CD-R / RW drive
- DVD drive
- HDD drive
- Cameras, Video recorders
- Portable AV equipment
- Battery powered equipment

FEATURES

- Maximum Output Current** : More than 700mA
(800mA limit)
(1.6V $V_{ROUT(T)}$ 5.0V)
- Dropout Voltage** : 50mV @ 100mA
100mV @ 200mA
- Maximum Operating Voltage** : 1.5V ~ 6.0V
- VR Output Voltage Range** : 0.8V ~ 5.0V (50mV increments)
- VD Detect Voltage Range** : 0.8V ~ 5.0V (50mV increments)
More than 1.5V (V_{IN} sensing)
- Highly Accurate** : $\pm 2\%$
- Low Power Consumption** : 35 μ A (TYP.)
- High Ripple Rejection** : 60dB @ 1kHz
- Ambient Temperature** : - 40 ~ 85
- Low ESR Capacitor** : Ceramic capacitor compatible
- Ultra Small Packages** : SOT-25, SOT-89-5, USP-6B,
* VD: Voltage Detector

TYPICAL APPLICATIONS CIRCUITS

XC6402C Series

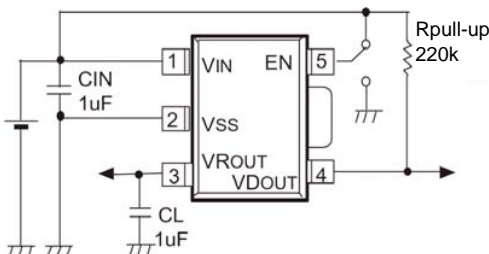

XC6402F Series

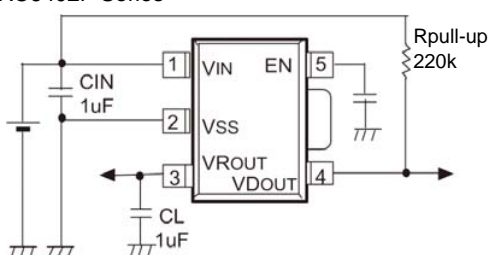

TYPICAL PERFORMANCE CHARACTERISTICS

Dropout Voltage vs. VR Output Current

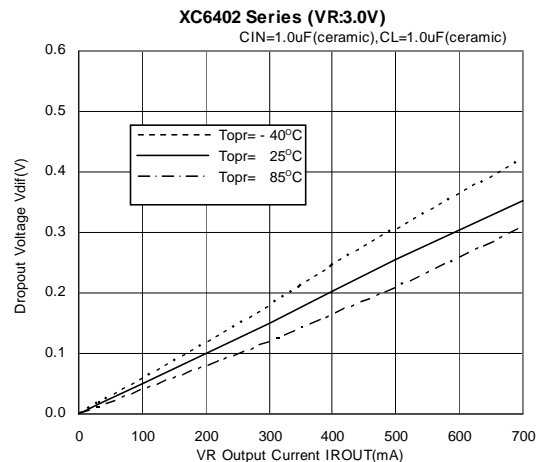

PIN CONFIGURATION

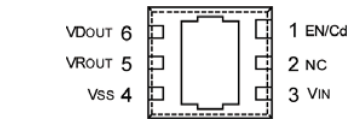
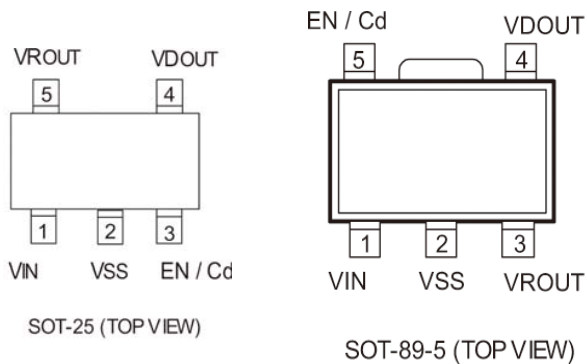

USP-6B (BOTTOM VIEW)

*The dissipation pad for the USP-6B package should be solder-plated in recommended mount pattern and metal masking so as to enhance mounting strength and heat release. If the pad needs to be connected to other pins, it should be connected to the Vss pin.

PIN ASSIGNMENT

PIN NUMBER			PIN NAME	FUNCTION
SOT-25	SOT-89-5	USP-6B		
1	1	3	VIN	Power Input
2	2	4	VSS	Ground
5	3	5	VROUT	VR Output
4	4	6	VDOUT	VD Output
3	5	1	EN	VR ON/OFF Control (C Series)
3	5	1	Cd	Delay Capacitor Connection (F Series)
-	-	2	NC	No Connection

PRODUCT CLASSIFICATION

Selection Guide

1. EN Input Logic, Internal Pull-up / down as option

SERIES	CE INPUT LOGIC
XC6402 * A ~ D	High Active with pull-down resistance
XC6402 * E ~ K	High Active with no pull-down resistance
XC6402 * L ~ P	Low Active with pull-up resistance
XC6402 * R ~ U	Low Active with no pull-up resistance

2. VD Sense as option

SERIES	VD SENSE PIN
XC6402 * A, B, E, F, L, M, R, S, V, X	VIN
XC6402 * C, D, H, K, N, P, T, U, Y, Z	VROUT

3. VD Output Logic as option

SERIES	VD OUTPUT LOGIC
XC6402 * A, C, E, H, L, N, R, T, V, Y	Detect L
XC6402 * B, D, F, K, M, P, S, U, X, Z	Detect H

PRODUCT CLASSIFICATION (Continued)

Ordering Information

XC6402 _____

DESIGNATOR	DESCRIPTION	SYMBOL	DESCRIPTION
①	Operational Function	C	: EN function
		F	: Cd Pin
②	Type of Regulator	-	: As in the chart below
③ ④	Output Voltage & Detect Voltage	-	: Internally set sequential number relating to output voltage and detect voltage. VR setting output voltage range: 0.8V ~ 5.0V Detect voltage setting range: 0.8V ~ 5.0V 50mV increments are available
⑤	Package	M	: SOT-25
		P	: SOT-89
		D	: USP-6B
⑥	Device Orientation	R	: Embossed tape, standard feed
		L	: Embossed tape, reverse feed

PIN NUMBER : Types

②	EN FUNCTION	EN LOGIC	PULL UP/DOWN RESISTANCE	VD SENSE PIN	VD OUTPUT LOGIC	PIN NUMBER ①
A	Functional	High Active	Pull-down Function	VIN	Detect L	C Series
B	Functional	High Active	Pull-down Function	VIN	Detect H	
C	Functional	High Active	Pull-down Function	VROUT	Detect L	
D	Functional	High Active	Pull-down Function	VROUT	Detect H	
E	Functional	High Active	Nonfunctional	VIN	Detect L	
F	Functional	High Active	Nonfunctional	VIN	Detect H	
H	Functional	High Active	Nonfunctional	VROUT	Detect L	
K	Functional	High Active	Nonfunctional	VROUT	Detect H	
L	Functional	Low Active	Pull-up Function	VIN	Detect L	
M	Functional	Low Active	Pull-up Function	VIN	Detect H	
N	Functional	Low Active	Pull-up Function	VROUT	Detect L	
P	Functional	Low Active	Pull-up Function	VROUT	Detect H	
R	Functional	Low Active	Nonfunctional	VIN	Detect L	
S	Functional	Low Active	Nonfunctional	VIN	Detect H	
T	Functional	Low Active	Nonfunctional	VROUT	Detect L	
U	Functional	Low Active	Nonfunctional	VROUT	Detect H	
V	Nonfunctional	-	-	VIN	Detect L	F Series
X	Nonfunctional	-	-	VIN	Detect H	
Y	Nonfunctional	-	-	VROUT	Detect L	
Z	Nonfunctional	-	-	VROUT	Detect H	

BLOCK DIAGRAMS

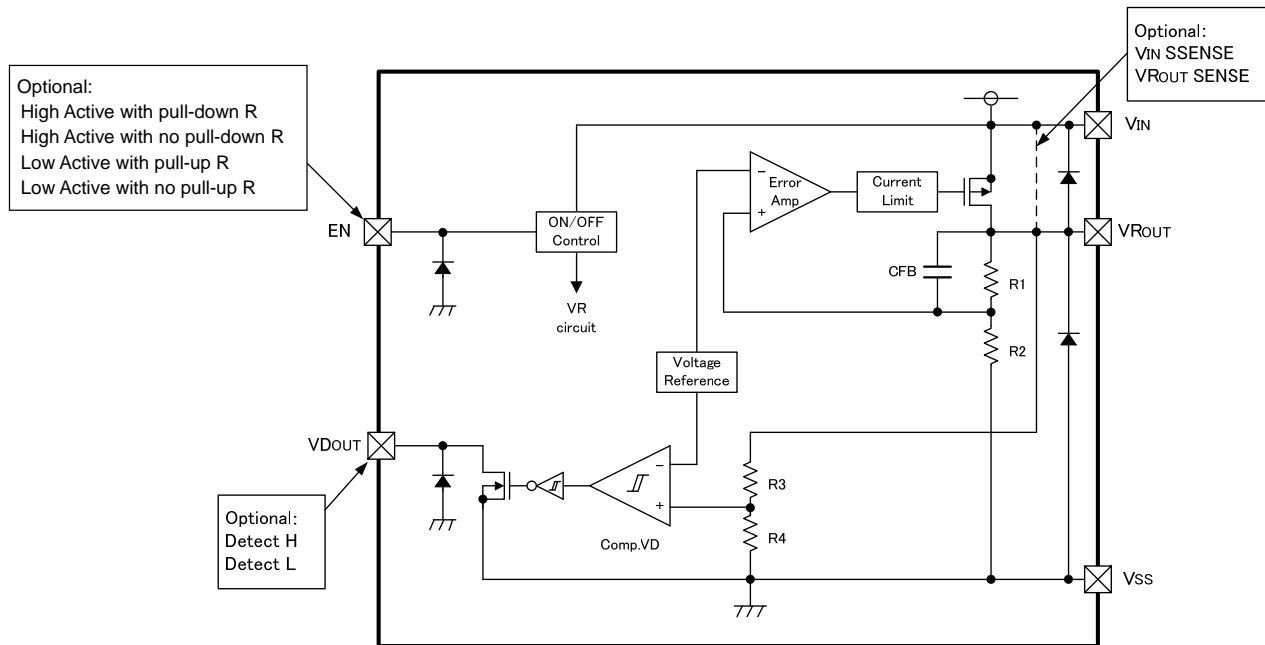

XC6402C Series

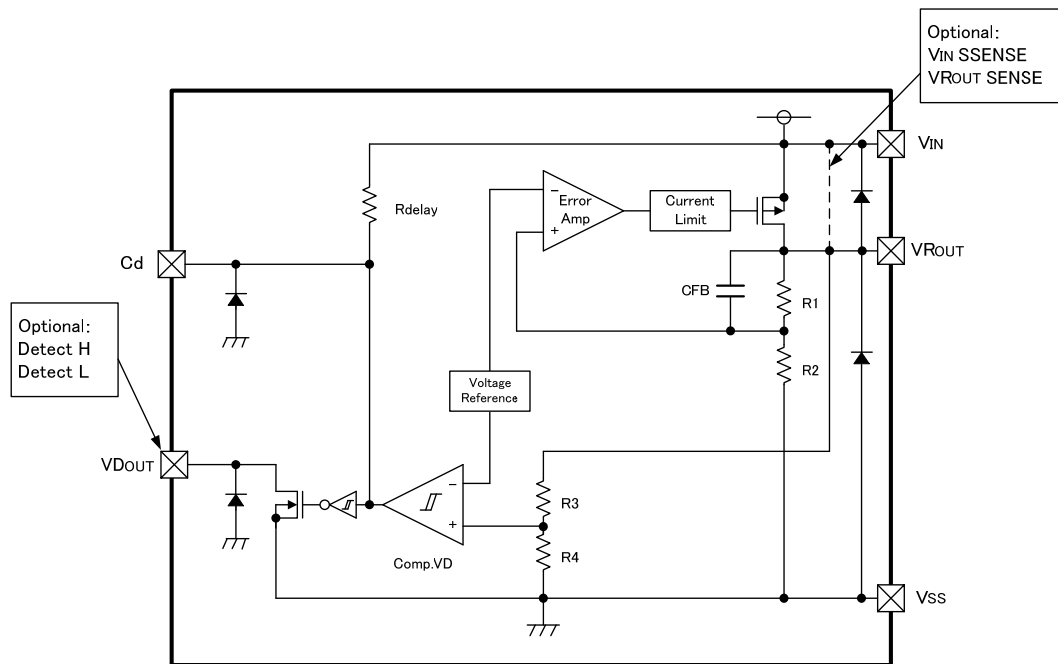

XC6402F Series

* Diodes inside the circuit are an ESD protection diode and a parasitic diode.

ABSOLUTE MAXIMUM RATINGS

Ta = 25

PARAMETER	SYMBOL	RATINGS	UNITS
Input Voltage	V _{IN}	6.5	V
VR Output Current	I _{ROUT}	800	mA
VR Output Voltage	V _{ROUT}	V _{SS} -0.3 ~ V _{IN} +0.3	V
VD Output Current	I _{DOUT}	50	mA
VD Output Voltage	V _{DOUT}	V _{SS} -0.3 ~ 6.5	V
EN / Cd Pin Voltage	V _{EN} / Cd	V _{SS} -0.3 ~ 6.5	V
Power Dissipation	SOT-25	250	mW
	SOT-89-5	500	
	USP-6B	100	
Operating Temperature Range	T _{opr}	- 40 ~ + 85	
Storage Temperature Range	T _{stg}	- 55 ~ + 125	

ELECTRICAL CHARACTERISTICS

XC6402C Series

Ta=25

	PARAMETER	SYMBOL	CONDITIONS	MIN.	TYP.	MAX.	UNITS	CIRCUIT
VOLTAGE REGULATOR	Output Voltage (*2, 3)	V _{ROUT(E)}	V _{IN} =V _{ROUT(T)} +1.0V, I _{ROUT} =30mA	× 0.98 (-30m)	V _{ROUT(T)}	× 1.02 (+30mV)	V	
	Maximum Output Current [V _{ROUT(E)} 1.6V]	I _{ROUTMAX}	V _{IN} =V _{ROUT(T)} +1.0V V _{EN} =ON(V _{IN} or V _{SS})	700	-	-	mA	
	Maximum Output Current [V _{ROUT(E)} < 1.6V]	I _{ROUTMAX}	V _{IN} =V _{ROUT(T)} +1.0V V _{EN} =ON(V _{IN} or V _{SS})	500	-	-	mA	
	Load Regulation	V _{ROUT}	1mA I _{ROUT} 100mA	-	15	60	mV	
	Dropout Voltage (*4)	V _{dif1}	I _{ROUT} =30mA	E-1		mV		
		V _{dif2}	I _{ROUT} =100mA	E-2				
	Supply Current (CA/CB/CC/CD type)	I _{DD}	V _{EN} =V _{IN} =V _{ROUT(T)} +1.0V, I _{ROUT} =0mA	E-3		μA		
	Supply Current (CL/CM/CN/CP type)	I _{DD}	V _{IN} =V _{ROUT(T)} +1.0V, V _{EN} =V _{SS} , I _{ROUT} =0mA	E-3		μA		
	Supply Current (CE/CF/CH/CK type)	I _{DD}	V _{EN} =V _{IN} =V _{ROUT(T)} +1.0V, I _{ROUT} =0mA	-	35	70	μA	
	Supply Current (CR/CS/CT/CU type)	I _{DD}	V _{IN} =V _{ROUT(T)} +1.0V, V _{EN} =V _{SS} , I _{ROUT} =0mA	-	35	70	μA	
	Line Regulation	$\frac{V_{ROUT}}{V_{IN} \cdot V_{ROUT}}$	V _{ROUT(T)} +1.0V V _{IN} 6.0V V _{EN} =ON(V _{IN} or V _{SS}), I _{ROUT} =30mA	-	0.01	0.20	%/V	
	Input Voltage	V _{IN}		1.5	-	6.0	V	-
	Output Voltage Temperature Characteristics	$\frac{V_{ROUT}}{T_{opr} \cdot V_{ROUT}}$	I _{ROUT} =30mA -40 T _{opr} 85	-	± 100	-	ppm /	
	Ripple Rejection Rate	PSRR	V _{IN} =[V _{ROUT(T)} +1.0]V _{DC} +0.5V _{p-pAC} When V _{ROUT(T)} 4.75V V _{IN} =5.75V+0.5V _{p-pAC} I _{ROUT} =30mA, f=1kHz	-	60	-	dB	
	Current Limiter [V _{ROUT(E)} 1.6V]	I _{Rlim}	V _{IN} = V _{ROUT(T)} +1.0V V _{EN} =ON(V _{IN} or V _{SS})	700	800	-	mA	
Current Limiter [V _{ROUT(E)} < 1.6V]	I _{Rlim}	V _{IN} = V _{ROUT(T)} +1.0V V _{EN} =ON(V _{IN} or V _{SS})	-	800	-	mA		
Short-Circuit Current	I _{Rshort}	V _{IN} = V _{ROUT(T)} +1.0V V _{EN} =ON(V _{IN} or V _{SS})	-	30	-	mA		

ELECTRICAL CHARACTERISTICS (Continued)

XC6402C Series (Continued)

Ta=25

	PARAMETER	SYMBOL	CONDITIONS	MIN.	TYP.	MAX.	UNITS	CIRCUIT	
VOLTAGE DETECTOR	Detect Voltage (*7, 8)	VDF(E)		× 0.98 (-30mV)	VDF(T)	× 1.02 (+30mV)	V		
	Hysteresis Range (*7)	VHYS		VDF(E) × 0.02	VDF(E) × 0.05	VDF(E) × 0.08	V		
	Supply Current	IDDVD	VEN = OFF (VIN or VSS)	VIN = 1.5V	-	5.0	14.0	μA	
				VIN = 2.0V	-	5.5	14.5		
				VIN = 3.0V	-	6.0	15.0		
				VIN = 4.0V	-	6.5	15.5		
				VIN = 5.0V	-	7.0	16.0		
Output Current (*9)	IDOUT	VDOUT = 0.5V	VIN = 1.5V	1.5	3.0	-	mA		
			VIN = 2.0V	1.8	3.5	-			
			VIN = 3.0V	1.8	3.7	-			
			VIN = 4.0V	1.9	3.8	-			
			VIN = 5.0V	1.9	3.9	-			
Detect Voltage Temperature Characteristics	$\frac{VDF}{T_{opr} \cdot VDF}$	-40 Topr 85		-	± 100	-	ppm /		
SWITCH	EN "High" Level Voltage	VENH		1.30	-	VIN	V		
	EN "Low" Level Voltage	VENL		-	-	0.25	V		
	EN "High" Level Current (CA/CB/CC/CD type)	IENH	VEN=VIN=VROUT(T)+1.0V	-0.10	-	E-4	μA		
	EN "High" Level Current (CE/CF/CH/CK/CL/CM/CN/CP/CR/CS/CT/CU type)	IENH		-0.10	-	0.10	μA		
	EN "High" Level Current (CL/CM/CN/CP type)	IENL	VIN=VROUT(T)+1.0V, VEN=VSS	E-5	-	0.10	μA		
	EN "High" Level Current (CA/CB/CC/CD/CE/CF/CH/CK/CR/CS/CT/CU type)	IENL	VIN=VROUT(T)+1.0V, VEN=VSS	-0.10	-	0.10	μA		

NOTE:

- *1: Unless otherwise stated, VIN=VROUT(T)+1.0V
- *2: VROUT(T)=Specified VR output voltage
- *3: VROUT(E)=Effective VR output voltage.
(i.e. the VR output voltage when "VROUT(T)+1.0V" is provided at the VIN pin while maintaining a certain IROUT value).
- *4: $V_{dif} = (V_{IN1}^{(6)} - V_{ROUT1}^{(5)})$
- *5: A voltage equal to 98% of the VR output voltage whenever a stabilized VROUT1=IROUT{VROUT(T)+1.0V} is input.
- *6: VIN1=The input voltage when VOUT1, which appears as input voltage is gradually decreased.
- *7: VDF(T) : Specified detect voltage value
- *8: VDF(E) : Effective detect voltage value.
- *9: VD output current value of detect 'L' type equal to current value during detection and that of Detect 'H' type equal to current value before detection.
- *10: VROUT(T) 1.45V, VDF(T) 1.45V
MIN : VROUT(T) -30mV, VDF(T) -30mV,
MAX : VROUT(T) +30mV, VDF(T) +30mV
- *11: EN conditions: XC6402CZ / CB / CC / CD / CE / CF / CH / CK type: ON=VIN, OFF=VSS
XC6402CL / CM / CN / CP / CR / CS / CT / CU type: ON=VSS, OFF=VIN
- *12: VD detect voltage: For VIN sense version, XC6402CA / CB / CE / CF / CL / CM / CR / CS, only VDF(T) 1.5V type are available.

ELECTRICAL CHARACTERISTICS (Continued)

XC6402F Series

Ta=25

	PARAMETER	SYMBOL	CONDITIONS	MIN.	TYP.	MAX.	UNITS	CIRCUIT
VOLTAGE REGULATOR	Output Voltage (*2, 3)	V _{ROUT(E)}	V _{IN} =V _{ROUT(T)} +1.0V, I _{ROUT} =30mA	× 0.98 (-30mV)	V _{ROUT(T)}	× 1.02 (+30mV)	V	
	Maximum Output Current [V _{ROUT(E)} 1.6V]	I _{ROUTMAX}	V _{IN} = V _{ROUT(T)} +1.0V	700	-	-	mA	
	Maximum Output Current [V _{ROUT(E)} < 1.6V]	I _{ROUTMAX}	V _{IN} = V _{ROUT(T)} +1.0V	500	-	-	mA	
	Load Regulation	V _{ROUT}	1mA I _{ROUT} 100mA	-	15	60	mV	
	Dropout Voltage (*4)	V _{dif1}	I _{ROUT} =30mA	E-1			mV	
		V _{dif2}	I _{ROUT} =100mA	E-2				
	Supply Current	I _{DD}	V _{IN} = V _{ROUT(T)} +1.0V	-	35	70	μA	
	Line Regulation	$\frac{V_{ROUT}}{V_{IN} \cdot V_{ROUT}}$	V _{ROUT(T)} +1.0V V _{IN} 6.0V I _{ROUT} =30mA	-	0.01	0.20	%/V	
	Input Voltage	V _{IN}		1.5	-	6.0	V	-
	Output Voltage Temperature Characteristics	$\frac{V_{ROUT}}{Topr \cdot V_{ROUT}}$	I _{ROUT} =30mA -40 Topr 85	-	± 100	-	ppm/	
	Ripple Rejection Rate	PSRR	V _{IN} =[V _{ROUT(T)} +1.0]VDC+0.5V _{p-p} AC When V _{ROUT(T)} 4.75V V _{IN} =5.75V+0.5V _{p-p} AC I _{ROUT} =30mA, f=1kHz	-	60	-	dB	
	Current Limiter [V _{ROUT(E)} 1.6V]	I _{Rlim}	V _{IN} =V _{ROUT(T)} +1.0V	700	800	-	mA	
	Current Limiter [V _{ROUT(E)} < 1.6V]	I _{Rlim}	V _{IN} =V _{ROUT(T)} +1.0V	-	800	-	mA	
Short-Circuit Current	I _{Rshort}	V _{IN} =V _{ROUT(T)} +1.0V	-	30	-	mA		
VOLTAGE DETECTOR	Detect Voltage (*7, 8)	V _{DF(E)}		× 0.98 (-30mV)	V _{DF(T)}	× 1.02 (+30mV)	V	
	Hysteresis Range (*7)	V _{HYS}		V _{DF(E)} × 0.02	V _{DF(E)} × 0.05	V _{DF(E)} × 0.08	V	
	Output Current (*9)	I _{DOUT}	V _{DOUT} =0.5V	V _{IN} = 1.5V	1.5	3.0	-	mA
				V _{IN} = 2.0V	1.8	3.5	-	
				V _{IN} = 3.0V	1.8	3.7	-	
				V _{IN} = 4.0V	1.9	3.8	-	
				V _{IN} = 5.0V	1.9	3.9	-	
Detect Voltage Temperature Characteristics	$\frac{V_{DF}}{Topr \cdot V_{DF}}$	-40 Topr 85	-	± 100	-	ppm/		
Delay Resistance	R _{delay}	V _{IN} =6.0V, V _{CD} =0V	1.0	2.0	3.5	M		

NOTE:

- *1: Unless otherwise stated, V_{IN}=V_{ROUT(T)}+1.0V
- *2: V_{ROUT(T)}=Specified VR output voltage
- *3: V_{ROUT(E)}=Effective VR output voltage.
(i.e. the VR output voltage when "V_{ROUT(T)}+1.0V" is provided at the V_{IN} pin while maintaining a certain I_{ROUT} value).
- *4: V_{dif}={V_{IN1}⁽⁶⁾ - V_{ROUT1}^{(5)}}
- *5: A voltage equal to 98% of the VR output voltage whenever a stabilized V_{ROUT1}=I_{ROUT}{V_{ROUT(T)}+1.0V} is input.
- *6: V_{IN1}=The input voltage when V_{OUT1}, which appears as input voltage is gradually decreased.
- *7: V_{DF(T)} : Specified detect voltage value
- *8: V_{DF(E)} : Effective detect voltage value.
- *9: VD output current value of Detect 'L' type equal to current value during detection and that of Detect 'H' type equal to current value before detection.
- *10: V_{ROUT(T)} 1.45V, V_{DF(T)} 1.45V
MIN: V_{ROUT(T)} -30mV, V_{DF(T)} -30mV,
MAX: V_{ROUT(T)} +30mV, V_{DF(T)} +30mV
- *11: VD detect voltage: For V_{IN} Sense version, XC6402FV / FX, only V_{DF(T)}>1.5V type are available.

ELECTRICAL CHARACTERISTICS (Continued)

Dropout Voltage, Supply Current, EN'H/L' Level Current

XC6402C Series

SETTING OUTPUT VOLTAGE (V)	VR OUTPUT VOLTAGE VD DETECT VOLTAGE (V)		E-1		E-2		E-3		E-4	E-5						
			DROPOUT VOLTAGE 1 (mV)		DROPOUT VOLTAGE 2 (mV)		SUPPLY CURRENT (μ A)		EN'H'LEVEL CURRENT (μ A)	EN'H'LEVEL CURRENT (μ A)						
	VOUT		Vdif1		Vdif2		IDD		IENH	IENL						
VROUT(T)	MIN.	MAX.	TYP.	MAX.	TYP.	MAX.	TYP.	MAX.	MAX.	MIN.						
0.80	0.770	0.830	100	700	250	800	38.0	80.0	5.0	-5.0						
0.85	0.820	0.880		600		700										
0.90	0.870	0.930		50		500					600					
0.95	0.920	0.980				400					500					
1.00	0.970	1.030	30	300	100	400	38.5	81.5	6.5	-6.5						
1.05	1.020	1.080		200		300										
1.10	1.070	1.130		27.0		41.0					90.0	135.0	39.0	83.0	8.0	-8.0
1.15	1.120	1.180														
1.20	1.170	1.230														
1.25	1.220	1.280														
1.30	1.270	1.330	25.0	37.0	80.0	120.0	39.5	84.5	9.5	-9.5						
1.35	1.320	1.380														
1.40	1.370	1.430														
1.45	1.420	1.480														
1.50	1.470	1.530														
1.55	1.519	1.581														
1.60	1.568	1.632														
1.65	1.617	1.683														
1.70	1.666	1.734														
1.75	1.715	1.785														
1.80	1.764	1.836														
1.85	1.813	1.887														
1.90	1.862	1.938														
1.95	1.911	1.989														
2.00	1.960	2.040	18.0	28.0	60.0	90.0	40.0	86.0	11.0	-11.0						
2.05	2.009	2.091														
2.10	2.058	2.142														
2.15	2.107	2.193														
2.20	2.156	2.244														
2.25	2.205	2.295														
2.30	2.254	2.346														
2.35	2.303	2.397														
2.40	2.352	2.448														
2.45	2.401	2.499														
2.50	2.450	2.550														
2.55	2.499	2.601														
2.60	2.548	2.652														
2.65	2.597	2.703														
2.70	2.646	2.754														
2.75	2.695	2.805														
2.80	2.744	2.856														
2.85	2.793	2.907														
2.90	2.842	2.958														
2.95	2.891	3.009														

ELECTRICAL CHARACTERISTICS (Continued)

Dropout Voltage, Supply Current, EN'H/L' Level Current (Continued)

XC6402C Series (Continued)

SETTING OUTPUT VOLTAGE (V)	VR OUTPUT VOLTAGE VD DETECT VOLTAGE (V)		E-1		E-2		E-3		E-4	E-5
	V _{OUT}		DROPOUT VOLTAGE 1 (mV) V _{dif1}		DROPOUT VOLTAGE 2 (mV) V _{dif2}		SUPPLY CURRENT (μ A) I _{DD}		EN'H'LEVEL CURRENT (μ A) I _{ENH}	EN'H'LEVEL CURRENT (μ A) I _{ENL}
	V _{ROUT(T)}	MIN.	MAX.	TYP.	MAX.	TYP.	MAX.	TYP.	MAX.	MAX.
3.00	2.940	3.060	15.0	23.0	50.0	75.0	40.5	87.5	12.5	-12.5
3.05	2.989	3.111								
3.10	3.038	3.162								
3.15	3.087	3.213								
3.20	3.136	3.264								
3.25	3.185	3.315								
3.30	3.234	3.366								
3.35	3.283	3.417								
3.40	3.332	3.468								
3.45	3.381	3.519								
3.50	3.430	3.570								
3.55	3.479	3.621								
3.60	3.528	3.672								
3.65	3.577	3.723								
3.70	3.626	3.774								
3.75	3.675	3.825								
3.80	3.724	3.876								
3.85	3.773	3.927								
3.90	3.882	3.978								
3.95	3.871	4.029								
4.00	3.920	4.080								
4.05	3.969	4.131								
4.10	4.018	4.182								
4.15	4.067	4.233								
4.20	4.116	4.284								
4.25	4.165	4.335								
4.30	4.214	4.386								
4.35	4.263	4.437								
4.40	4.312	4.488								
4.45	4.361	4.539								
4.50	4.410	4.590								
4.55	4.459	4.641								
4.60	4.508	4.692								
4.65	4.557	4.743								
4.70	4.606	4.794								
4.75	4.655	4.845								
4.80	4.704	4.896								
4.85	4.753	4.947								
4.90	4.802	4.998								
4.95	4.851	5.049								
5.00	4.900	5.100								

ELECTRICAL CHARACTERISTICS (Continued)

Dropout Voltage

XC6402F Series

SETTING OUTPUT VOLTAGE (V)	VR OUTPUT VOLTAGE VD DETECT VOLTAGE (V)		E-1 DROPOUT VOLTAGE 1 (mV)		E-2 DROPOUT VOLTAGE 2 (mV)	
	V _{OUT}		V _{dif1}		V _{dif2}	
	MIN.	MAX.	TYP.	MAX.	TYP.	MAX.
0.80	0.770	0.830	100	700	250	800
0.85	0.820	0.880				
0.90	0.870	0.930		600		700
0.95	0.920	0.980				
1.00	0.970	1.030	50	500	150	600
1.05	1.020	1.080				
1.10	1.070	1.130		400		500
1.15	1.120	1.180				
1.20	1.170	1.230	30	300	100	400
1.25	1.220	1.280				
1.30	1.270	1.330		200		300
1.35	1.320	1.380				
1.40	1.370	1.430	100	250		
1.45	1.420	1.480				
1.50	1.470	1.530	27.0	41.0	90.0	135.0
1.55	1.519	1.581				
1.60	1.568	1.632				
1.65	1.617	1.683				
1.70	1.666	1.734				
1.75	1.715	1.785				
1.80	1.764	1.836				
1.85	1.813	1.887				
1.90	1.862	1.938				
1.95	1.911	1.989				
2.00	1.960	2.040	25.0	37.0	80.0	120.0
2.05	2.009	2.091				
2.10	2.058	2.142				
2.15	2.107	2.193				
2.20	2.156	2.244				
2.25	2.205	2.295				
2.30	2.254	2.346				
2.35	2.303	2.397				
2.40	2.352	2.448				
2.45	2.401	2.499				
2.50	2.450	2.550	18.0	28.0	60.0	90.0
2.55	2.499	2.601				
2.60	2.548	2.652				
2.65	2.597	2.703				
2.70	2.646	2.754				
2.75	2.695	2.805				
2.80	2.744	2.856				
2.85	2.793	2.907				
2.90	2.842	2.958				
2.95	2.891	3.009				

ELECTRICAL CHARACTERISTICS (Continued)

Dropout Voltage (Continued)

XC6402F Series (Continued)

SETTING OUTPUT VOLTAGE VOLTAGE (V)	VR OUTPUT VOLTAGE VD DETECT VOLTAGE (V)		E-1 DROPOUT VOLTAGE 1 (mV)		E-2 DROPOUT VOLTAGE 2 (mV)	
	V _{OUT}		V _{dif1}		V _{dif2}	
	V _{ROUT(T)}	MIN.	MAX.	TYP.	MAX.	TYP.
3.00	2.940	3.060	15.0	23.0	50.0	75.0
3.05	2.989	3.111				
3.10	3.038	3.162				
3.15	3.087	3.213				
3.20	3.136	3.264				
3.25	3.185	3.315				
3.30	3.234	3.366				
3.35	3.283	3.417				
3.40	3.332	3.468				
3.45	3.381	3.519				
3.50	3.430	3.570				
3.55	3.479	3.621				
3.60	3.528	3.672				
3.65	3.577	3.723				
3.70	3.626	3.774				
3.75	3.675	3.825				
3.80	3.724	3.876				
3.85	3.773	3.927				
3.90	3.882	3.978				
3.95	3.871	4.029				
4.00	3.920	4.080				
4.05	3.969	4.131				
4.10	4.018	4.182				
4.15	4.067	4.233				
4.20	4.116	4.284				
4.25	4.165	4.335				
4.30	4.214	4.386				
4.35	4.263	4.437				
4.40	4.312	4.488				
4.45	4.361	4.539				
4.50	4.410	4.590				
4.55	4.459	4.641				
4.60	4.508	4.692				
4.65	4.557	4.743				
4.70	4.606	4.794				
4.75	4.655	4.845				
4.80	4.704	4.896				
4.85	4.753	4.947				
4.90	4.802	4.998				
4.95	4.851	5.049				
5.00	4.900	5.100				

TEST CIRCUITS

XC6402C Series

Circuit

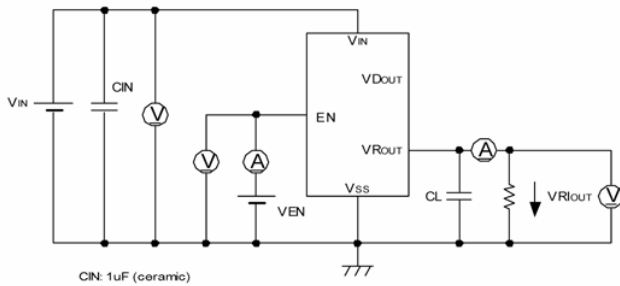

Circuit

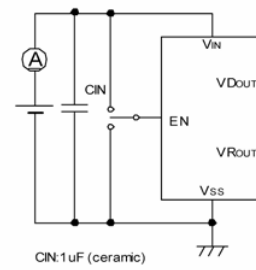

Circuit

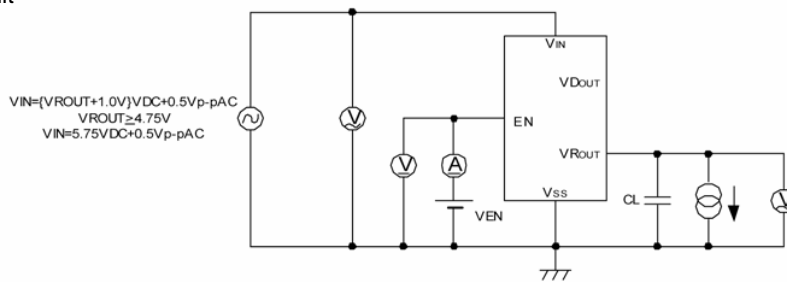

Circuit

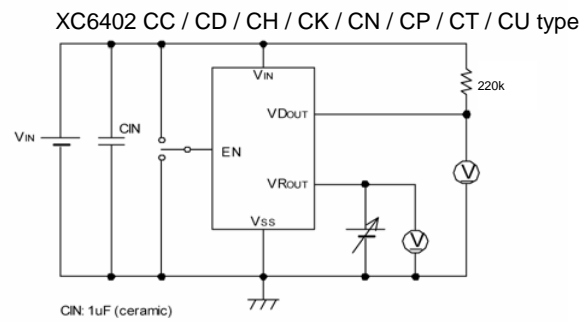
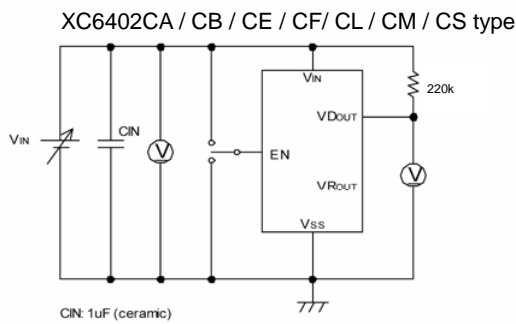

Circuit

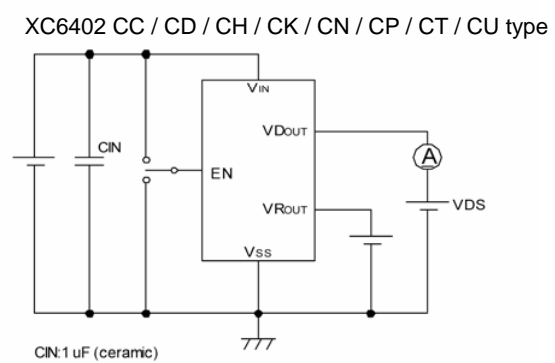
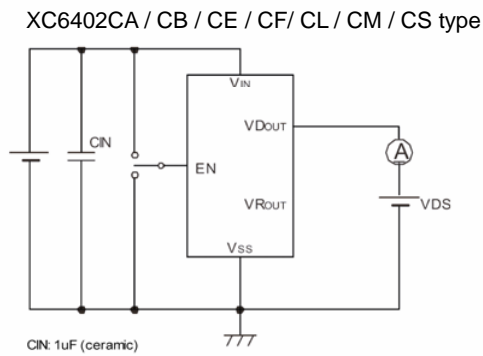

Output Capacitor Corresponding Chart

VR OUTPUT VOLTAGE	0.8 ~ 1.45V	1.5 ~ 1.75V	1.8V ~ 5.0V
CL	6.8 μ F	2.2 μ F	1.0 μ F

TEST CIRCUITS (Continued)

XC6402F Series

Circuit

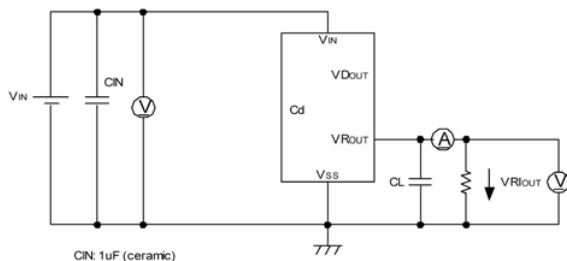

Circuit

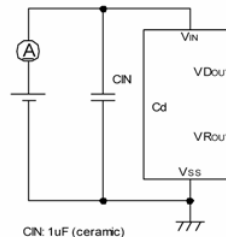

Circuit

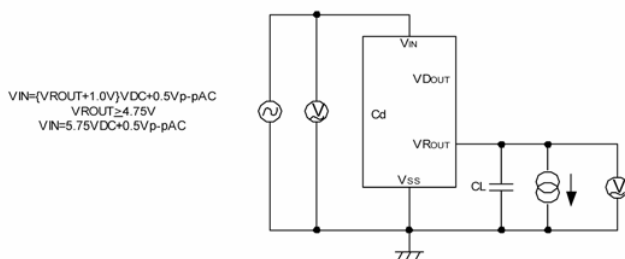

Circuit

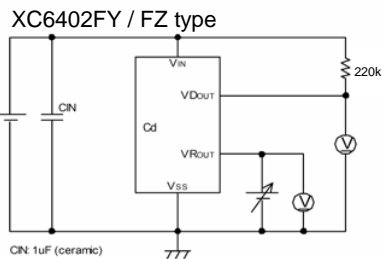
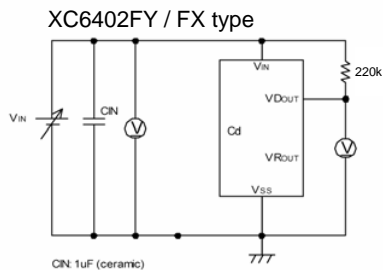

Circuit

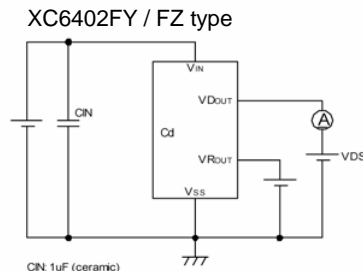
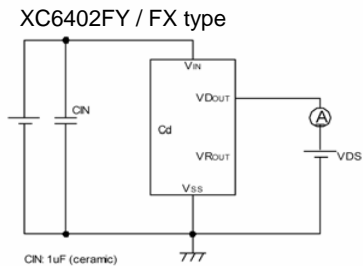

Circuit

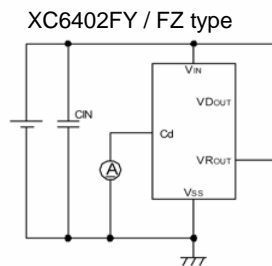
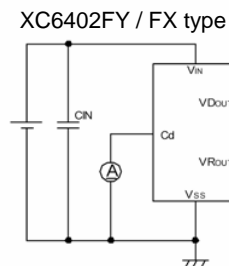

Output Capacitor Corresponding Chart

VR OUTPUT VOLTAGE	0.8 ~ 1.45V	1.5 ~ 1.75V	1.8V ~ 5.0V
CL	6.8 μ F	2.2 μ F	1.0 μ F

OPERATIONAL EXPLANATION

<Output Voltage Regulator Control>

The voltage, divided by resistors R1 & R2 which are connected to the VROUT pin is compared with the internal reference voltage by the error amplifier. The P-channel MOSFET, which is connected to the VROUT pin, is then driven by the subsequent output signal. The output voltage at the VROUT pin is controlled & stabilized by negative feedback. The current limit circuit and short circuit protection operate in relation to the level of output current. Further, the voltage regulator's internal circuitry can be shutdown via the EN pin's signal.

<Detector Function with the XC6402 Series>

The series' detector function monitors the voltage divided by resistors R3 & R4 which are connected to the VROUT pin or the VIN pin, as well as monitoring the voltage of the internal reference voltage source via the comparator.

The VDSEN pin has options (please refer to the Selection Guide, item 2).

A 'High' or 'Low' signal level can be output from the VDOUT pin when the VD pin voltage level goes below the detect voltage. The VD output logic has options (please refer to the Selection Guide, item 3). As VDOUT is an open-drain N-channel output, a pull-up resistor of about 220k is needed to achieve a voltage output. Because of hysteresis at the detector function, output at the VDOUT pin will invert when the detect voltage level increases above the release voltage (105% of the detect voltage).

For the XC6402C type, in stand-by, if a voltage of the recovery voltage is present at the VROUT pin (from another power source), the VDOUT pin will be high impedance mode, and the pull up voltage will be output at VDOUT. By connecting the Cdelay pin to a capacitor (Cd), the XC6402F series can apply a delay time to VDOUT voltage when releasing voltage. The delay time can be calculated from the internal resistance, Rdelay (2M TYP. fixed) and the value of Cd as per the following equation.

$$\text{Delay Time} = C_{\text{delay}} \times R_{\text{delay}} \times 0.7$$

Delay Time	Rdelay standard : 1.0 ~ 3.5M	TYP : 2.0M
Cdelay	DELAY TIME (TYP.)	DELAY TIME
0.01 μ F	14 ms	7.0 ~ 24.5 ms
0.022 μ F	30.8 ms	15.4 ~ 53.9 ms
0.047 μ F	65.8 ms	32.9 ~ 115.15 ms
0.1 μ F	140 ms	70.0 ~ 245.0 ms
0.22 μ F	308 ms	154.0 ~ 539.0 ms
0.47 μ F	658 ms	329.0 ~ 1151.5 ms
1 μ F	1400 ms	700.0 ~ 2450.0 ms

<Low ESR Capacitors>

With the XC6402 series regulator, a stable output voltage is achievable even if low ESR capacitors are used, as a phase compensation circuit is built-in to the regulator. In order to ensure the effectiveness of the phase compensation, we suggest that an output capacitor (CL) be connected as close as possible, between the output pin (VROUT) and the VSS pin. Please use an output capacitor (CL) with a capacitance, based on the chart below. We also suggest an input capacitor (CIN) of 1 μ F : this should be connected between VIN and VSS in order to stabilize input power source.

Output Capacitor Corresponding Chart

VR OUTPUT VOLTAGE	0.8 ~ 1.45V	1.5 ~ 1.75V	1.8V ~ 5.0V
CL	6.8 μ F	2.2 μ F	1.0 μ F

<Current Limiter, Short-Circuit Protection>

The XC6402 series regulator offers a combination of current limit and circuit protection by means of a built-in fixed current limiter circuit and a foldback circuit. When the load current reaches the current limit level, the fixed current limiter circuit operates and output voltage drops. As a result of this drop in output voltage, the foldback circuit operates, the output voltage drops further and output current decreases. When the output pin is shorted, a current of about 30mA flows.

OPERATIONAL EXPLANATION (Continued)

<EN Pin>

The IC's internal regulator circuitry can be shut down via the signal from the EN pin with the XC6402C series. In shutdown mode, output at the VROUT pin will be pulled down to the VSS level via R1 & R2. Note that as the XC6402*E to K types of the XC6402C series are 'High Active / No Pull-Down' and XC6402*R to U types of the XC6402C series are 'Active LOW / No Pull-Up', operations will become unstable with the EN pin open (See the chart below).

SERIES	EN INPUT LOGIC
XC6402C A ~ D	High Active with pull-down resistor
XC6402C E ~ K	High Active with no pull-down resistor
XC6402C L ~ P	Low Active with pull-up resistor
XC6402C R ~ U	Low Active with no pull-up resistor

We suggest that you use this IC with either a V_{IN} voltage or a V_{SS} voltage input at the EN pin. If this IC is used with the correct specifications for the EN pin, the IC will operate normally. However, supply current may increase as a result of through current in the IC's internal circuitry if a voltage other than V_{IN} or V_{SS} is applied.

NOTES ON USE

1. Please use this IC within the stated absolute maximum ratings. The IC is liable to malfunction should the ratings be exceeded.
2. Where wiring impedance is high, operations may become unstable due to noise and/or phase lag depending on output current. Please strengthen V_{IN} and V_{SS} wiring in particular.
3. Please wire the input capacitor (C_{IN}) and the output capacitor (C_L) as close to the IC as possible.
Should rapid input fluctuation or load fluctuation occur, please increase the capacitor value such as C_{IN} or C_L to stabilize the operation.

TYPICAL PERFORMANCE CHARACTERISTICS

(1) VR Output Voltage vs. VR Output Current

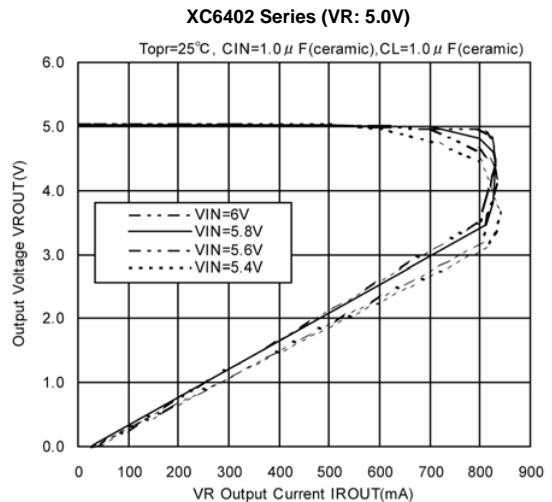
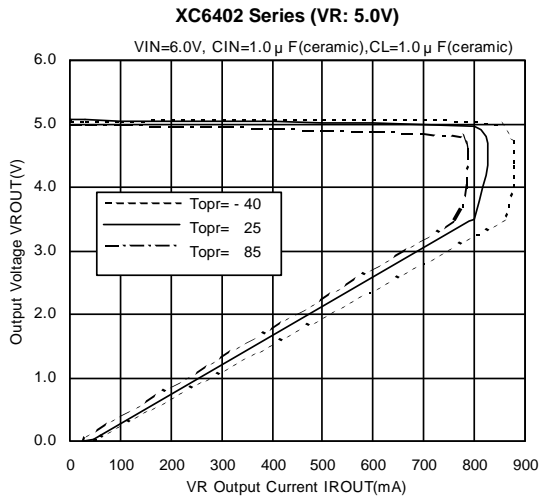
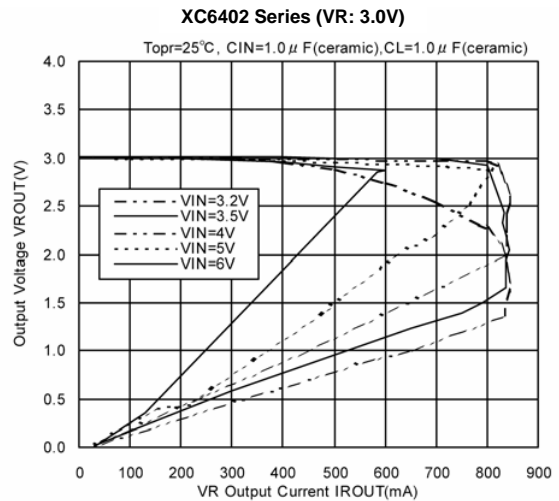
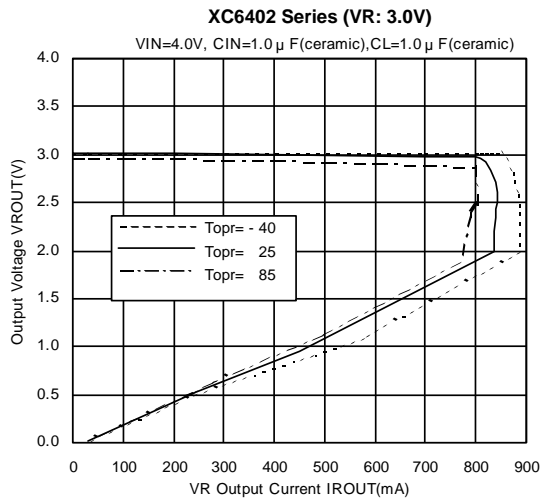
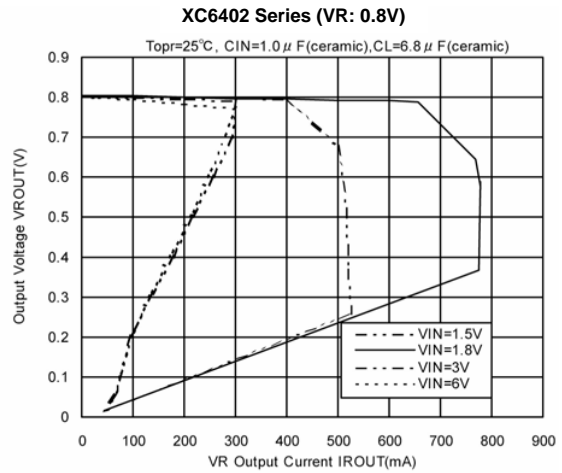
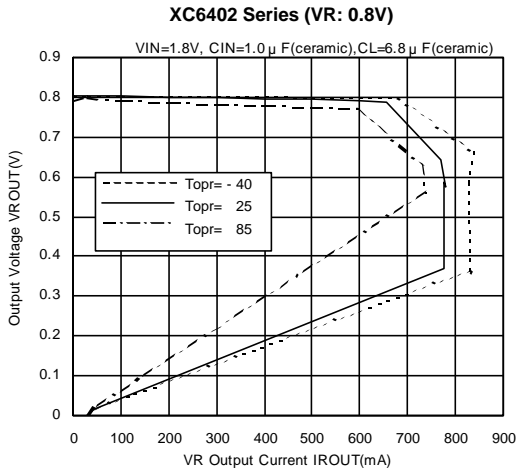

TYPICAL PERFORMANCE CHARACTERISTICS (Continued)

(2) VR Output Voltage vs. Input Voltage

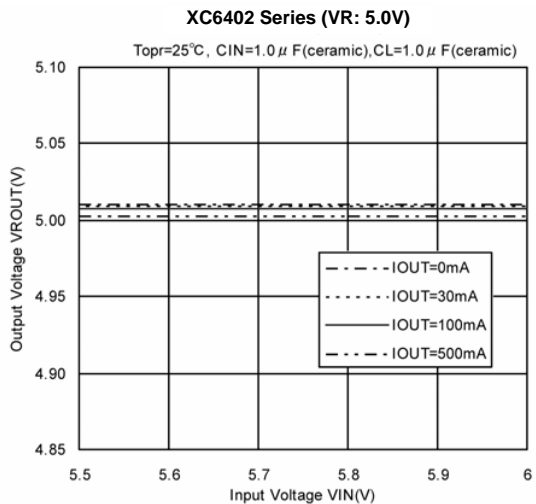
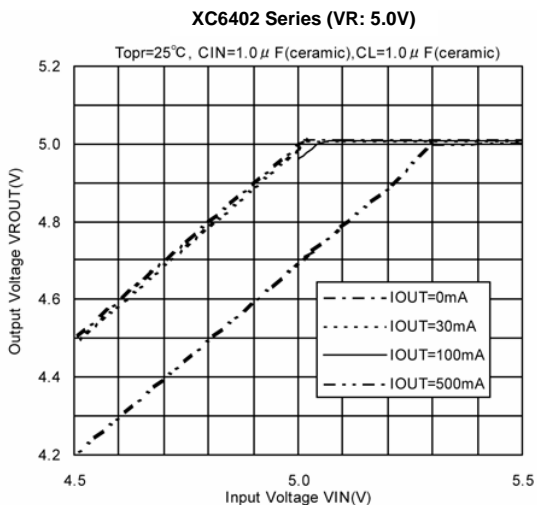
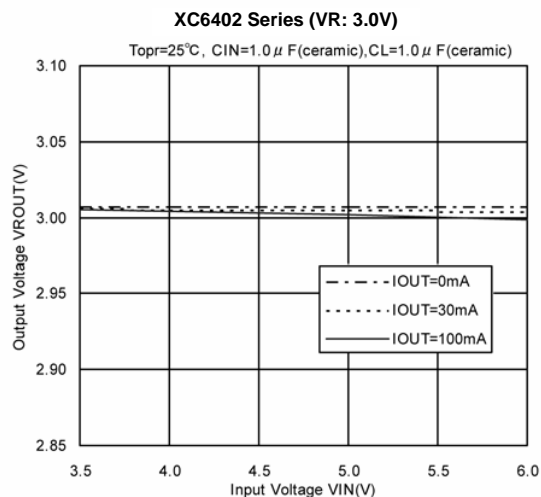
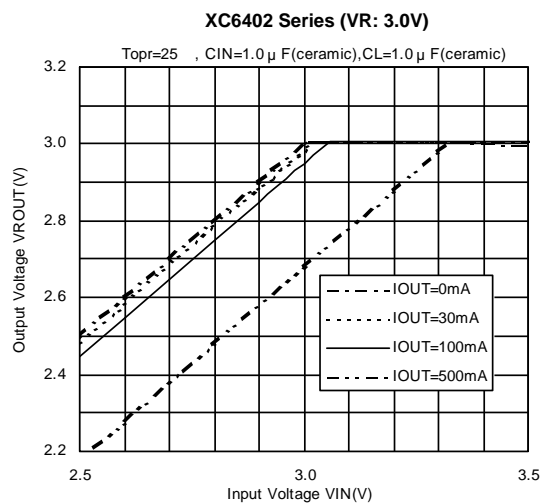
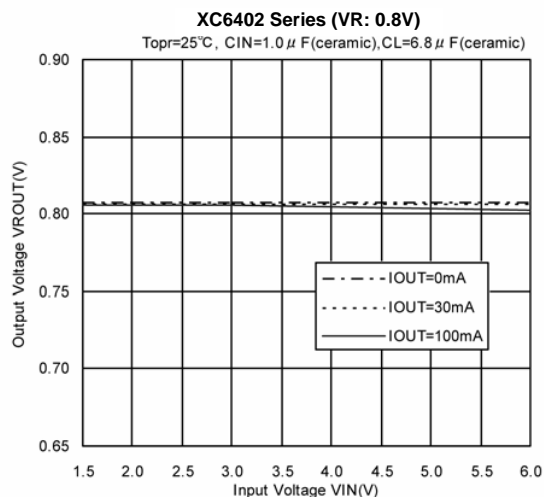
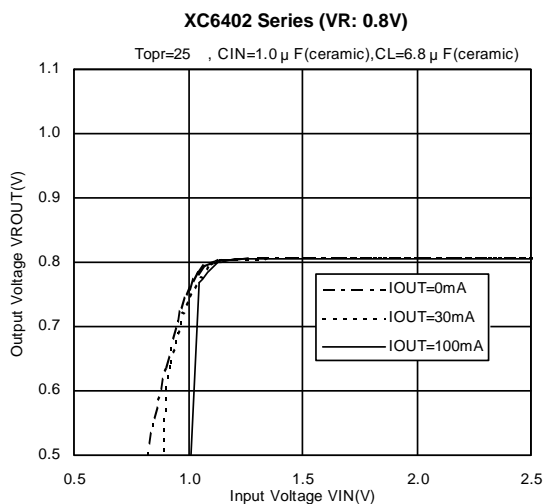

TYPICAL PERFORMANCE CHARACTERISTICS (Continued)

(3) Dropout Voltage vs. Output Current

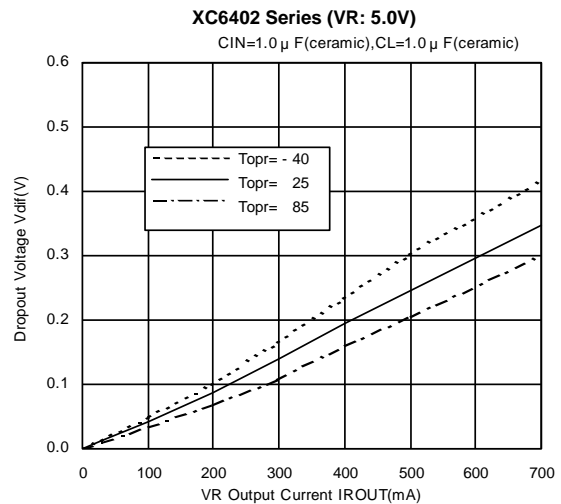
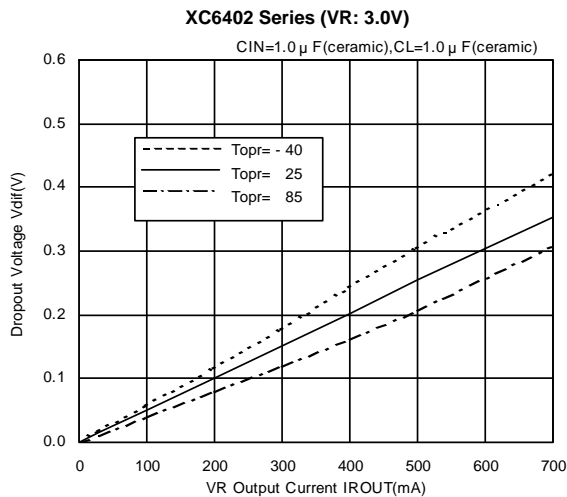
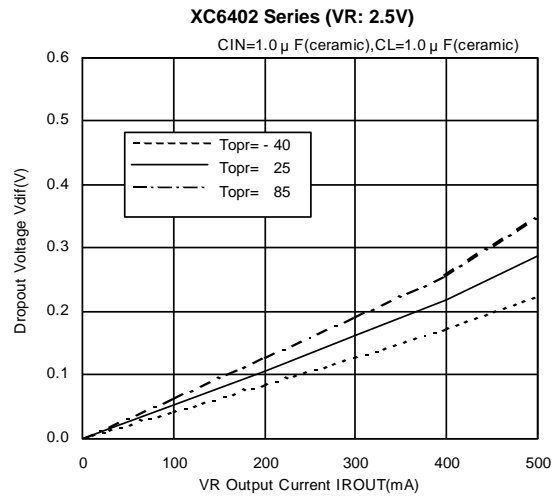
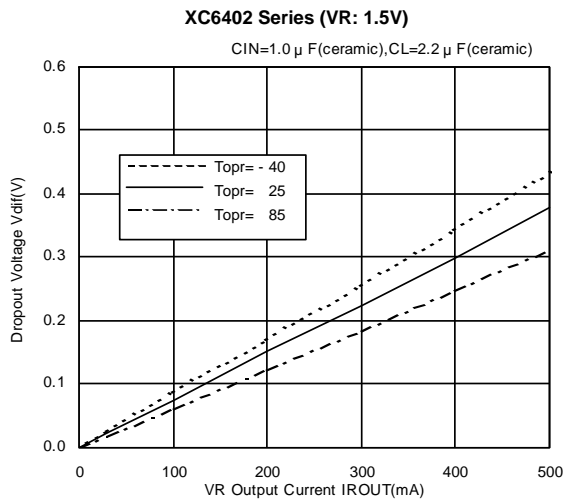
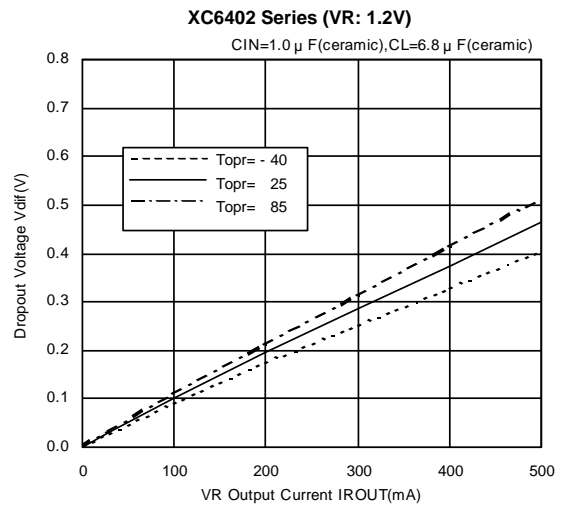
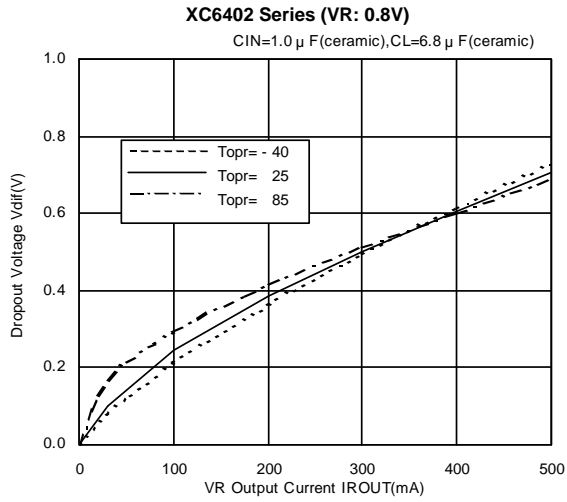

TYPICAL PERFORMANCE CHARACTERISTICS (Continued)

(4) Supply Current vs. Input Voltage

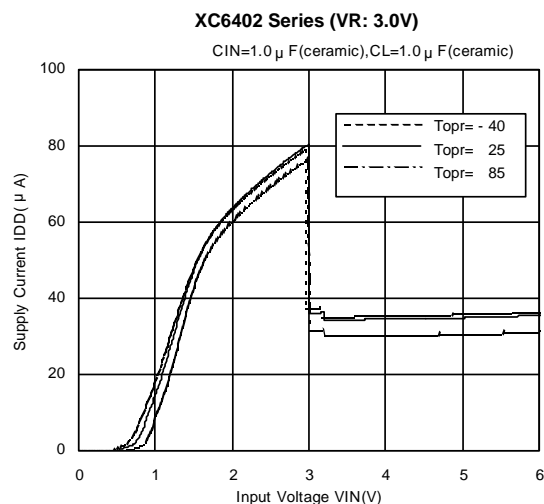
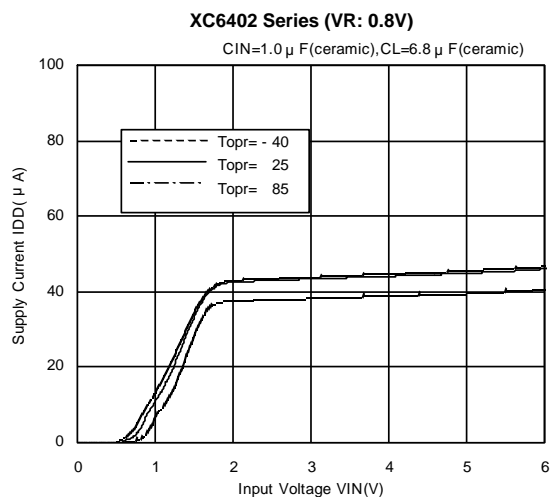

(5) VR Output Voltage vs. Operating Temperature

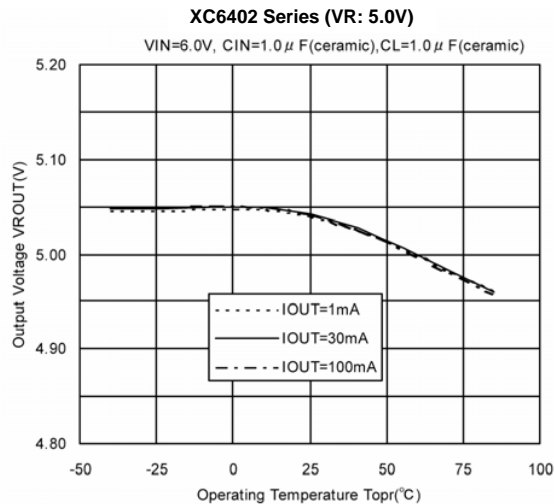
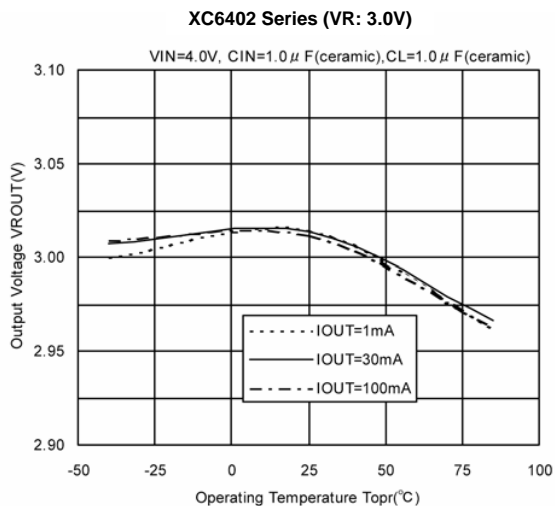
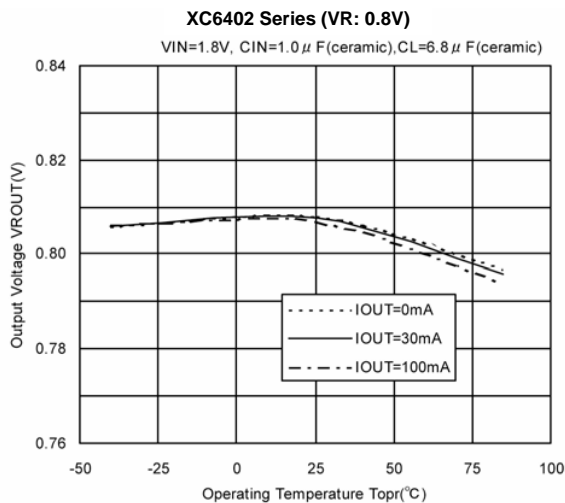
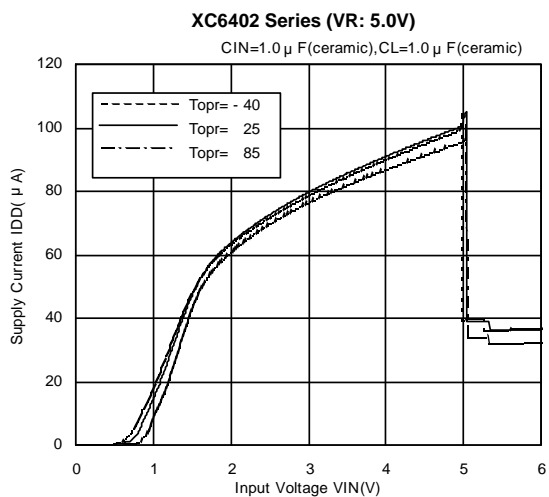

TYPICAL PERFORMANCE CHARACTERISTICS (Continued)

(6) Supply Current vs. Operating Temperature

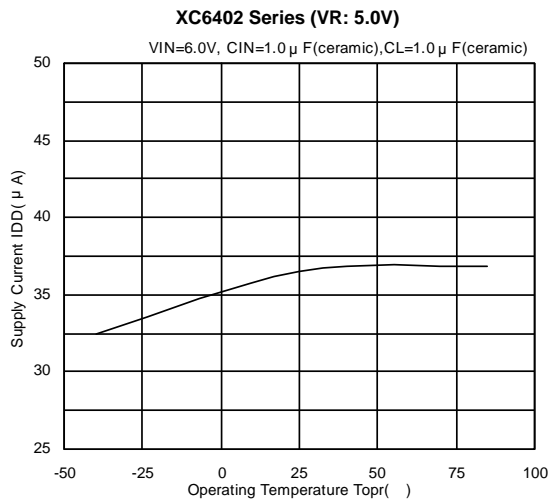
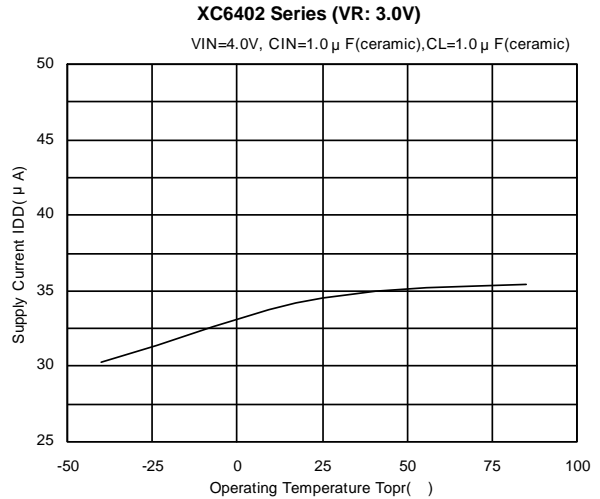
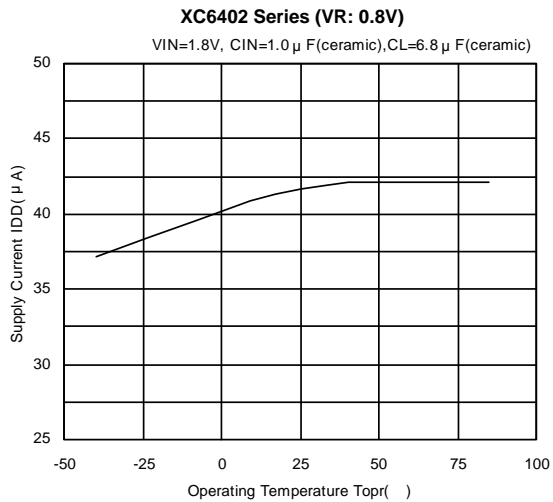

(7) EN Threshold Voltage vs. Operating Temperature (For C Series only)

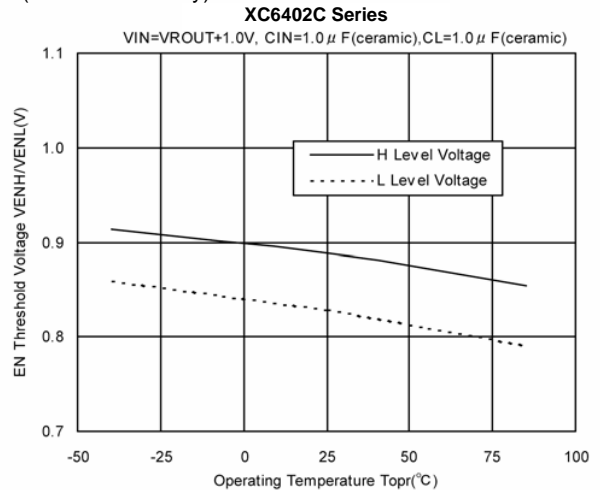

(8) Rdelay vs. Operating Temperature (For F Series only)

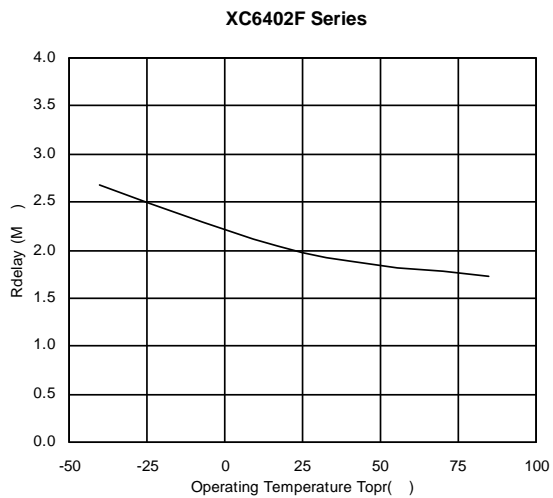

TYPICAL PERFORMANCE CHARACTERISTICS (Continued)

(9) VD Supply Current vs. Input Voltage (For C Series only)

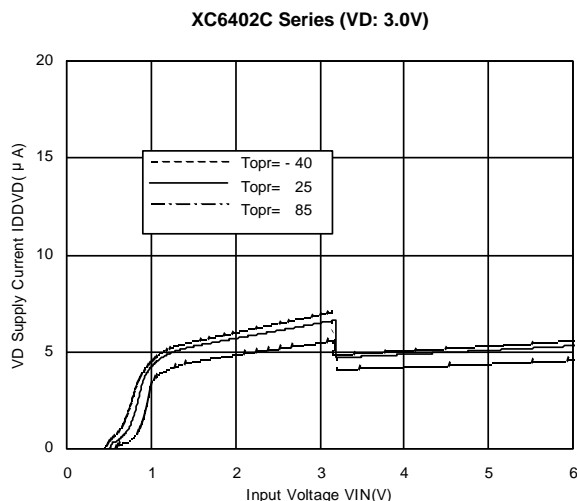
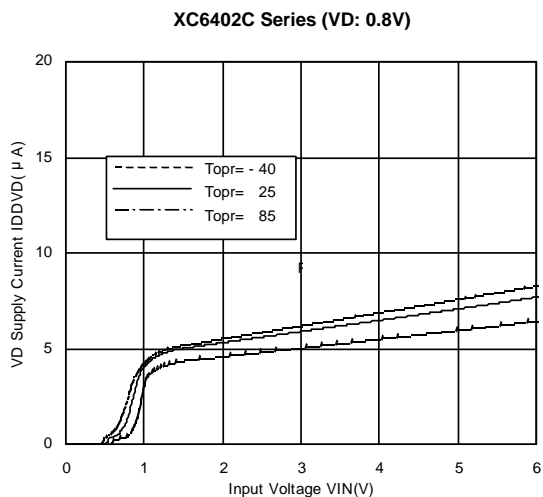

(10) Detect Voltage & Release Voltage vs. Operating Temperature

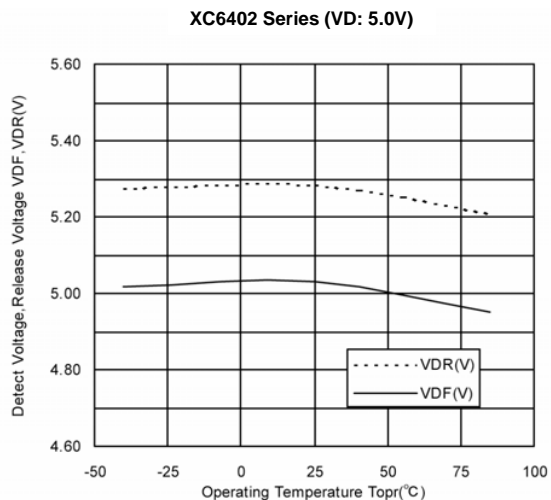
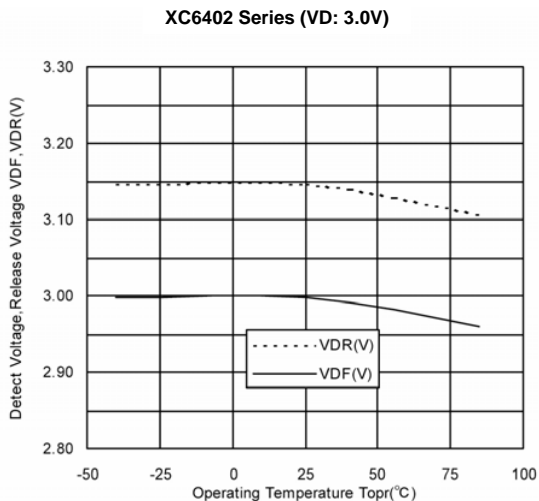
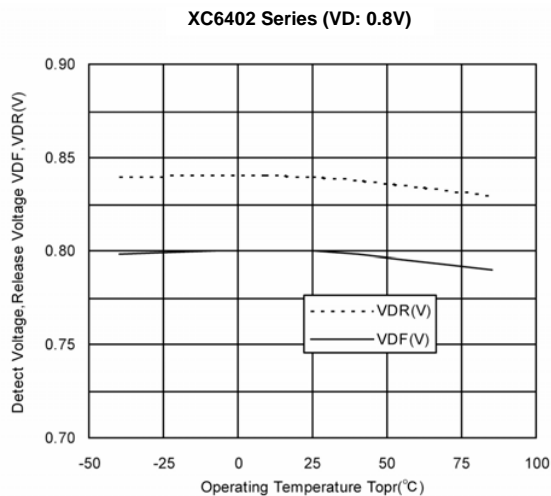
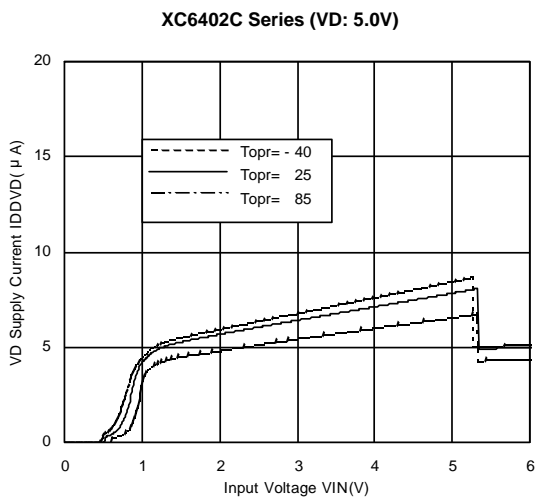

TYPICAL PERFORMANCE CHARACTERISTICS (Continued)

(11) VD N-ch Driver Tr. Output Current vs. Vds

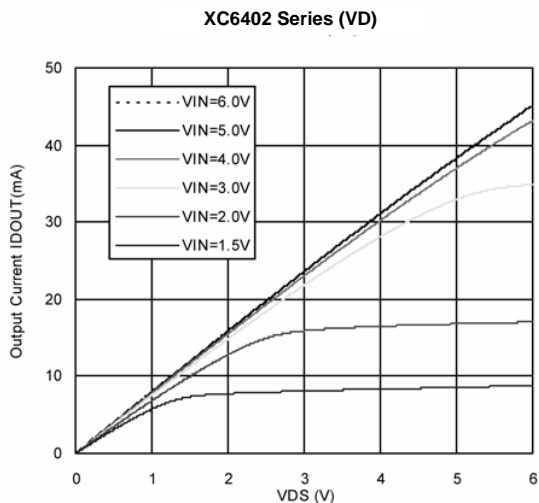

(12) VD N-ch Driver Tr. Output Current vs. Input Voltage

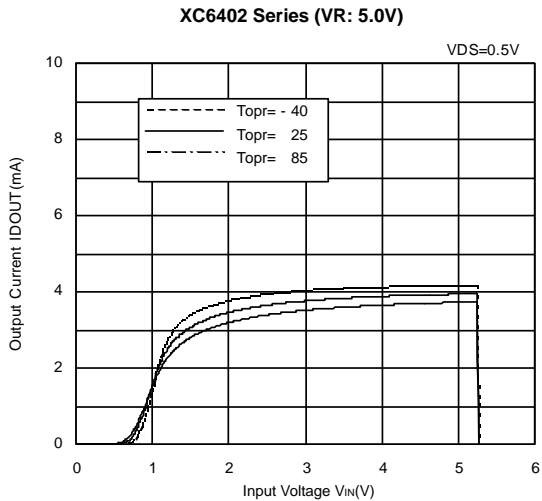
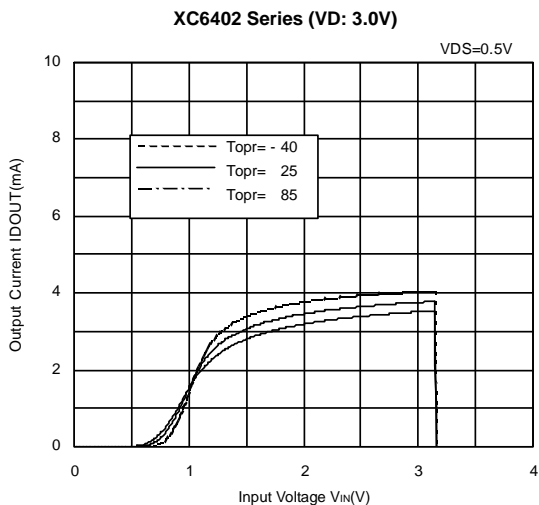
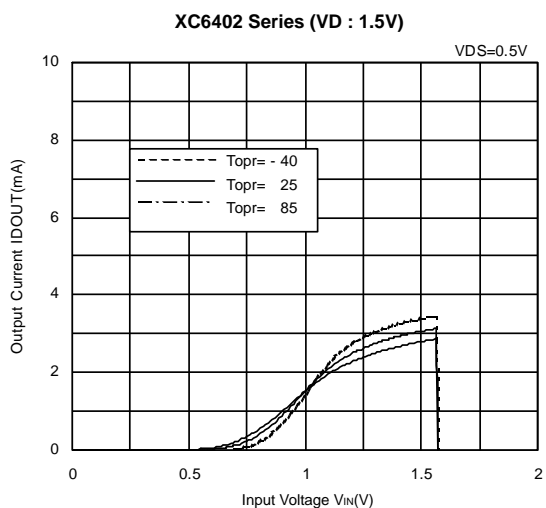

TYPICAL PERFORMANCE CHARACTERISTICS (Continued)

(13) VR Input Transient Response

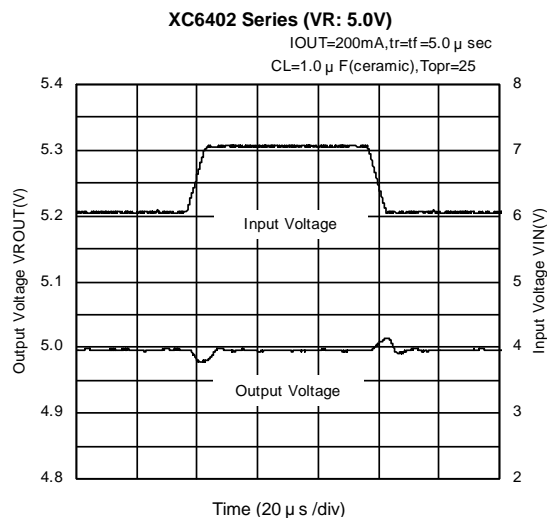
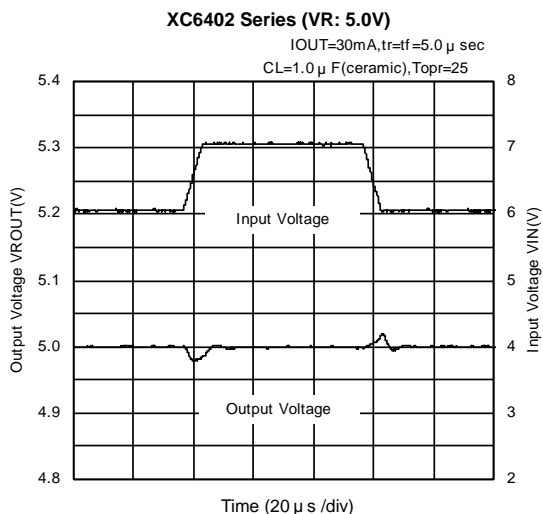
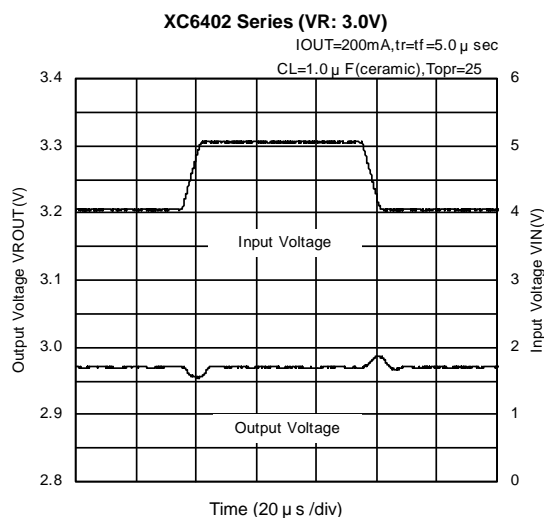
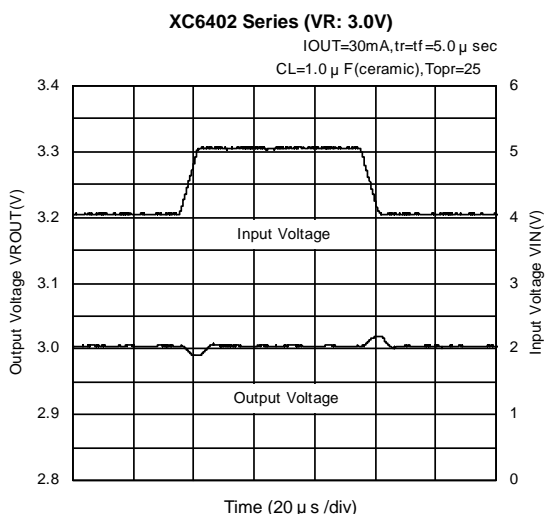
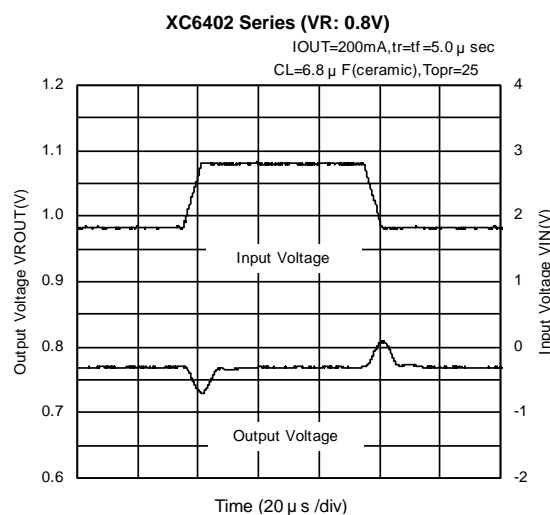
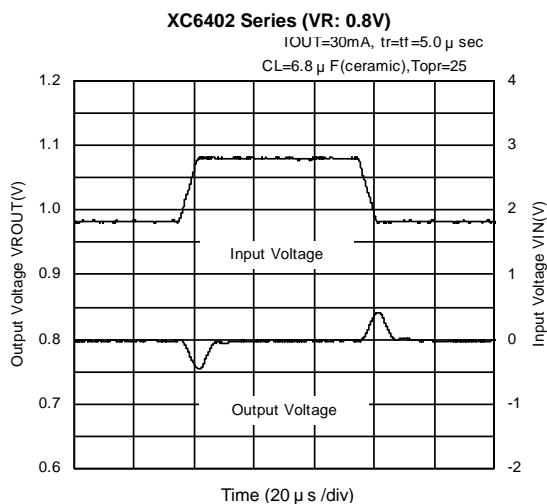

TYPICAL PERFORMANCE CHARACTERISTICS (Continued)

(14) VR Load Transient Response

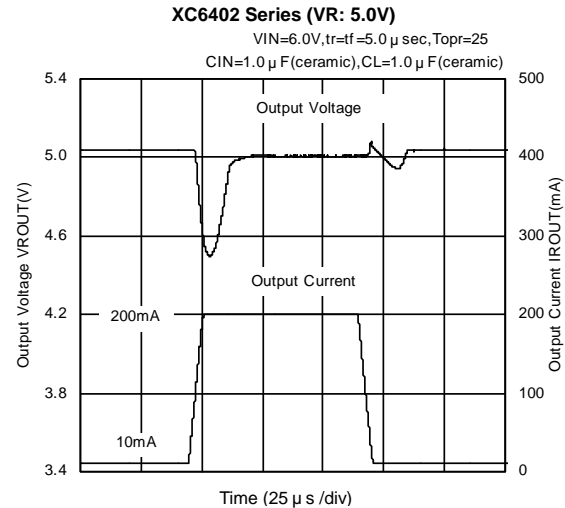
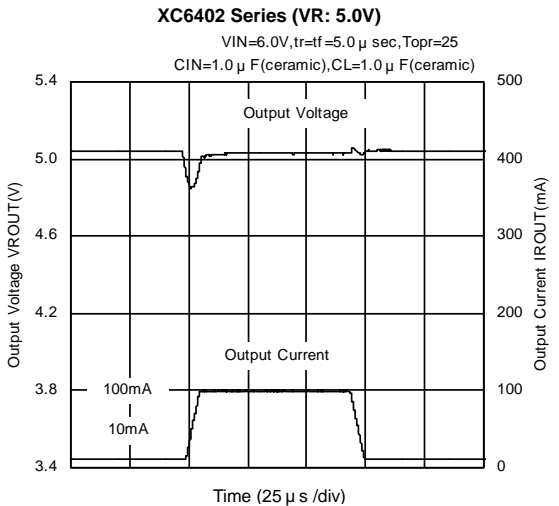
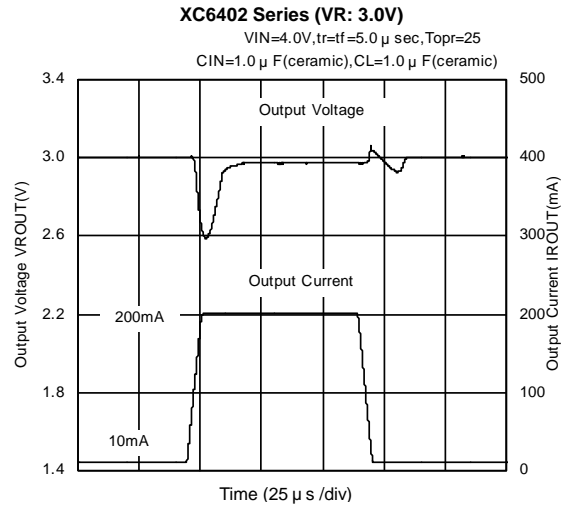
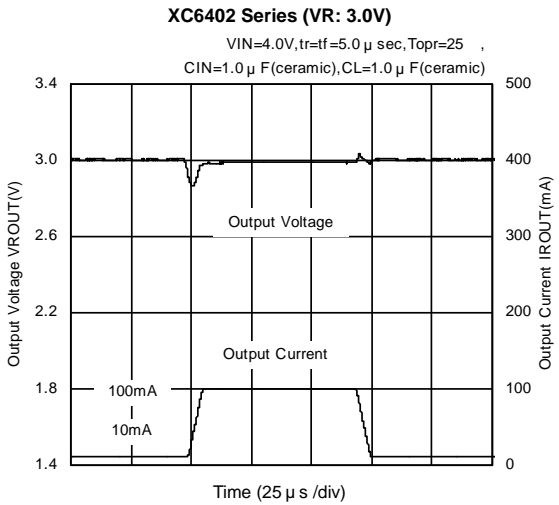
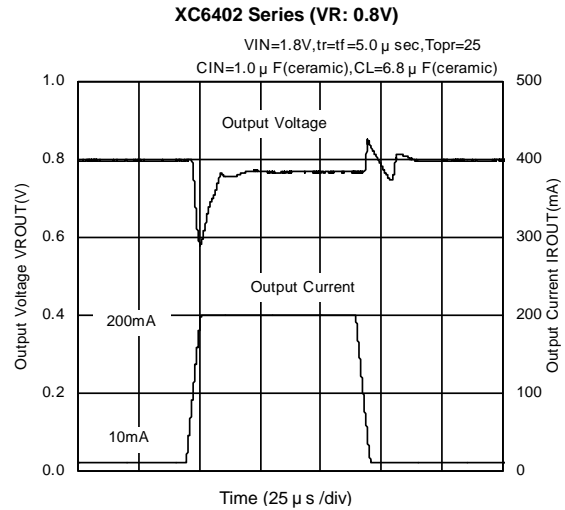
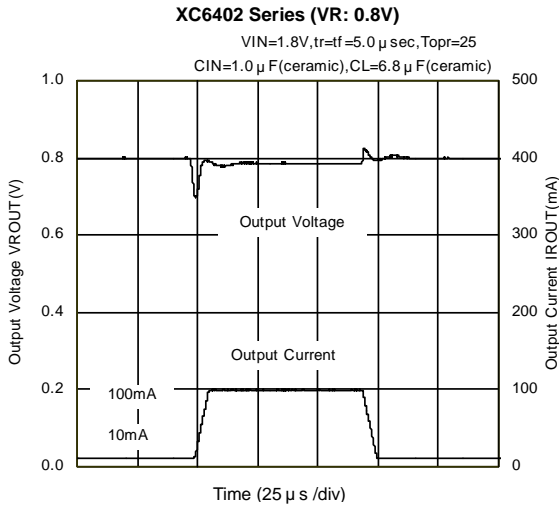

TYPICAL PERFORMANCE CHARACTERISTICS (Continued)

(15) Ripple Rejection Rate

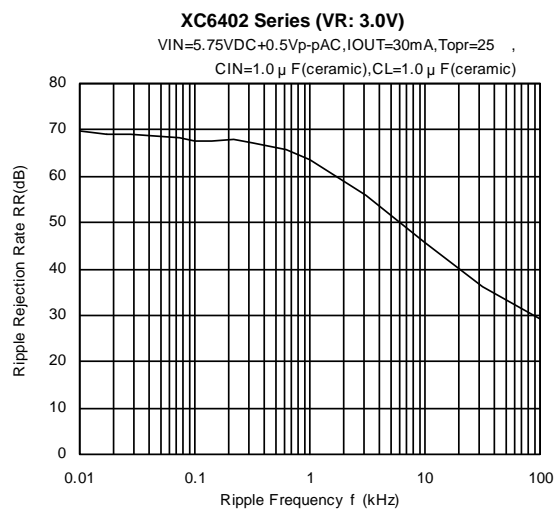
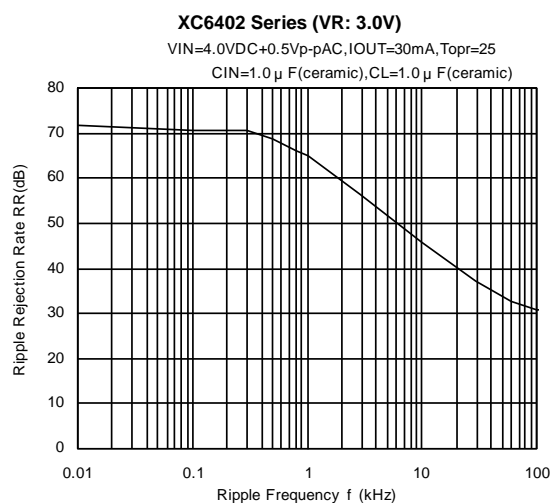
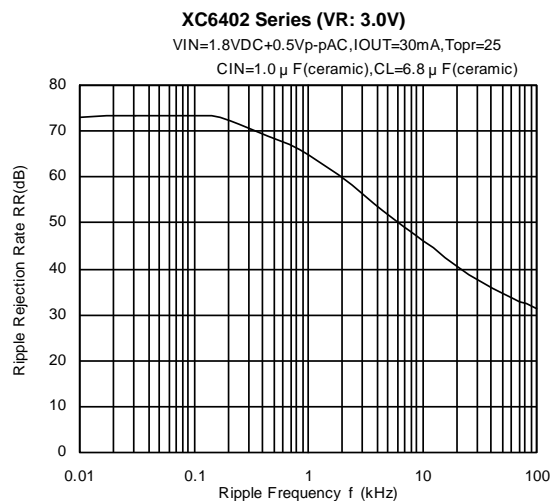

TYPICAL PERFORMANCE CHARACTERISTICS (Continued)

(16) Rising Response Time

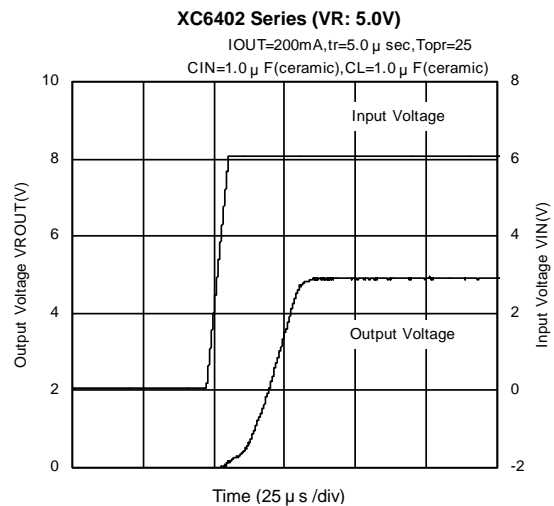
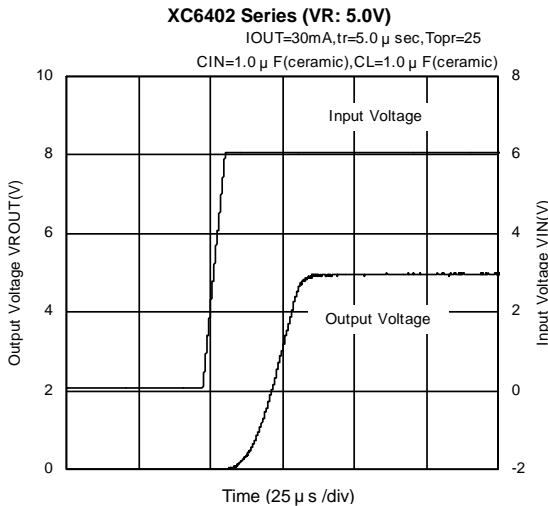
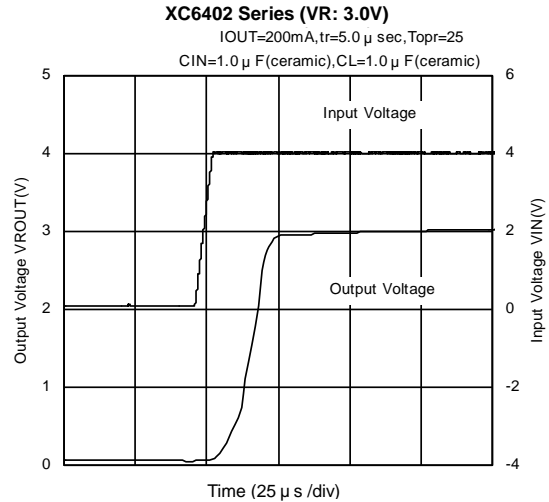
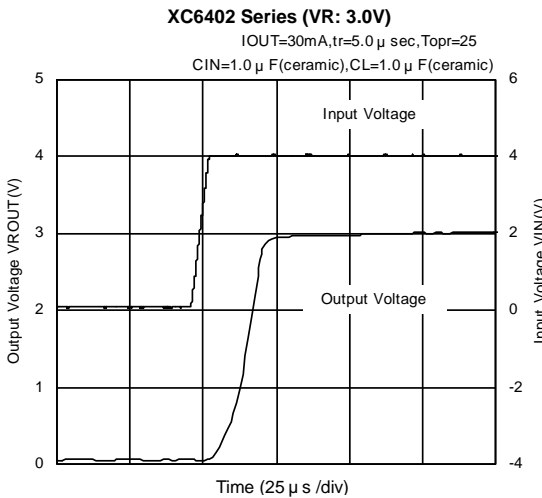
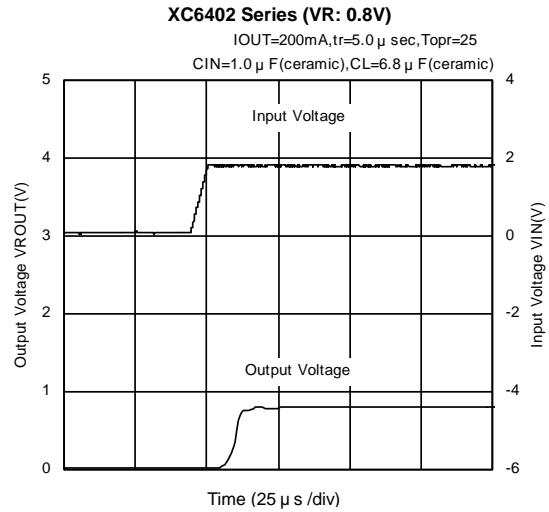
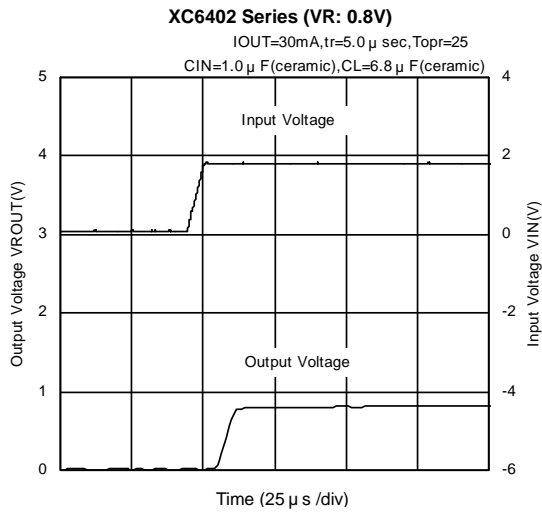

TYPICAL PERFORMANCE CHARACTERISTICS (Continued)

(17) EN Rising Response Time (For C Series only)

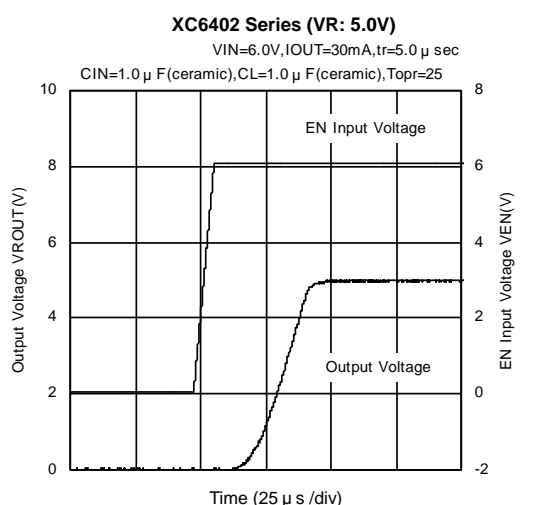
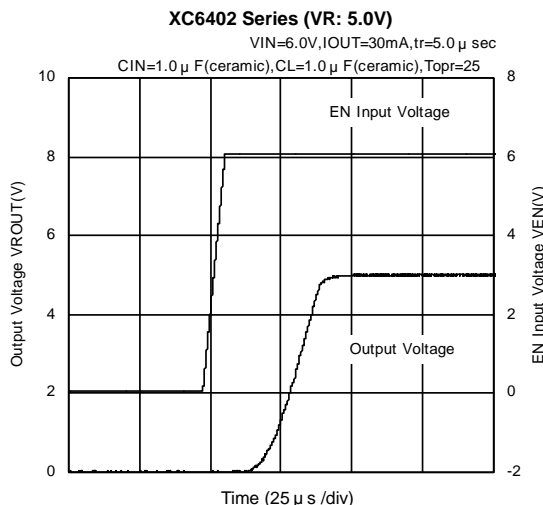
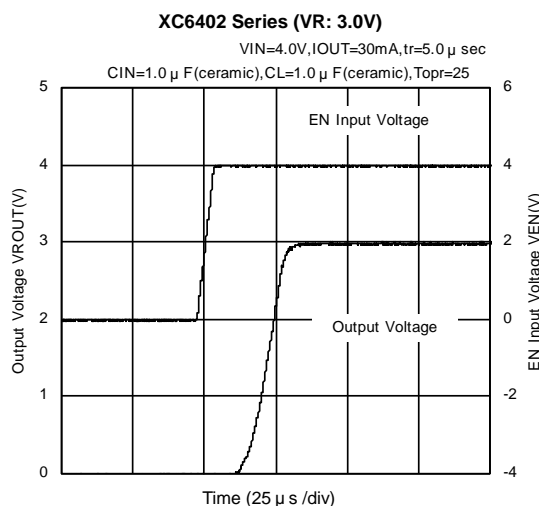
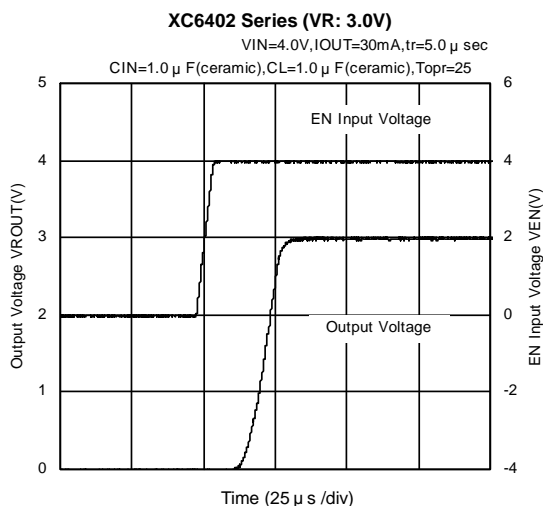
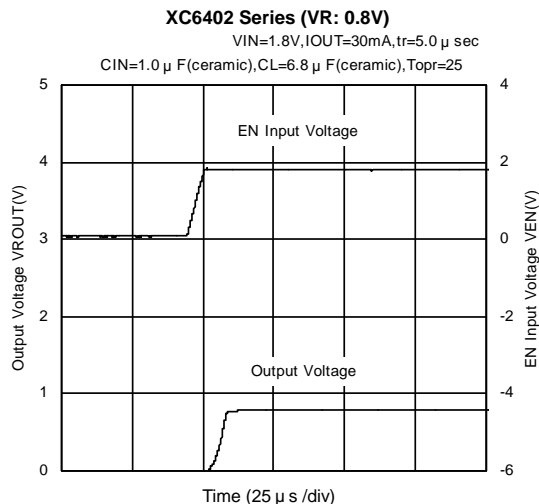
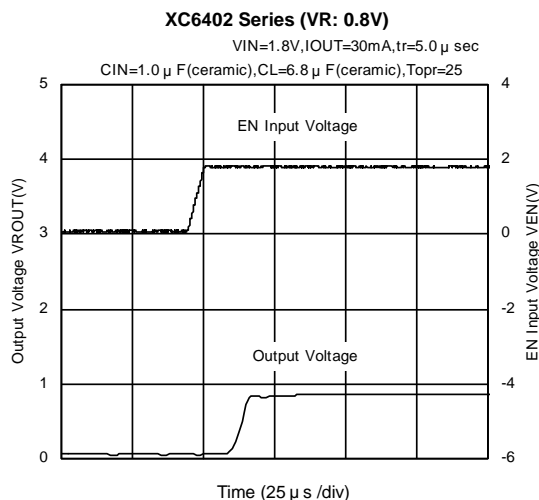

PACKAGING INFORMATION

SOT-25

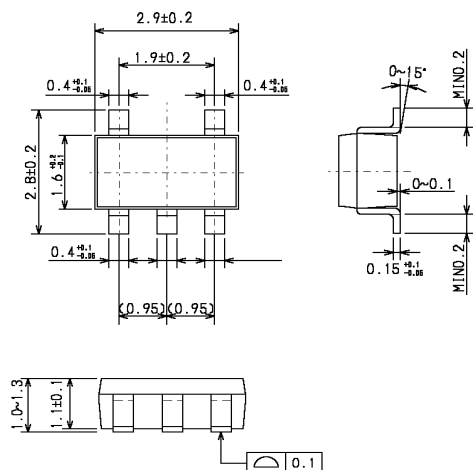

SOT-89-5

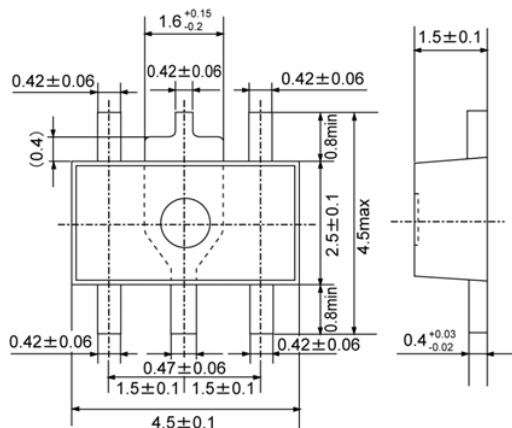

USP-6B

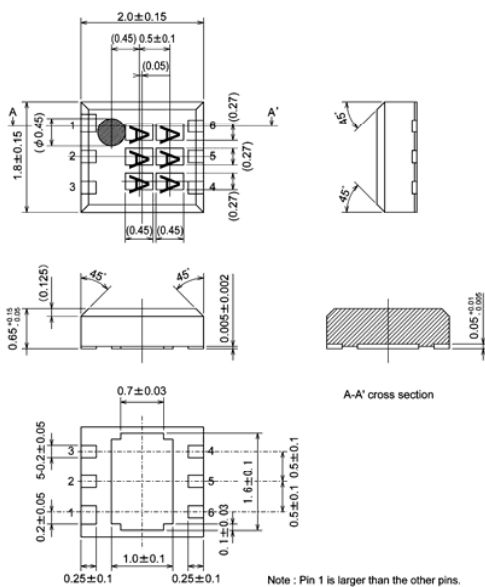

PACKAGING INFORMATION (Continued)

USP-6B Recommended Pattern Layout

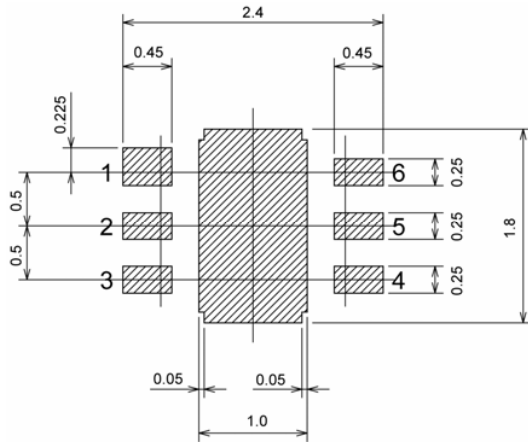

USP-6B Recommended Metal Mask Design

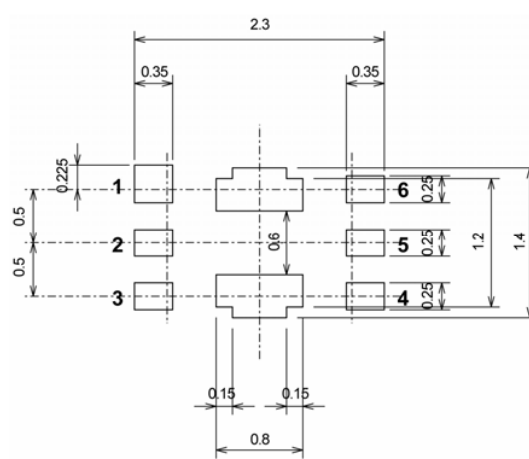

MARKING RULE

SOT-25 / SOT-89-5

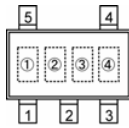

SOT-25
(TOP VIEW)

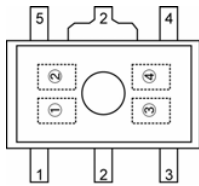

SOT-89-5
(TOP VIEW)

Represents product series

MARK	PRODUCT SERIES
2	XC6402xxxxxx

Represents internal sequential number
Sequential numbering rule

ORDER	NUMBERING RULE
1	01~09
2	10~99
3	A0~A9
4	B0~B9
5	~Z9

*G, I, J, O, Q, W excepted

Represents production lot number

0 to 9, A to Z reverse character 0 to 9, A to Z repeated (G, I, J, O, Q, W excepted)

USP-6B

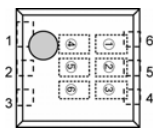

USP-6B
(TOP VIEW)

Represents product series

MARK	PRODUCT SERIES
5	XC6402xxxxDx

Represents optional functions

MARK	PRODUCT SERIES
C	XC6402CxxxDx
F	XC6402FxxxDx

Represents product type

MARK	CE/EN FUNCTION	EN/CE LOGIC	PULL UP/DOWN RESISTANCE	VD OUTPUT LOGIC	PRODUCT SERIES
A	Function	High Active	Pull-down Function	Detect L	XC6402xAxxDx
B	Function	High Active	Pull-down Function	Detect H	XC6402xBxxDx
C	Function	High Active	Pull-down Function	Detect L	XC6402xCxxDx
D	Function	High Active	Pull-down Function	Detect H	XC6402xDxxDx
E	Function	High Active	Nonfunctional	Detect L	XC6402xExxDx
F	Function	High Active	Nonfunctional	Detect H	XC6402xFxxDx
H	Function	High Active	Nonfunctional	Detect L	XC6402xHxxDx
K	Function	High Active	Nonfunctional	Detect H	XC6402xKxxDx
L	Function	Low Active	Pull-up Function	Detect L	XC6402xLxxDx
M	Function	Low Active	Pull-up Function	Detect H	XC6402xMxxDx
N	Function	Low Active	Pull-up Function	Detect L	XC6402xNxxDx
P	Function	Low Active	Pull-up Function	Detect H	XC6402xPxxDx
R	Function	Low Active	Nonfunctional	Detect L	XC6402xRxxDx
S	Function	Low Active	Nonfunctional	Detect H	XC6402xSxxDx
T	Function	Low Active	Nonfunctional	Detect L	XC6402xTxxDx
U	Function	Low Active	Nonfunctional	Detect H	XC6402xUxxDx
V	Nonfunctional	-	-	Detect L	XC6402xVxxDx
X	Nonfunctional	-	-	Detect H	XC6402xXxxDx
Y	Nonfunctional	-	-	Detect L	XC6402xYxxDx
Z	Nonfunctional	-	-	Detect H	XC6402xZxxDx

Represents output voltage and detect voltage
ex.)

MARK	OUTPUT VOLTAGE		PRODUCT SERIES
	V _{ROUT} (V)	V _{DOUT} (V)	
0	6	1.5	XC6402xx06Dx

Represents production lot number

0 to 9, A to Z repeated (G, I, J, O, Q, W excepted)

Note: No character inversion used.

1. The products and product specifications contained herein are subject to change without notice to improve performance characteristics. Consult us, or our representatives before use, to confirm that the information in this catalog is up to date.
2. We assume no responsibility for any infringement of patents, patent rights, or other rights arising from the use of any information and circuitry in this catalog.
3. Please ensure suitable shipping controls (including fail-safe designs and aging protection) are in force for equipment employing products listed in this catalog.
4. The products in this catalog are not developed, designed, or approved for use with such equipment whose failure or malfunction can be reasonably expected to directly endanger the life of, or cause significant injury to, the user.
(e.g. Atomic energy; aerospace; transport; combustion and associated safety equipment thereof.)
5. Please use the products listed in this catalog within the specified ranges.
Should you wish to use the products under conditions exceeding the specifications, please consult us or our representatives.
6. We assume no responsibility for damage or loss due to abnormal use.
7. All rights reserved. No part of this catalog may be copied or reproduced without the prior permission of Torex Semiconductor Ltd.

TOREX SEMICONDUCTOR LTD.