

Surface Mount Automotive Transient Voltage Suppressors

High Temperature Stability and High Reliability Conditions

Patented*



*Patent #'s
4,980,315
5,166,769
5,278,094

DO-214AC (SMA)

| PRIMARY CHARACTERISTICS | |
|-------------------------|---------------|
| V_{BR} | 6.8 V to 43 V |
| P_{PPM} | 400 W |
| P_D | 1.0 W |
| I_{FSM} | 40 A |
| T_J max. | 185 °C |

FEATURES

- Patented PAR[®] construction
- Available in uni-directional polarity only
- 400 W peak pulse power capability with a 10/1000 μ s waveform, repetitive rate (duty cycle): 0.01 %
- Excellent clamping capability
- Very fast response time
- Low incremental surge resistance
- Meets MSL level 1, per J-STD-020C, LF max peak of 260 °C
- Solder dip 260 °C, 40 seconds
- Component in accordance to RoHS 2002/95/EC and WEEE 2002/96/EC



TYPICAL APPLICATIONS

Use in sensitive electronics protection against voltage transients induced by inductive load switching and lighting on ICs, MOSFET, signal lines of sensor units for consumer, computer, industrial, automotive and telecommunication.

MECHANICAL DATA

Case: DO-214AC (SMA)

Epoxy meets UL 94V-0 flammability rating

Terminals: Matte tin plated leads, solderable per J-STD-002B and JESD22-B102D

HE3 suffix for high reliability grade (AEC Q101 qualified)

Polarity: Color band denotes cathode end

| MAXIMUM RATINGS ($T_A = 25$ °C unless otherwise noted) | | | |
|---|----------------|----------------|------|
| PARAMETER | SYMBOL | VALUE | UNIT |
| Peak power dissipation with a 10/1000 μ s waveform ⁽¹⁾⁽²⁾ (Fig. 3) | P_{PPM} | 400 | W |
| Peak power pulse current with a 10/1000 μ s waveform ⁽¹⁾ (Fig. 1) | I_{PPM} | See next table | A |
| Power dissipation at $T_A = 25$ °C ⁽⁴⁾ | P_D | 1.0 | W |
| Peak forward surge current 8.3 ms single half sine-wave ⁽³⁾ | I_{FSM} | 40 | A |
| Maximum instantaneous forward voltage at 25 A ⁽³⁾ | V_F | 3.5 | V |
| Operating junction and storage temperature range | T_J, T_{STG} | - 65 to + 185 | °C |

Notes:

- (1) Non-repetitive current pulse, per Fig. 3 and derated above $T_A = 25$ °C per Fig. 2
- (2) Mounted on P.C.B. with 0.2 x 0.2" (5.0 x 5.0 mm) copper pads attached to each terminal
- (3) Measured on 8.3 ms single half sine-wave or equivalent square wave, duty cycle = 4 pulses per minutes maximum
- (4) Mounted on minimum recommended pad layout



| ELECTRICAL CHARACTERISTICS ($T_A = 25\text{ }^\circ\text{C}$ unless otherwise noted) | | | | | | | | | |
|--|---------------------|---|-------|-------------------------|--------------------------------|---|---|--|---|
| DEVICE | DEVICE MARKING CODE | BREAKDOWN VOLTAGE $V_{BR}^{(1)}$ AT I_T (V) | | TEST CURRENT I_T (mA) | STAND-OFF VOLTAGE V_{WM} (V) | MAXIMUM REVERSE LEAKAGE AT V_{WM} I_R (μA) | $T_J = 150\text{ }^\circ\text{C}$ MAXIMUM REVERSE LEAKAGE AT V_{WM} I_D (μA) | MAXIMUM PEAK PULSE SURGE CURRENT $I_{PPM}^{(2)}$ (A) | MAXIMUM CLAMPING VOLTAGE AT I_{PPM} V_C (V) |
| | | MIN | MAX | | | | | | |
| TPSMA6.8 | ADP | 6.12 | 7.48 | 10 | 5.50 | 300 | 1000 | 37.0 | 10.8 |
| TPSMA6.8A | AEP | 6.45 | 7.14 | 10 | 5.80 | 300 | 1000 | 38.1 | 10.5 |
| TPSMA7.5 | AFP | 6.75 | 8.25 | 10 | 6.05 | 150 | 500 | 34.2 | 11.7 |
| TPSMA7.5A | AGP | 7.13 | 7.88 | 10 | 6.40 | 150 | 500 | 35.4 | 11.3 |
| TPSMA8.2 | AHP | 7.38 | 9.02 | 10 | 6.63 | 50 | 200 | 32.0 | 12.5 |
| TPSMA8.2A | AKP | 7.79 | 8.61 | 10 | 7.02 | 50 | 200 | 33.1 | 12.1 |
| TPSMA9.1 | ALP | 8.19 | 10.00 | 1.0 | 7.37 | 10 | 50 | 29.0 | 13.8 |
| TPSMA9.1A | AMP | 8.65 | 9.55 | 1.0 | 7.78 | 10 | 50 | 29.9 | 13.0 |
| TPSMA10 | ANP | 9.00 | 11.00 | 1.0 | 8.10 | 5.0 | 20 | 26.7 | 15.0 |
| TPSMA10A | APP | 9.50 | 10.50 | 1.0 | 8.65 | 5.0 | 20 | 27.6 | 14.5 |
| TPSMA11 | AQP | 9.90 | 12.10 | 1.0 | 8.92 | 1.0 | 5.0 | 24.7 | 16.2 |
| TPSMA11A | ARP | 10.50 | 11.60 | 1.0 | 9.40 | 1.0 | 5.0 | 25.6 | 15.6 |
| TPSMA12 | ASP | 10.80 | 13.20 | 1.0 | 9.72 | 1.0 | 5.0 | 23.1 | 17.3 |
| TPSMA12A | ATP | 11.40 | 12.60 | 1.0 | 10.20 | 1.0 | 5.0 | 24.0 | 16.7 |
| TPSMA13 | AUP | 11.70 | 14.30 | 1.0 | 10.50 | 1.0 | 5.0 | 21.1 | 19.0 |
| TPSMA13A | AVP | 12.40 | 13.70 | 1.0 | 11.10 | 1.0 | 5.0 | 22.0 | 18.2 |
| TPSMA15 | AWP | 13.50 | 16.30 | 1.0 | 12.10 | 1.0 | 5.0 | 18.2 | 22.0 |
| TPSMA15A | AXP | 14.30 | 15.80 | 1.0 | 12.80 | 1.0 | 5.0 | 18.9 | 21.2 |
| TPSMA16 | AYP | 14.40 | 17.60 | 1.0 | 12.90 | 1.0 | 5.0 | 17.0 | 23.5 |
| TPSMA16A | AZP | 15.20 | 16.80 | 1.0 | 13.60 | 1.0 | 5.0 | 17.8 | 22.0 |
| TPSMA18 | BDP | 16.20 | 19.80 | 1.0 | 14.50 | 1.0 | 5.0 | 15.1 | 26.5 |
| TPSMA18A | BEP | 17.10 | 18.90 | 1.0 | 15.30 | 1.0 | 5.0 | 15.9 | 25.5 |
| TPSMA20 | BFP | 18.00 | 22.00 | 1.0 | 16.20 | 1.0 | 5.0 | 13.7 | 29.1 |
| TPSMA20A | BGP | 19.00 | 21.00 | 1.0 | 17.10 | 1.0 | 5.0 | 14.4 | 27.7 |
| TPSMA22 | BHP | 19.80 | 24.20 | 1.0 | 17.80 | 1.0 | 5.0 | 12.5 | 31.9 |
| TPSMA22A | BKP | 20.90 | 23.10 | 1.0 | 18.80 | 1.0 | 5.0 | 13.1 | 30.6 |
| TPSMA24 | BLP | 21.60 | 26.40 | 1.0 | 19.40 | 1.0 | 5.0 | 11.5 | 34.7 |
| TPSMA24A | BMP | 22.80 | 25.20 | 1.0 | 20.50 | 1.0 | 5.0 | 12.0 | 33.2 |
| TPSMA27 | BNP | 24.30 | 29.70 | 1.0 | 21.80 | 1.0 | 5.0 | 10.2 | 39.1 |
| TPSMA27A | BPP | 25.70 | 28.40 | 1.0 | 23.10 | 1.0 | 5.0 | 10.7 | 37.5 |
| TPSMA30 | BQP | 27.00 | 33.00 | 1.0 | 24.30 | 1.0 | 5.0 | 9.2 | 43.5 |
| TPSMA30A | BRP | 28.50 | 31.50 | 1.0 | 25.60 | 1.0 | 5.0 | 9.7 | 41.4 |
| TPSMA33 | BSP | 29.70 | 36.30 | 1.0 | 26.80 | 1.0 | 5.0 | 8.4 | 47.0 |
| TPSMA33A | BTP | 31.40 | 34.70 | 1.0 | 28.20 | 1.0 | 5.0 | 8.8 | 45.7 |
| TPSMA36 | BUP | 32.40 | 39.60 | 1.0 | 29.10 | 1.0 | 5.0 | 7.7 | 52.0 |
| TPSMA36A | BVP | 34.20 | 37.80 | 1.0 | 30.80 | 1.0 | 5.0 | 8.0 | 49.9 |
| TPSMA39 | BWP | 35.10 | 42.90 | 1.0 | 31.60 | 1.0 | 5.0 | 7.1 | 56.4 |
| TPSMA39A | BXP | 37.10 | 41.00 | 1.0 | 33.30 | 1.0 | 5.0 | 7.4 | 53.9 |
| TPSMA43 | BYP | 38.70 | 47.30 | 1.0 | 34.80 | 1.0 | 5.0 | 6.5 | 61.9 |
| TPSMA43A | BZP | 40.90 | 45.20 | 1.0 | 36.80 | 1.0 | 5.0 | 6.7 | 59.3 |

Note:

- (1) V_{BR} measured after I_T applied for 300 μs , I_T = square wave pulse or equivalent
- (2) Surge current waveform per Fig. 3 and derated per Fig. 2
- (3) All terms and symbols are consistent with ANSI/IEEE C62.35

| ORDERING INFORMATION (Example) | | | | |
|---------------------------------|-----------------|------------------------|---------------|------------------------------------|
| PREFERRED P/N | UNIT WEIGHT (g) | PREFERRED PACKAGE CODE | BASE QUANTITY | DELIVERY MODE |
| TPSMA6.8AHE3/61T ⁽¹⁾ | 0.064 | 61T | 1800 | 7" diameter plastic tape and reel |
| TPSMA6.8AHE3/5AT ⁽¹⁾ | 0.064 | 5AT | 7500 | 13" diameter plastic tape and reel |

Note:

(1) Automotive grade AEC Q101 qualified

RATINGS AND CHARACTERISTICS CURVES

(T_A = 25 °C unless otherwise noted)

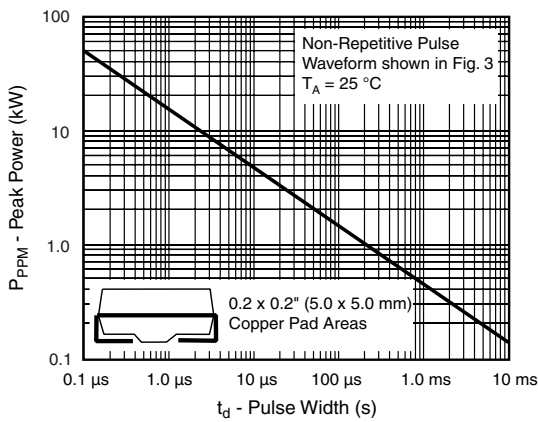

Figure 1. Peak Pulse Power Rating Curve

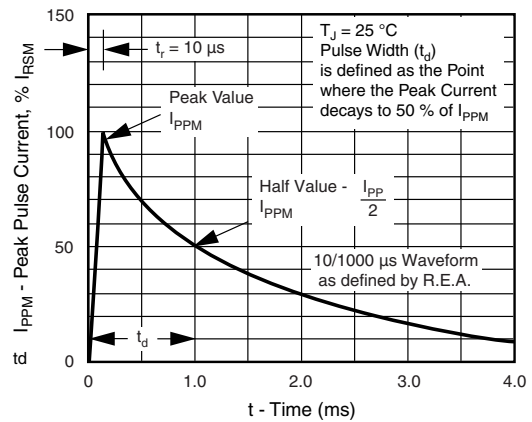

Figure 3. Pulse Waveform

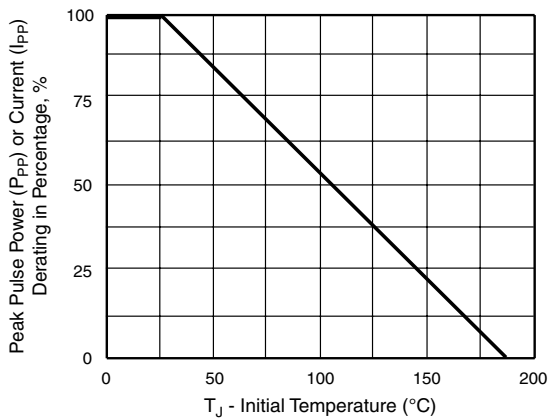

Figure 2. Pulse Power or Current vs. Initial Junction Temperature

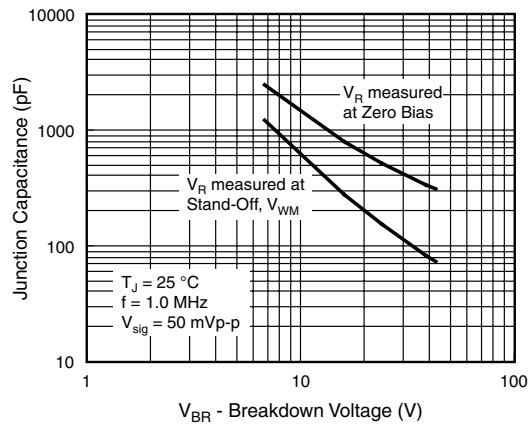

Figure 4. Typical Junction Capacitance

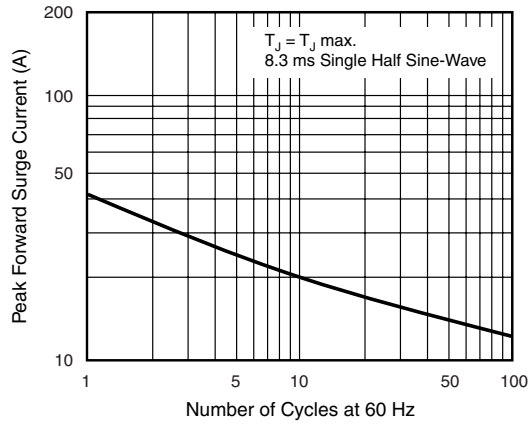
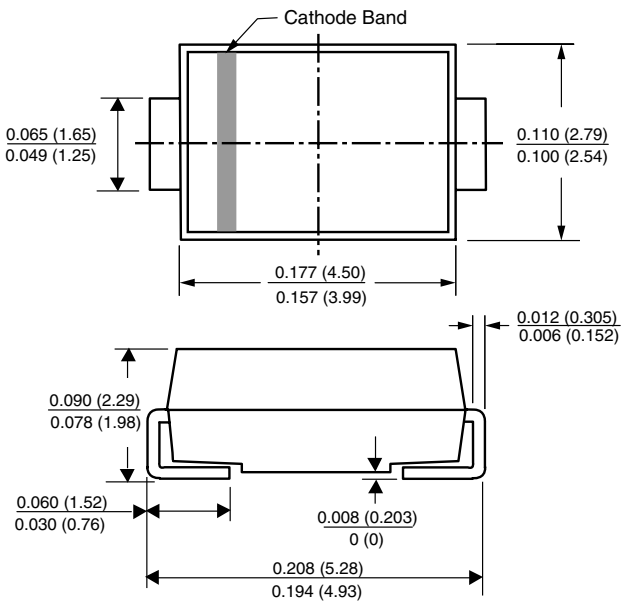

Figure 5. Maximum Non-Repetitive Peak Forward Surge Current

PACKAGE OUTLINE DIMENSIONS in inches (millimeters)

DO-214AC (SMA)



Mounting Pad Layout

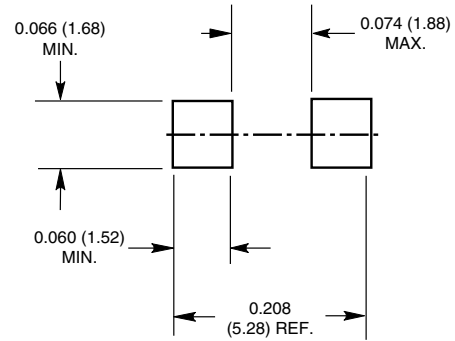



Notice

Specifications of the products displayed herein are subject to change without notice. Vishay Intertechnology, Inc., or anyone on its behalf, assumes no responsibility or liability for any errors or inaccuracies.

Information contained herein is intended to provide a product description only. No license, express or implied, by estoppel or otherwise, to any intellectual property rights is granted by this document. Except as provided in Vishay's terms and conditions of sale for such products, Vishay assumes no liability whatsoever, and disclaims any express or implied warranty, relating to sale and/or use of Vishay products including liability or warranties relating to fitness for a particular purpose, merchantability, or infringement of any patent, copyright, or other intellectual property right.

The products shown herein are not designed for use in medical, life-saving, or life-sustaining applications. Customers using or selling these products for use in such applications do so at their own risk and agree to fully indemnify Vishay for any damages resulting from such improper use or sale.