

Power Management Switch IC Series for PCs and Digital Consumer Product

Small Current Output Power Management Switch ICs

BD2202G, BD2206G



●Description

The High-side switch for memory card slot is an IC High-side switch with a function of over-current protection used in the power supply line of a memory card slot. In the switch part an N channel MOSFET low ON resistance has been 1 circuit integrated.

The switch goes OFF when the over-current condition lasts longer than the over-current shutdown time. The OFF switch is set on latch off mode.

The operating voltage range is 2.7V to 3.6V and the current limit value is set on 400mA, 1A.

Moreover, a soft start function, an under voltage lockout function and an over temperature protection function are integrated.

●Feature

- 1) Single low on-resistance (Typ. = 150mΩ) Nch MOS FET
- 2) Continuous load current 0.2A(BD2202G) / 0.5A(BD2206G)
- 3) Control input logic: Active-High
- 4) Soft start function
- 5) Over current protection circuit
- 6) Over temperature protection circuit
- 7) Under voltage lockout
- 8) Power supply voltage range 2.7V~3.6V
- 9) Operating temperature range -25°C~85°C

●Applications

Memory card slots of STB, Digital still camera, Cell Phones, Notebook PC.

●Line up

Parameter	BD2202G	BD2206G
Continuous load current (A)	0.2	0.5
Short circuit current limit (A)	0.4	1.0
Logic Control input	High	High

May.2008

● Absolute Maximum Ratings

Parameter	Symbol	Limits	Unit
Supply voltage	V _{IN}	-0.3 to 6.0	V
En voltage	V _{EN}	-0.3 to 6.0	V
OUT voltage	V _{OUT}	-0.3 to V _{IN} + 0.3	V
Storage temperature	T _{STG}	-55 to 150	°C
Power dissipation	PD	675 ^{*1}	mW

*1 Mounted on 70mm * 70mm * 1.6mm grass-epoxy PCB. Derating : 5.4mW/°C for operating above Ta=25°C

* Does not do radiation resistance design.

* There is no operation guarantee.

● Operating conditions

◎BD2202G

Parameter	Symbol	Limits	Unit
Operating voltage range	V _{IN}	2.7 to 3.6	V
Operating temperature range	T _{OPR}	-25 to 85	°C
Operating load current	I _{LO}	0 to 200	mA

◎BD2206G

Parameter	Symbol	Limits	Unit
Operating voltage range	V _{IN}	2.7 to 3.6	V
Operating temperature range	T _{OPR}	-25 to 85	°C
Operating load current	I _{LO}	0 to 500	mA

● Electrical characteristics

©BD2202G (Unless otherwise specified, $V_{IN} = 3.3V$, $T_a = 25^{\circ}C$)

DC characteristics

Parameter	Symbol	Limits			Unit	Condition
		Min.	Typ.	Max.		
Operating current	I_{DD}	-	70	90	μA	$V_{EN} = 3.3V$, $V_{OUT} = OPEN$
Standby current	I_{STB}	-	0.01	1	μA	$V_{EN} = 0V$, $OUT = OPEN$
EN input voltage	V_{EN}	2.0	-	-	V	High level input
		-	-	0.8	V	Low level input
EN input current	I_{EN}	-1.0	0.01	1.0	μA	$V_{EN} = 0V$ or $V_{EN} = 3.3V$
ON resistance	R_{ON}	-	150	200	$m\Omega$	$I_{OUT} = 50mA$
Short-circuit output current	I_{SC}	200	-	600	mA	$V_{OUT} = 0V$
Output leak current	I_{LEAK}	-	0.01	10	μA	$V_{EN} = 0V$, $V_{OUT} = 0V$
UVLO threshold	V_{TUVH}	2.1	2.3	2.5	V	V_{IN} increasing
	V_{TUVL}	2.0	2.2	2.4	V	V_{IN} decreasing

AC characteristics

Parameter	Symbol	Limits			Unit	Condition
		Min.	Typ.	Max.		
Output rise time	T_{ON1}	0.25	1.2	6	ms	$R_{OUT} = 500\Omega$, $C_{OUT} = 0.1\mu F$
Output turn on time	T_{ON2}	0.4	2	10	ms	$R_{OUT} = 500\Omega$, $C_{OUT} = 0.1\mu F$
Output fall time	T_{OFF1}	50	100	200	μs	$R_{OUT} = 500\Omega$, $C_{OUT} = 0.1\mu F$
Output turn off time	T_{OFF2}	50	100	200	μs	$R_{OUT} = 500\Omega$, $C_{OUT} = 0.1\mu F$
Over current shutdown time 1	T_{BLANK1}	5	10	15	ms	At continuous over current
Over current shutdown time 2	T_{BLANK2}	3	-	15	ms	At discontinuous over current

DC characteristics

Parameter	Symbol	Limits			Unit	Condition
		Min.	Typ.	Max.		
Operating current	I_{DD}	-	70	90	μA	$V_{EN} = 3.3V$, $V_{OUT} = OPEN$
Standby current	I_{STB}	-	0.01	1	μA	$V_{EN} = 0V$, $OUT = OPEN$
EN input voltage	V_{EN}	2.0	-	-	V	High level input
		-	-	0.8	V	Low level input
EN input current	I_{EN}	-1.0	0.01	1.0	μA	$V_{EN} = 0V$ or $V_{EN} = 3.3V$
ON resistance	R_{ON}	-	150	200	$m\Omega$	$I_{OUT} = 50mA$
Short-circuit output current	I_{SC}	750	-	1350	mA	$V_{OUT} = 0V$
Output leak current	I_{LEAK}	-	0.01	10	μA	$V_{EN} = 0V$, $V_{OUT} = 0V$
UVLO threshold	V_{TUVH}	2.1	2.3	2.5	V	V_{IN} increasing
	V_{TUVL}	2.0	2.2	2.4	V	V_{IN} decreasing

AC characteristics

Parameter	Symbol	Limits			Unit	Condition
		Min.	Typ.	Max.		
Output rise time	T_{ON1}	0.25	1.2	6	ms	$R_{OUT}=500\Omega$, $C_{OUT}=0.1\mu F$
Output turn on time	T_{ON2}	0.4	2	10	ms	$R_{OUT}=500\Omega$, $C_{OUT}=0.1\mu F$
Output fall time	T_{OFF1}	50	100	200	μs	$R_{OUT}=500\Omega$, $C_{OUT}=0.1\mu F$
Output turn off time	T_{OFF2}	50	100	200	μs	$R_{OUT}=500\Omega$, $C_{OUT}=0.1\mu F$
Over current shutdown time 1	T_{BLANK1}	5	10	15	ms	At continuous over current
Over current shutdown time 2	T_{BLANK2}	3	-	15	ms	At discontinuous over current

● Measurement circuits

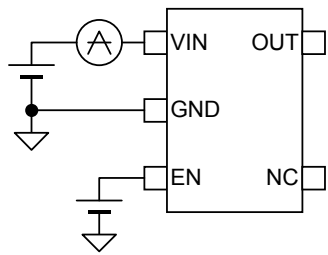

Operating current

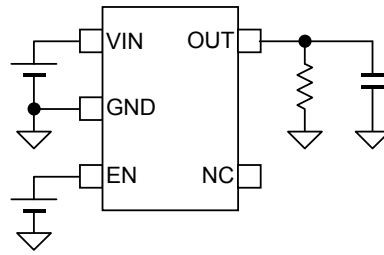

EN input voltage, Output rise / fall time

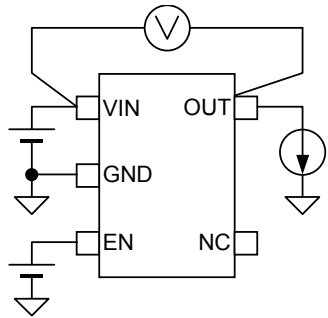

ON resistance

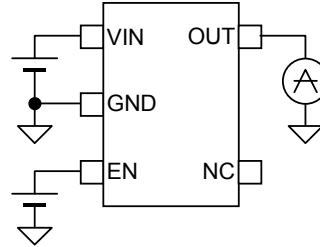

Over current protection characteristics

Fig.1 Measurement circuits

● Timing diagrams

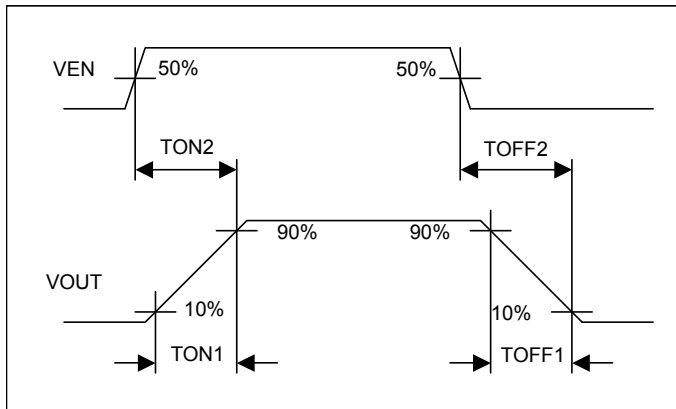

Fig.2 Switch Turn on / off time

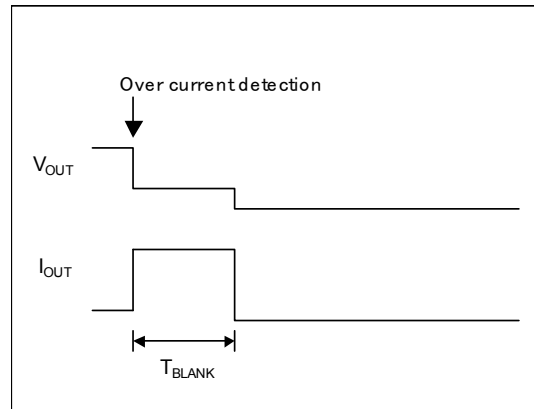

Fig.3 Over current limits characteristics

● Reference data

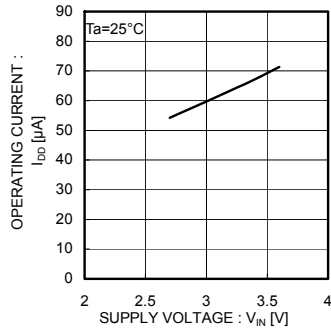

Fig.4 Operating current
EN Enable

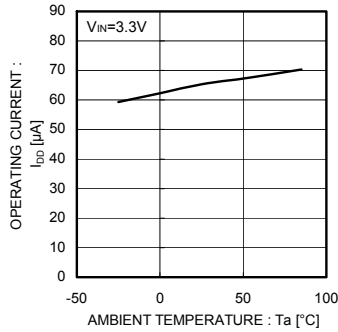

Fig.5 Operating current
EN Enable

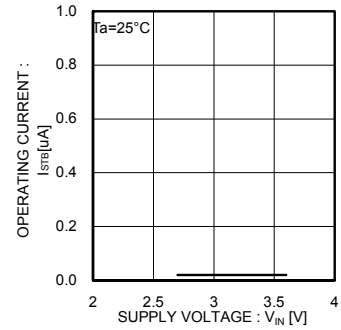

Fig.6 Operating current
EN Disable

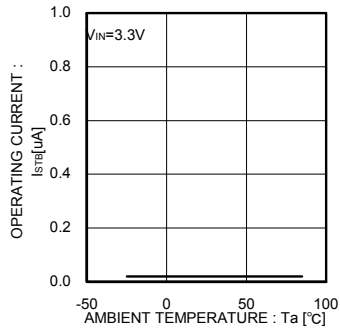

Fig.7 Operating current
EN Disable

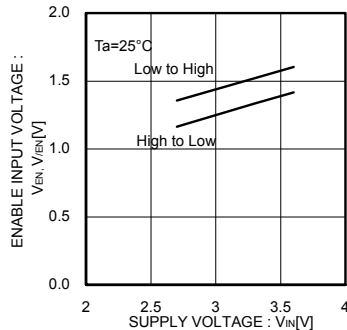

Fig.8 EN input voltage

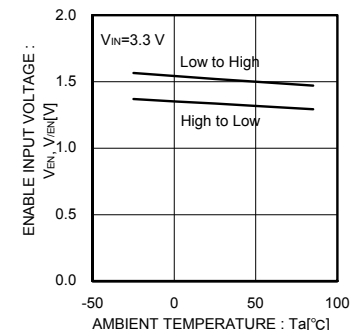

Fig.9 EN input voltage

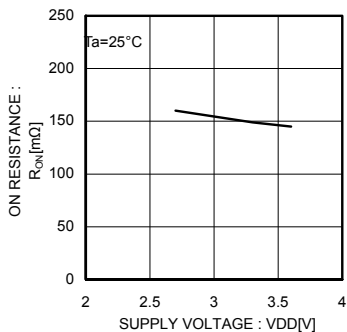

Fig.10 ON resistance

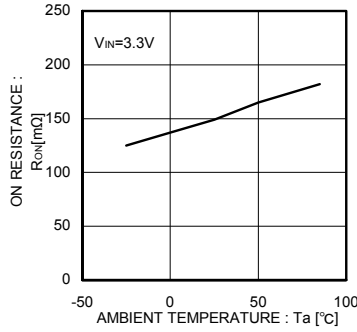

Fig.11 ON resistance

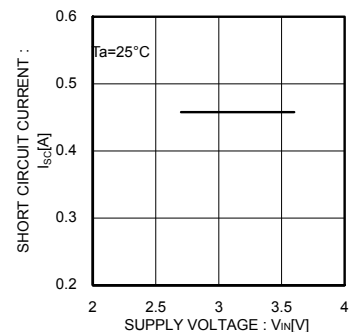

Fig.12 Short circuit output current
(BD2202G)

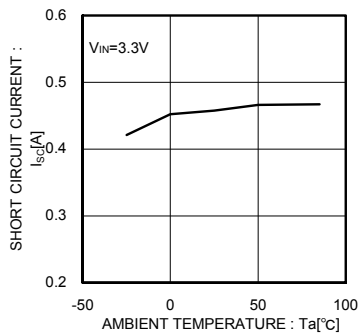

Fig.13 Short circuit output current
(BD2202G)

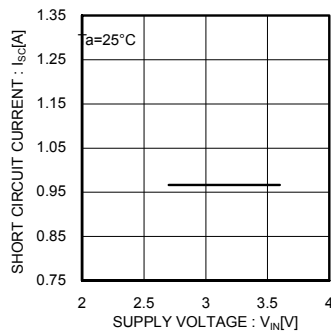

Fig.14 Short circuit output current
(BD2206G)

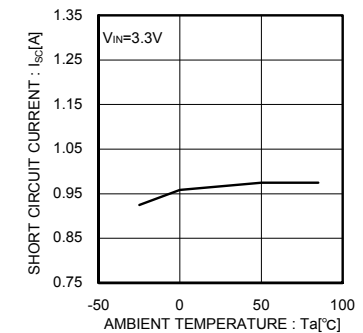

Fig.15 Short circuit output current
(BD2206G)

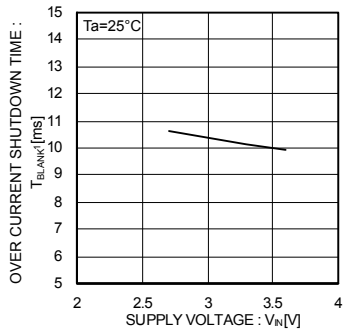

Fig.16 Over current shutdown time

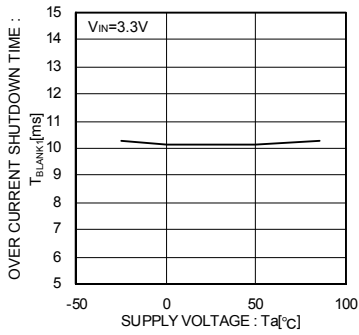

Fig.17 Over current shutdown time

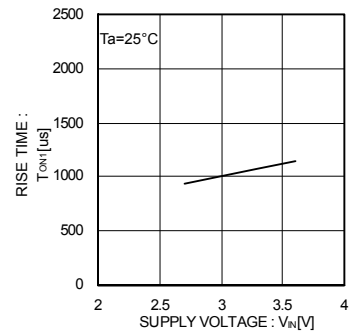

Fig.18 Output rise time

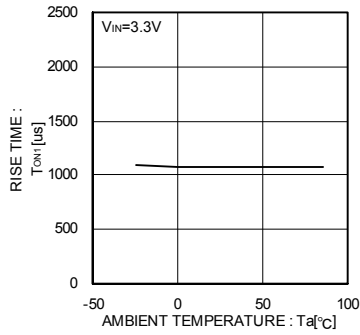

Fig.19 Output rise time

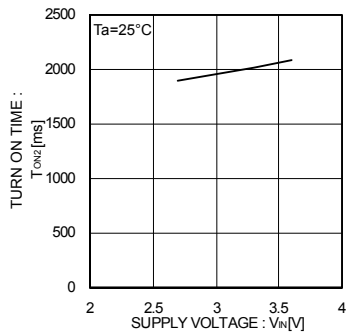

Fig.20 Output turn on time

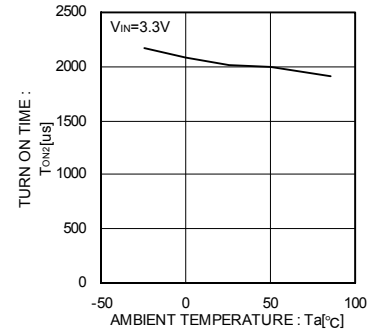

Fig.21 Output turn on time

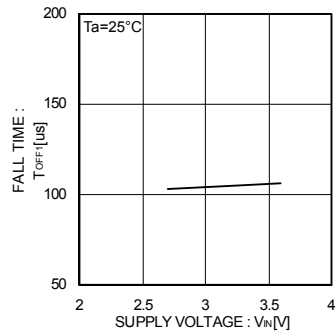

Fig.22 Output fall time

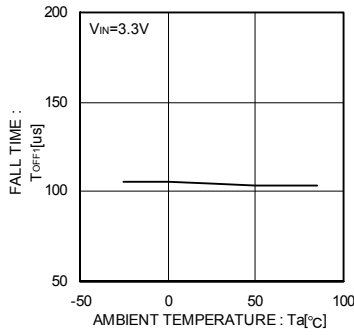

Fig.23 Output fall time

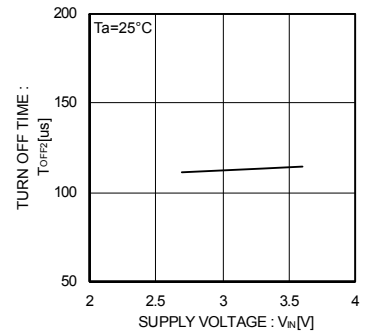

Fig.24 Output turn off time

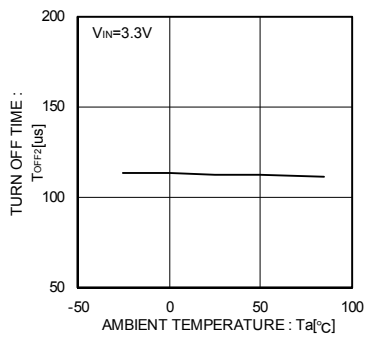

Fig.25 Output turn off time

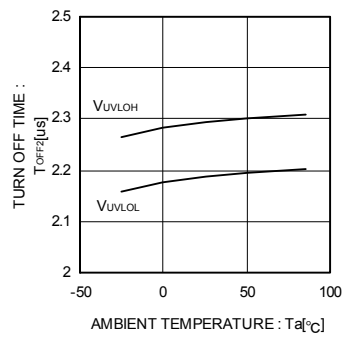

Fig.26 UVLO threshold voltage

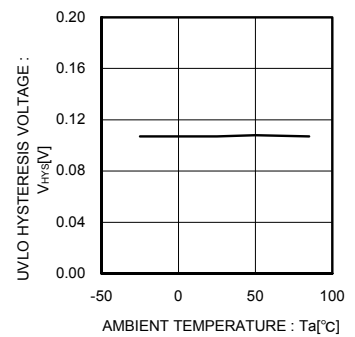

Fig.27 UVLO hysteresis voltage

● Waveform data

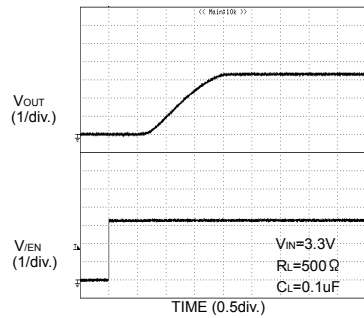

Fig.28 Output turn on response

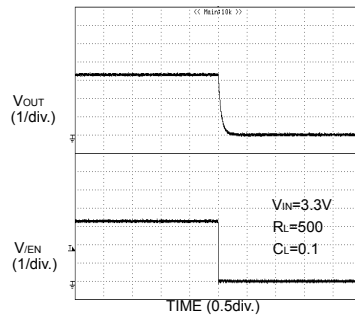

Fig.29 Output turn off response

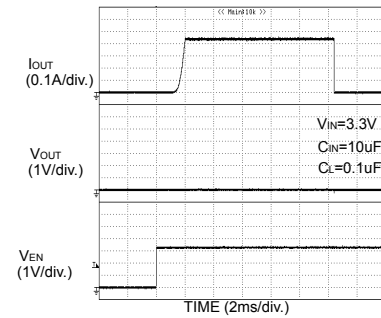

Fig.30 Current limit response Enable into short circuit (BD2202G)

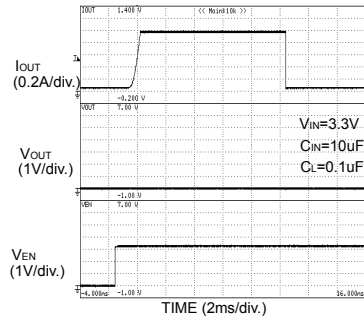

Fig.31 Current limit response Enable into short circuit (BD2206G)

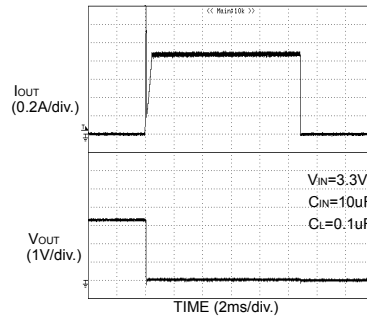

Fig.32 Current limit response Output shorted to GND (BD2202G)

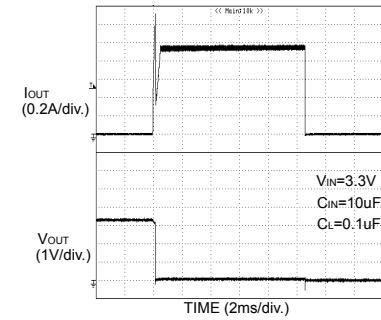

Fig.33 Current limit response Output shorted to GND (BD2206G)

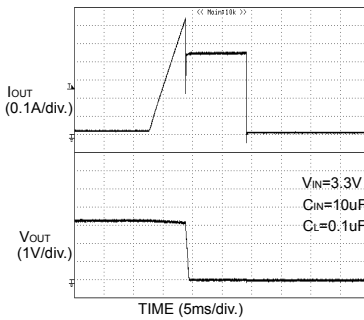

Fig.34 Current limit response Ramped load (1A/10ms) (BD2202G)

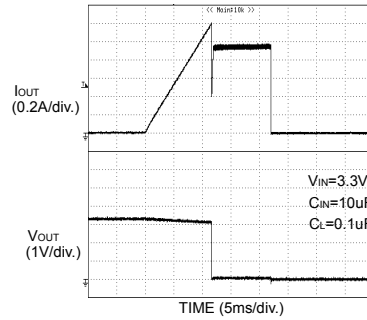

Fig.35 Current limit response Ramped load (1A/10ms) (BD2206G)

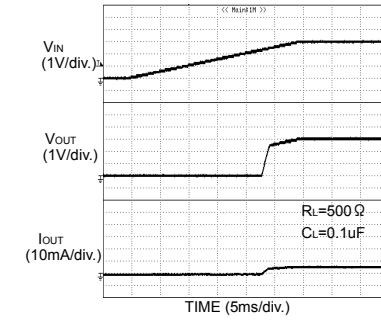

Fig.36 UVLO VIN rising

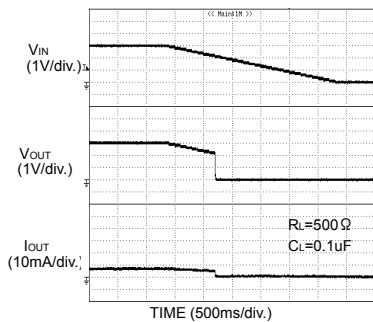

Fig.37 UVLO VIN falling

● Block diagram

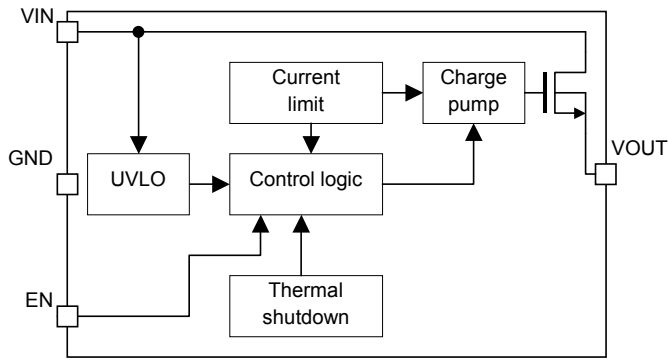

Fig.38 Block diagram

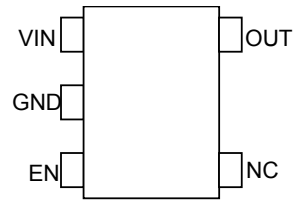

Fig.39 Pin configuration

● Pin description

Pin Number	Pin Name	I / O	Pin function
1	VIN	I	Power supply input terminal. Input terminal to the power switch and power supply input terminal of the internal circuit.
2	GND	I	Ground.
3	EN	I	Power Switch enable input. Active-High Switch on input. A logic high turns the switch on.
4	N.C	-	No connection. Not internally connected.
5	VOUT	O	Power switch output

● I/O circuit

Pin Name	Pin Number	Equivalent circuits
EN	3	
VOUT	5	

● Operation description

BD2202G and BD2206G are high side switch IC with over-current protection function. The operating voltage range is from 2.7V to 3.6V and the current limit value is set on 400mA, 1A.

When an over-current condition lasts longer than an over-current shutdown time, the switch turns OFF. The OFF switch is set on latch mode. The switch set on latch mode returns (to normal) by toggling EN pin from High to Low to High.

1. Switch On/Off control

VIN and VOUT pins are connected to each switch MOSFET drain and source. Moreover, VIN pin is also used as a power supply input for the internal control circuit.

When the switch is turned on from EN control input, VIN and VOUT is connected by a 150mΩ switch. In normal condition, the switch shows bidirectional. Therefore, when the voltage of VOUT is higher than VIN the current flows from VOUT to VIN.

In the switch MOSFET, there is a parasitic diode (body diode) between drain and source. So, even when the switch is off, when voltage of VOUT is higher than VIN, the current flows through the body diode from VOUT to VIN.

2. Over current detection (OCD)

The over current detection circuit limits current when current flowing in switch MOSFET exceeds the current limit threshold. There are three types of response against over current. The over current detection circuit is in operation when the power switch is ON (when EN signal is active).

2-1 When the switch is turned on while the output is in short-circuit status

When the switch is turned on while the output is in short-circuit status, the switch become current limit mode soon.

2-2 When the output short-circuits while the switch is on

When the output short-circuits or heavy load is connected while the switch is on, very large current flows until the over current limit circuit responds. When the current detection, limit circuit works, current limitation is carried out.

2-3 When the output current increases gradually

When the output current increases gradually, current limitation does not work until the output current exceeds the over current detection value. When it exceeds the detection value, current limitation is carried out.

3. Over current shutdown

When the over-current detection circuit detects an over-current, TBLANK timer starts working. When the over-current condition disappears before TBLANK2 stage, TBLANK timer is reset. When the over-current condition progresses to more than TBLANK1, the switch is shut off. The OFF switch is set on latch off mode. The latch is reset when EN terminal is toggled or when UVLO is detected.

4. Under voltage lockout (UVLO)

UVLO keeps the power switch off until VIN voltage exceeds 2.3V (Typ.). Moreover, from a power switch ON situation, if VIN voltage drops to 2.2V (Typ.), the power switch is set on OFF. UVLO has a 100mV hysteresis. The under voltage lock out circuit is in operation when power switch is ON (when EN signal is active).

5. Thermal shutdown

When the chip temperature increases to 160°C (Typ.), the thermal shut down circuit works and the power switch is turned OFF. When the chip temperature falls to 140°C (Typ.), the power switch output returns (to normal). This operation will repeat itself until the causes of the chip temperature rise are removed or until the power switch output is turned off. The thermal shutdown circuit is in operation when the power switch is ON (when EN signal is active).

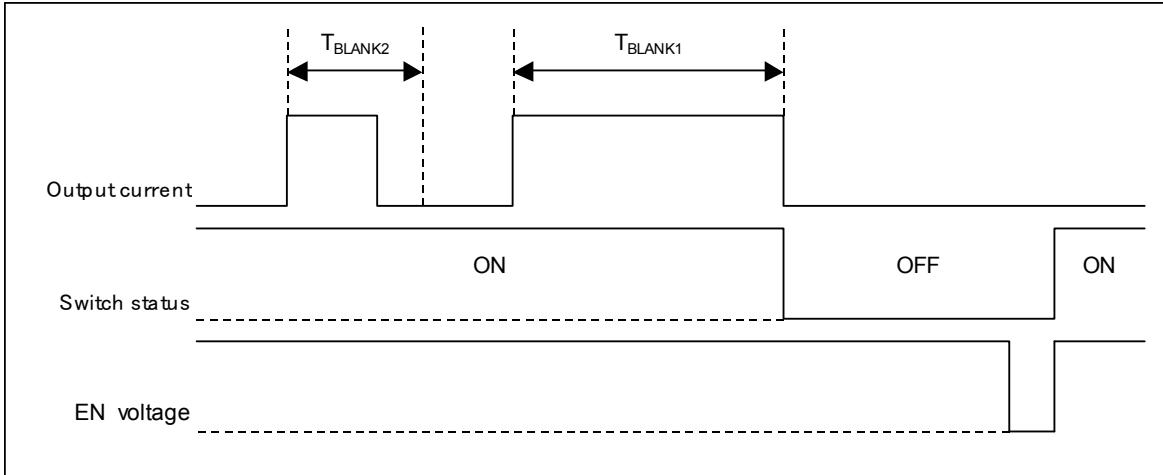

Fig.40 Over-current detection, shutdown operation (return with EN input)

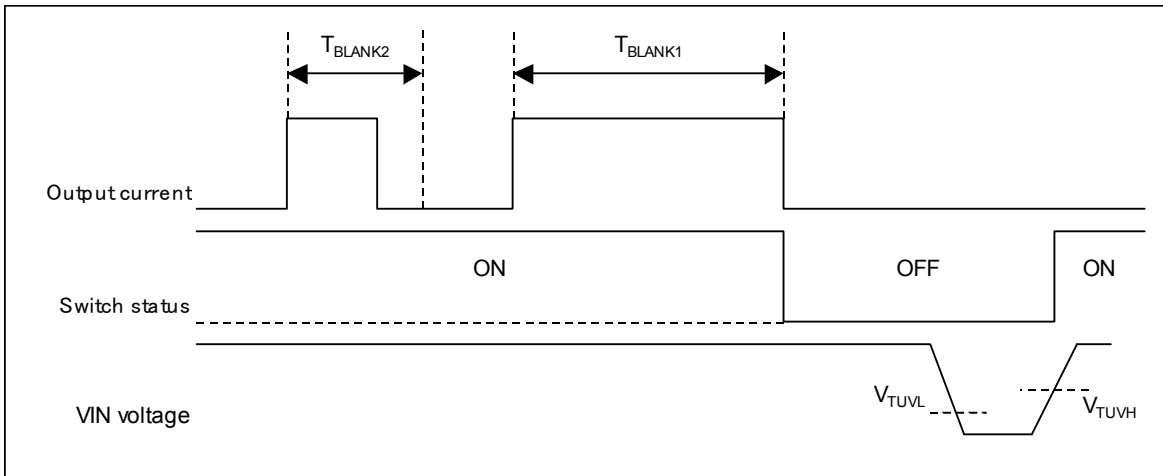

Fig.41 Over-current detection, shutdown operation (return with UVLO operation)

● Typical application circuit

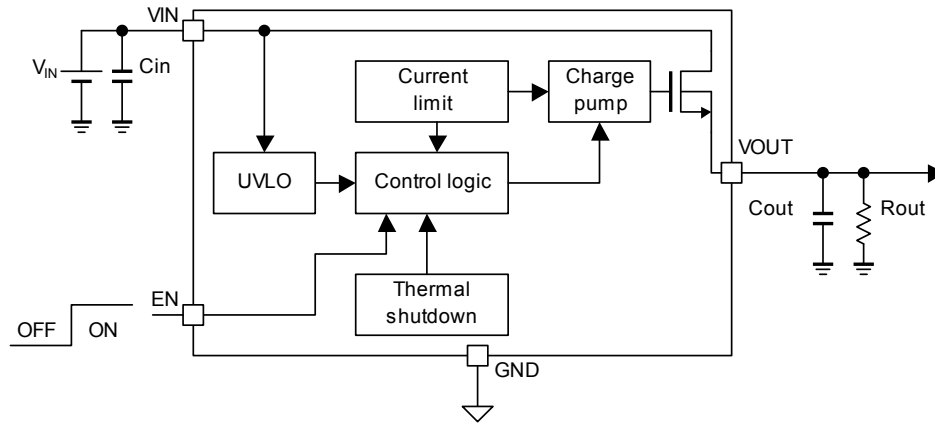

Fig.42 Typical application circuit

● Application information

When an excessive current flows because of an output short circuit, a noise caused by the inductance of power supply to the IC breaks out and it is possible that it influences negatively the IC operation. In order to avoid this problem, please connect C_{IN} bypass capacitor close to the IC VIN and GND pins of the IC. More than $1\mu F$ is recommended.

Due to the internal body diode in the switch, a C_{IN} greater than C_{OUT} is highly recommended.

This system connection diagram does not guarantee operation as an application.

The external circuit constant and so on is changed and it uses, in which there are adequate margins by taking into account external parts or dispersion of IC including not only static characteristics but also transient characteristics.

● Power dissipation characteristics

(SSOP5)

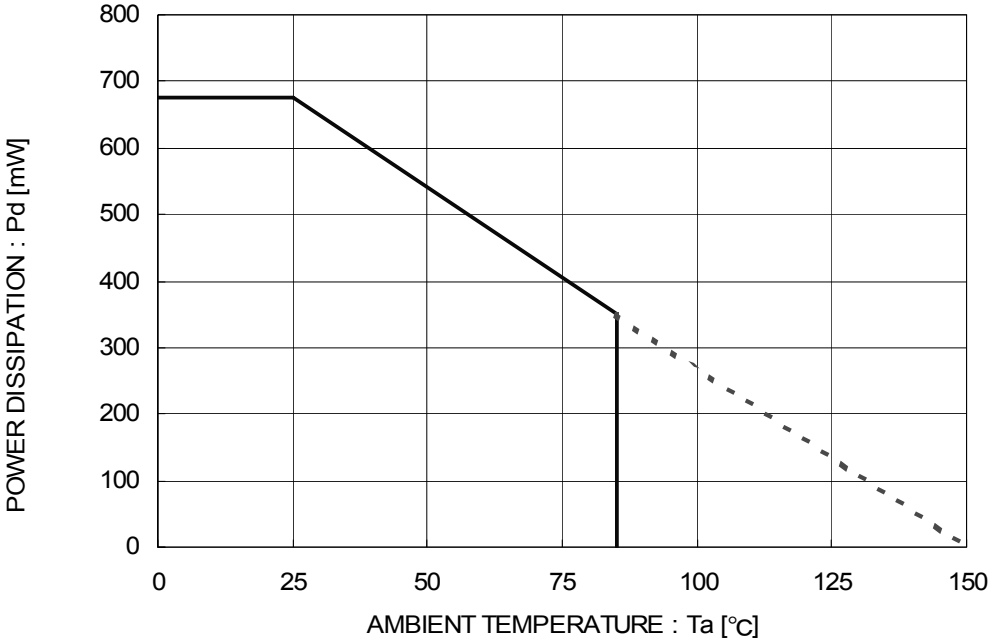

Fig.43 Power dissipation curve (Pd-Ta Curve)

●Cautions on use

(1) Absolute Maximum Ratings

An excess in the absolute maximum ratings, such as supply voltage, temperature range of operating conditions, etc., can break down devices, thus making impossible to identify breaking mode such as a short circuit or an open circuit. If any special mode exceeding the absolute maximum ratings is assumed, consideration should be given to take physical safety measures including the use of fuses, etc.

(2) Operating conditions

These conditions represent a range within which characteristics can be provided approximately as expected. The electrical characteristics are guaranteed under the conditions of each parameter.

(3) Reverse connection of power supply connector

The reverse connection of power supply connector can break down ICs. Take protective measures against the breakdown due to the reverse connection, such as mounting an external diode between the power supply and the IC's power supply terminal.

(4) Power supply line

Design PCB pattern to provide low impedance for the wiring between the power supply and the GND lines. In this regard, for the digital block power supply and the analog block power supply, even though these power supplies has the same level of potential, separate the power supply pattern for the digital block from that for the analog block, thus suppressing the diffraction of digital noises to the analog block power supply resulting from impedance common to the wiring patterns. For the GND line, give consideration to design the patterns in a similar manner.

Furthermore, for all power supply terminals to ICs, mount a capacitor between the power supply and the GND terminal. At the same time, in order to use an electrolytic capacitor, thoroughly check to be sure the characteristics of the capacitor to be used present no problem including the occurrence of capacity dropout at a low temperature, thus determining the constant.

(5) GND voltage

Make setting of the potential of the GND terminal so that it will be maintained at the minimum in any operating state. Furthermore, check to be sure no terminals are at a potential lower than the GND voltage including an actual electric transient.

(6) Short circuit between terminals and erroneous mounting

In order to mount ICs on a set PCB, pay thorough attention to the direction and offset of the ICs. Erroneous mounting can break down the ICs. Furthermore, if a short circuit occurs due to foreign matters entering between terminals or between the terminal and the power supply or the GND terminal, the ICs can break down.

(7) Operation in strong electromagnetic field

Be noted that using ICs in the strong electromagnetic field can malfunction them.

(8) Inspection with set PCB

On the inspection with the set PCB, if a capacitor is connected to a low-impedance IC terminal, the IC can suffer stress. Therefore, be sure to discharge from the set PCB by each process. Furthermore, in order to mount or dismount the set PCB to/from the jig for the inspection process, be sure to turn OFF the power supply and then mount the set PCB to the jig. After the completion of the inspection, be sure to turn OFF the power supply and then dismount it from the jig. In addition, for protection against static electricity, establish a ground for the assembly process and pay thorough attention to the transportation and the storage of the set PCB.

(9) Input terminals

In terms of the construction of IC, parasitic elements are inevitably formed in relation to potential. The operation of the parasitic element can cause interference with circuit operation, thus resulting in a malfunction and then breakdown of the input terminal. Therefore, pay thorough attention not to handle the input terminals, such as to apply to the input terminals a voltage lower than the GND respectively, so that any parasitic element will operate. Furthermore, do not apply a voltage to the input terminals when no power supply voltage is applied to the IC. In addition, even if the power supply voltage is applied, apply to the input terminals a voltage lower than the power supply voltage or within the guaranteed value of electrical characteristics.

(10) Ground wiring pattern

If small-signal GND and large-current GND are provided, it will be recommended to separate the large-current GND pattern from the small-signal GND pattern and establish a single ground at the reference point of the set PCB so that resistance to the wiring pattern and voltage fluctuations due to a large current will cause no fluctuations in voltages of the small-signal GND. Pay attention not to cause fluctuations in the GND wiring pattern of external parts as well.

(11) External capacitor

In order to use a ceramic capacitor as the external capacitor, determine the constant with consideration given to a degradation in the nominal capacitance due to DC bias and changes in the capacitance due to temperature, etc.

(12) Thermal shutdown circuit (TSD)

When junction temperatures become detected temperatures or higher, the thermal shutdown circuit operates and turns a switch OFF. The thermal shutdown circuit, which is aimed at isolating the LSI from thermal runaway as much as possible, is not aimed at the protection or guarantee of the LSI. Therefore, do not continuously use the LSI with this circuit operating or use the LSI assuming its operation.

(13) Thermal design

Perform thermal design in which there are adequate margins by taking into account the power dissipation (Pd) in actual states of use.

● Order model name selection

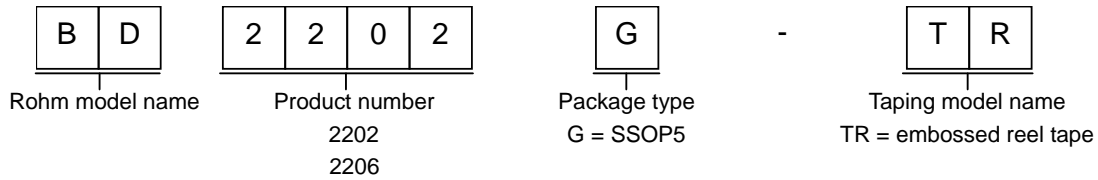

SSOP5

<Dimension>

(Unit:mm)

<Tape and Reel information>

Tape	Embossed carrier tape
Quantity	3000pcs
Direction of feed	TR (The direction is the 1pin of product is at the upper right when you hold reel on the left hand and you pull out the tape on the right hand)

Reel

1Pin

Direction of feed

※When you order, please order in times the amount of package quantity.

- The contents described herein are correct as of May, 2008
- The contents described herein are subject to change without notice. For updates of the latest information, please contact and confirm with ROHM CO.,LTD.
- Any part of this application note must not be duplicated or copied without our permission.
- Application circuit diagrams and circuit constants contained herein are shown as examples of standard use and operation. Please pay careful attention to the peripheral conditions when designing circuits and deciding upon circuit constants in the set.
- Any data, including, but not limited to application circuit diagrams and information, described herein are intended only as illustrations of such devices and not as the specifications for such devices. ROHM CO.,LTD. disclaims any warranty that any use of such devices shall be free from infringement of any third party's intellectual property rights or other proprietary rights, and further, assumes no liability of whatsoever nature in the event of any such infringement, or arising from or connected with or related to the use of such devices.
- Upon the sale of any such devices, other than for buyer's right to use such devices itself, resell or otherwise dispose of the same, implied right or license to practice or commercially exploit any intellectual property rights or other proprietary rights owned or controlled by ROHM CO., LTD. is granted to any such buyer.
- The products described herein utilize silicon as the main material.
- The products described herein are not designed to be X ray proof.

The products listed in this catalog are designed to be used with ordinary electronic equipment or devices (such as audio visual equipment, office-automation equipment, communications devices, electrical appliances and electronic toys). Should you intend to use these products with equipment or devices which require an extremely high level of reliability and the malfunction of which would directly endanger human life (such as medical instruments, transportation equipment, aerospace machinery, nuclear-reactor controllers, fuel controllers and other safety devices), please be sure to consult with our sales representative in advance.

Excellence in Electronics



ROHM CO., LTD.

21, Saini Mizosaki-cho, Ukyo-ku, Kyoto
615-8585, Japan
TEL: +81-75-311-2121 FAX: +81-75-315-0172
URL: <http://www.rohm.com>

Published by
LSI Business Promotion Dept.

Contact us for further information about the products.

San Diego	TEL: +1-858-625-3630	FAX: +1-858-625-3670	Shanghai	TEL: +86-21-6279-2727	FAX: +86-21-6247-2066
Atlanta	TEL: +1-770-754-5972	FAX: +1-770-754-0691	Hangzhou	TEL: +86-571-87658072	FAX: +86-571-87658071
Boston	TEL: +1-978-371-0382	FAX: +1-929-438-7164	Nanjing	TEL: +86-25-8689-0015	FAX: +86-25-8689-0393
Chicago	TEL: +1-547-368-1006	FAX: +1-847-368-1008	Ningbo	TEL: +86-574-87654201	FAX: +86-574-87654208
Dallas	TEL: +1-469-287-5366	FAX: +1-469-382-7973	Qingdao	TEL: +86-532-5779-9312	FAX: +86-532-5779-4553
Denver	TEL: +1-303-708-0908	FAX: +1-303-708-0858	Suzhou	TEL: +86-512-6807-1300	FAX: +86-512-6807-2300
Detroit	TEL: +1-248-348-9920	FAX: +1-248-348-9942	Wuxi	TEL: +86-510-82702693	FAX: +86-510-82702992
Nashville	TEL: +1-615-620-6700	FAX: +1-615-620-6702	Shenzhen	TEL: +86-755-8307-3008	FAX: +86-755-8307-3003
Mexico	TEL: +52-33-3123-2001	FAX: +52-33-3123-2002	Dongguan	TEL: +86-769-8393-3320	FAX: +86-769-8398-4140
Düsseldorf	TEL: +49-2154-9210	FAX: +49-2154-921400	Fuzhou	TEL: +86-591-8801-8698	FAX: +86-591-8801-8690
Munich	TEL: +49-8161-48310	FAX: +49-8161-483120	Guangzhou	TEL: +86-20-8364-9796	FAX: +86-20-8364-9707
Stuttgart	TEL: +49-711-72723710	FAX: +49-711-72723720	Huizhou	TEL: +86-752-205-1054	FAX: +86-752-205-1059
France	TEL: +33-1-5697-3060	FAX: +33-1-5697-3080	Xiamen	TEL: +86-592-238-5705	FAX: +86-592-239-8380
United Kingdom	TEL: +44-1-908-306700	FAX: +44-1-908-235788	Zhuhai	TEL: +86-756-3232-4800	FAX: +86-756-3232-4600
Denmark	TEL: +45-3694-4739	FAX: +45-3694-4789	Hong Kong	TEL: +852-2-740-6262	FAX: +852-2-375-8971
Barcelona	TEL: +34-9375-24320	FAX: +34-9375-24410	Taipei	TEL: +886-2-2500-6956	FAX: +886-2-2503-2869
Hungary	TEL: +36-1-4719338	FAX: +36-1-4719339	Kaohsiung	TEL: +886-7-237-0881	FAX: +886-7-238-7332
Poland	TEL: +48-22-575213	FAX: +48-22-5757001	Singapore	TEL: +65-6332-2322	FAX: +65-6332-5662
Russia	TEL: +7-95-980-6755	FAX: +7-95-937-8290	Philippines	TEL: +63-2-907-6872	FAX: +63-2-809-1422
Seoul	TEL: +82-2-8182-700	FAX: +82-2-8182-715	Thailand	TEL: +66-2-254-4890	FAX: +66-2-256-6334
Masan	TEL: +82-55-240-6234	FAX: +82-55-240-6236	Kuala Lumpur	TEL: +60-3-7958-8355	FAX: +60-3-7958-8377
Dalian	TEL: +86-411-8230-8549	FAX: +86-411-8230-8537	Penang	TEL: +60-4-2286453	FAX: +60-4-2286452
Beijing	TEL: +86-10-8525-2483	FAX: +86-10-8525-2489	Kyoto	TEL: +81-75-365-1218	FAX: +81-75-365-1228
Tianjin	TEL: +86-22-23029181	FAX: +86-22-23029183	Yokohama	TEL: +81-45-476-2290	FAX: +81-45-476-2295

Notes

- No technical content pages of this document may be reproduced in any form or transmitted by any means without prior permission of ROHM CO.,LTD.
- The contents described herein are subject to change without notice. The specifications for the product described in this document are for reference only. Upon actual use, therefore, please request that specifications to be separately delivered.
- Application circuit diagrams and circuit constants contained herein are shown as examples of standard use and operation. Please pay careful attention to the peripheral conditions when designing circuits and deciding upon circuit constants in the set.
- Any data, including, but not limited to application circuit diagrams information, described herein are intended only as illustrations of such devices and not as the specifications for such devices. ROHM CO.,LTD. disclaims any warranty that any use of such devices shall be free from infringement of any third party's intellectual property rights or other proprietary rights, and further, assumes no liability of whatsoever nature in the event of any such infringement, or arising from or connected with or related to the use of such devices.
- Upon the sale of any such devices, other than for buyer's right to use such devices itself, resell or otherwise dispose of the same, no express or implied right or license to practice or commercially exploit any intellectual property rights or other proprietary rights owned or controlled by
- ROHM CO., LTD. is granted to any such buyer.
- Products listed in this document are no antiradiation design.

The products listed in this document are designed to be used with ordinary electronic equipment or devices (such as audio visual equipment, office-automation equipment, communications devices, electrical appliances and electronic toys).

Should you intend to use these products with equipment or devices which require an extremely high level of reliability and the malfunction of which would directly endanger human life (such as medical instruments, transportation equipment, aerospace machinery, nuclear-reactor controllers, fuel controllers and other safety devices), please be sure to consult with our sales representative in advance.

It is our top priority to supply products with the utmost quality and reliability. However, there is always a chance of failure due to unexpected factors. Therefore, please take into account the derating characteristics and allow for sufficient safety features, such as extra margin, anti-flammability, and fail-safe measures when designing in order to prevent possible accidents that may result in bodily harm or fire caused by component failure. ROHM cannot be held responsible for any damages arising from the use of the products under conditions out of the range of the specifications or due to non-compliance with the NOTES specified in this catalog.

Thank you for your accessing to ROHM product informations.

More detail product informations and catalogs are available, please contact your nearest sales office.

ROHM Customer Support System

THE AMERICAS / EUROPE / ASIA / JAPAN

www.rohm.com

Contact us : webmaster@rohm.co.jp