

**DESCRIPTION**

The LX8213 LDO regulator is part of Microsemi's family of positive voltage regulator ICs using CMOS technology. The device provides a compact and cost effective solution featuring low power consumption over a wide supply voltage range, high output voltage accuracy, low dropout, excellent line and load regulation, fast transient response, and low noise.

The LX8213 operates over a wide input voltage range of 2.5V to 6V, and consumes only 60uA typical quiescent current at no load and a low 0.1uA shutdown current. Output voltage options include fixed 1.2V, 3.3V, or an adjustable output voltage which may be set from 1.2V to 5.5V. The LDO delivers up to 300mA of output current, with a foldback current limit of approximately 400mA. At 300mA load, dropout voltage measures only 170mV for a 3.3V output.

Tight load and line regulation is achieved over the full output current and supply range. The high bandwidth control loop provides fast transient response to reduce output voltage deviation using low cost external ceramic capacitors in the 1uF range.

The LX8213 also exhibits low output noise with only 60uV<sub>RMS</sub> over a 100kHz bandwidth. Power supply rejection exceeds 65dB at 100Hz.

Other features of LX8213 include an active low shutdown input with a 3MΩ internal pull-down for low cost power sequencing, internal soft-start circuitry to prevent inrush current, short circuit current limit, and thermal overload protection.

The LX8213 operates over -40°C to +85°C ambient temperature range and is available in a tiny 5 pin SOT-23 ROHS compliant package.

**KEY FEATURES**

- 2.5V to 6V Wide Input Voltage Range
- Fixed Output at 1.2V or 3.3V
- Adjustable Output Voltage Range from 1.2V to 5.5V
- Low Quiescent Current of Typical 60uA
- Low Dropout Voltage of Typical 170mV at 3.3V 300mA
- Stable with Low ESR 1uF Input/Output Bypass Ceramic Capacitors
- Ultra Low Shutdown Current of Typical 0.1uA
- Low Output Noise of Typical 60uV<sub>RMS</sub> at VOUT=1.2V
- Fast Transient Response
- Shutdown Control Input
- Foldback Current Limit
- 50mA Short Circuit Limit
- Over Temperature Protection
- Standard Package SOT-23
- RoHS Compliant

**APPLICATIONS**

- Battery Operated Systems
- Set-Top Box
- LCD TV's
- Routers
- Video Cards
- Hand Held Instruments

**PACKAGE ORDER INFO**
**THERMAL DATA**

<b>T<sub>A</sub> (°C)</b>	<b>SE</b>	<b>Plastic SOT-23 5-pin</b>	<b>θ<sub>JA</sub> = 250 °C/W</b>					
	RoHS Compliant / Pb-free		THERMAL RESISTANCE- JUNCTION TO AMBIENT					
-40 to +85	<p> <b>LX8213-00ISE</b> (Adjustable) Marking "ADYWL"  <b>LX8213-12ISE</b> (1.2V Fixed Output) Marking "AKYWL"  <b>LX8213-33ISE</b> (3.3V Fixed Output) Marking "ALYWL"                      *Marking explanation:                 </p> <div style="display: flex; justify-content: space-around; align-items: center;"> <div style="text-align: center;"> <table border="1" style="border-collapse: collapse;"> <tr><td style="padding: 5px;">A</td></tr> <tr><td style="padding: 5px;">D</td></tr> </table> <p style="font-size: small;">Output Reference. 'AD' – Adjustable Output 'AK' – 1.2V Fixed Output 'AL' – 3.3V Fixed Output</p> </div> <div style="text-align: center;"> <table border="1" style="border-collapse: collapse;"> <tr><td style="padding: 5px;">Y</td></tr> </table> <p style="font-size: small;">Numerical single digit year reference. ( '0', '1', '2',....'9')</p> </div> <div style="text-align: center;"> <table border="1" style="border-collapse: collapse;"> <tr><td style="padding: 5px;">W</td></tr> </table> <p style="font-size: small;">Bi-weekly code. ( 'A' for 1<sup>st</sup>-2<sup>nd</sup> week,....., 'Z' for 51<sup>th</sup>-52<sup>th</sup> week)</p> </div> <div style="text-align: center;"> <table border="1" style="border-collapse: collapse;"> <tr><td style="padding: 5px;">L</td></tr> </table> <p style="font-size: small;">Numerical single digit sub-build lot identity. ( '0', '1', '2',....'9')</p> </div> </div>		A	D	Y	W	L	<p>Junction Temperature Calculation:  <math>T_J = T_A + (P_D \times \theta_{JA})</math>.                      The θ<sub>JA</sub> numbers are guidelines for the thermal performance of the device/pc-board system. All of the above assume no ambient airflow.</p>
A								
D								
Y								
W								
L								
Note: Available in Tape & Reel. Append the letters "TR" to the part number. (i.e. LX8213-xxISE-TR)								

**Absolute Maximum Ratings**

VIN.....	-0.3V to 6.5V
$\overline{\text{SHDN}}$ Input.....	-0.3V to VIN + 0.3V
Output Current.....	450mA
Junction Temperature.....	150°C
Storage Temperature Range.....	-65°C to 150°C
Peak Package Solder Reflow Temp. (40 seconds maximum exposure).....	260°C

Note: Exceeding these ratings could cause damage to the device. All voltages are with respect to ground. Currents are positive into and negative out of the specified terminal.

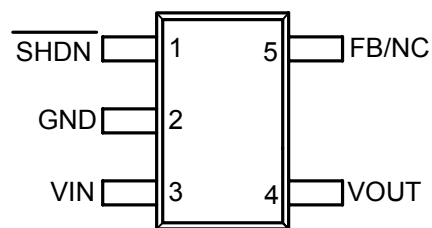
**Package Pin Out**

**SE PACKAGE**  
(Top View)

RoHS / Pb-free 100% Matte Tin Pin Finish

Name	Pin #	Description
$\overline{\text{SHDN}}$	1	Active Low Shutdown Input. Connect to VIN or a logic level high to enable the device. An internal 3MΩ pull-down resistor disables the device when the $\overline{\text{SHDN}}$ pin is floating.
GND	2	Ground. Connect to the local analog ground or to the circuit board ground plane to maximize thermal dissipation. Bypass the input and output capacitors to this plane.
VIN	3	Regulator Input. Operating voltage range is from 2.5V to 6V. Bypass VIN to GND with a 1uF capacitor.
VOUT	4	Regulator Output. Bypass to GND with a 1uF capacitor.
FB (Adjustable Output Version)	5	Feedback Input. For the adjustable output version (LX8213-00), the device output voltage can be set from 1.2V to 5.5V by connecting FB to the center of a resistive voltage divider from VOUT to GND. Note that FB regulates to 0.8V.
N.C. (Fixed Output Version)	5	No Connect. For fixed output versions, pin 5 is a no connect.

**ELECTRICAL CHARACTERISTICS**

LX8213-00ISE (Adjustable Output). Unless otherwise specified, the following specifications apply over the operating temperature of  $-40^{\circ}\text{C} \leq T_A \leq 85^{\circ}\text{C}$  with the following test conditions:  $V_{IN}=(V_{OUT}+1)$ ,  $V_{IN,MIN}=2.5\text{V}$ ,  $\overline{\text{SHDN}} = \text{HIGH}$ ,  $C_{IN}=1\mu\text{F}$ ,  $C_{OUT}=1\mu\text{F}$

Parameter	Symbol	Test Conditions	LX8213-00			Units
			Min	Typ	Max	
<b>▶ LX8213-00ISE (ADJUSTABLE OUTPUT)</b>						
Reference Voltage	$V_{REF}$	$2.5\text{V} \leq V_{IN} \leq 6\text{V}$	0.784	0.8	0.816	V
Input Voltage	$V_{IN}$		2.5		6	V
Maximum Output Current	$I_{OUT(MAX)}$		300	400		mA
Load Regulation	$\frac{\Delta V_{OUT}}{V_{OUT}}$	$1\text{mA} \leq I_{OUT} \leq 300\text{mA}$			0.7	%
Line Regulation	$\frac{\Delta V_{OUT}}{V_{OUT}}$	$(V_{OUT}+0.5\text{V}) \leq V_{IN} \leq 6\text{V}$ , $V_{IN,MIN}=2.5\text{V}$ , $I_{OUT}=30\text{mA}$			0.2	%
Dropout Voltage	$V_{DROP}$	$V_{OUT}=3.3\text{V}$ , $I_{OUT}=300\text{mA}$ , $\Delta V_{OUT}=-1\%$		170	300	mV
Quiescent Current	$I_Q$	$I_{OUT}=0\text{mA}$		60	90	uA
Shutdown Current	$I_{SHDN}$	$\overline{\text{SHDN}} = \text{LOW}$		0.1	1.0	uA
Power Supply Rejection Ratio	PSRR	Ripple 1Vpp, $V_{IN}=3\text{V}$	$f=100\text{Hz}$	68		dB
			$f=1\text{kHz}$	68		
			$f=10\text{kHz}$	54		
Output Voltage Temperature Coefficient	$\frac{(\Delta V_{OUT}/V_{OUT})}{\Delta T}$	$I_{OUT}=30\text{mA}$ , $-40^{\circ}\text{C} \leq T_A \leq 85^{\circ}\text{C}$		$\pm 100$		ppm/ $^{\circ}\text{C}$
Short Current Limit	$I_{SHORT}$	$V_{OUT}=0\text{V}$		50		mA
Soft Start Time	$t_{UP}$			50		uS
RMS Output Noise	$V_{NOISE}$	$T_A=25^{\circ}\text{C}$ , $10\text{Hz} \leq f \leq 100\text{kHz}$ , $V_{OUT}=1.2\text{V}$		60		$\mu\text{V}_{RMS}$
Shutdown "High" Logic Threshold (Device Enabled)			1.5		6	V
Shutdown "Low" Logic Threshold (Device Disabled)			0		0.4	V
VOUT Discharge Internal MOSFET $R_{DS(ON)}$		$\overline{\text{SHDN}} = \text{LOW}$		60		$\Omega$
Shutdown Internal Pull Down Resistance				3		M $\Omega$
Thermal Shutdown				165		$^{\circ}\text{C}$
Thermal Shutdown Hysteresis				30		$^{\circ}\text{C}$

**ELECTRICAL CHARACTERISTICS**

LX8213-12ISE/-33ISE (Fixed Output). Unless otherwise specified, the following specifications apply over the operating temperature of  $-40^{\circ}\text{C} \leq T_A \leq 85^{\circ}\text{C}$  with the following test conditions:  $V_{IN}=2.5\text{V}$  for  $V_{OUT}=1.2\text{V}$ ,  $V_{IN}=(V_{OUT}+1\text{V})$  for  $V_{OUT}=3.3\text{V}$ ,  $\overline{\text{SHDN}} = \text{HIGH}$ ,  $C_{IN}=1\mu\text{F}$ ,  $C_{OUT}=1\mu\text{F}$

Parameter	Symbol	Test Conditions	LX8213-12/33			Units
			Min	Typ	Max	
<b>LX8213-12ISE (1.2V), LX8213-33ISE (3.3V) (FIXED OUTPUT)</b>						
Output Voltage	V <sub>OUT</sub>	$1\text{mA} \leq I_{OUT} \leq 300\text{mA}$	98%* V <sub>OUT</sub>		102%* V <sub>OUT</sub>	V
Input Voltage	V <sub>IN</sub>		2.5		6	V
Maximum Output Current	I <sub>OUT(MAX)</sub>		300	400		mA
Load Regulation	$\Delta V_{OUT} / V_{OUT}$	$1\text{mA} \leq I_{OUT} \leq 300\text{mA}$			0.7	%
Line Regulation	$\Delta V_{OUT} / V_{OUT}$	$2.5\text{V} \leq V_{IN} \leq 6\text{V}$ for $V_{OUT}=1.2\text{V}$ , $(V_{OUT}+0.5\text{V}) \leq V_{IN} \leq 6\text{V}$ for $V_{OUT}=3.3\text{V}$ , $I_{OUT}=30\text{mA}$			0.2	%
Dropout Voltage	V <sub>DROP</sub>	$V_{OUT}=3.3\text{V}$ , $I_{OUT}=300\text{mA}$ , $\Delta V_{OUT}=-1\%$		170	300	mV
Quiescent Current	I <sub>Q</sub>	$I_{OUT}=0\text{mA}$		60	90	uA
Shutdown Current	I <sub>SHDN</sub>	$\overline{\text{SHDN}} = \text{LOW}$		0.1	1.0	uA
Power Supply Rejection Ratio	PSRR	Ripple 1Vpp, $V_{IN}=3\text{V}$ for $V_{OUT}=1.2\text{V}$ $V_{IN}=4.3\text{V}$ for $V_{OUT}=3.3\text{V}$	f=100Hz	68		dB
			f=1kHz	68		
			f=10kHz	54		
Output Voltage Temperature Coefficient	$(\Delta V_{OUT}/V_{OUT}) / \Delta T$	$I_{OUT}=30\text{mA}$ , $-40^{\circ}\text{C} \leq T_A \leq 85^{\circ}\text{C}$		±100		ppm/°C
Short Current Limit	I <sub>SHORT</sub>	$V_{OUT}=0\text{V}$		50		mA
Soft Start Time	t <sub>UP</sub>			50		uS
Shutdown "High" Logic Threshold (Device Enabled)			1.5		6	V
Shutdown "Low" Logic Threshold (Device Disabled)			0		0.4	V
V <sub>OUT</sub> Discharge Internal MOSFET R <sub>DS(ON)</sub>		$\overline{\text{SHDN}} = \text{LOW}$		60		Ω
Shutdown Internal Pull Down Resistance				3		MΩ
Thermal Shutdown				165		°C
Thermal Shutdown Hysteresis				30		°C



### TYPICAL CHARACTERISTICS @ 25°C

#### QUIESCENT CURRENT vs. INPUT VOLTAGE

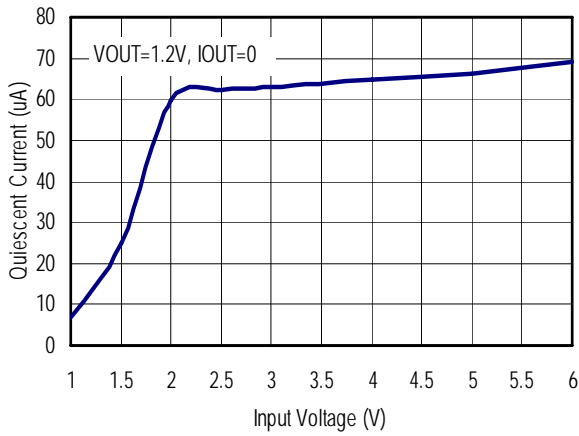

#### QUIESCENT CURRENT vs. OUTPUT CURRENT

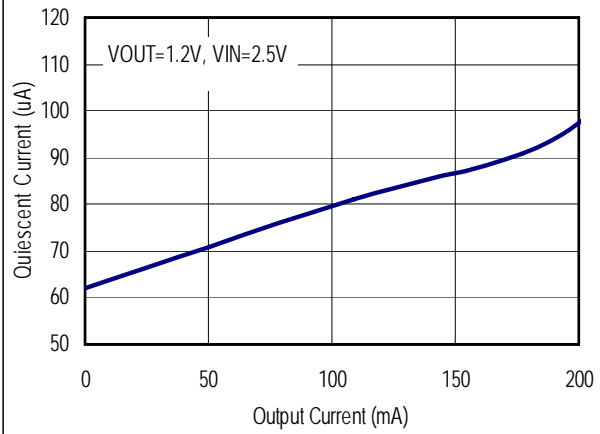

#### LOAD REGULATION

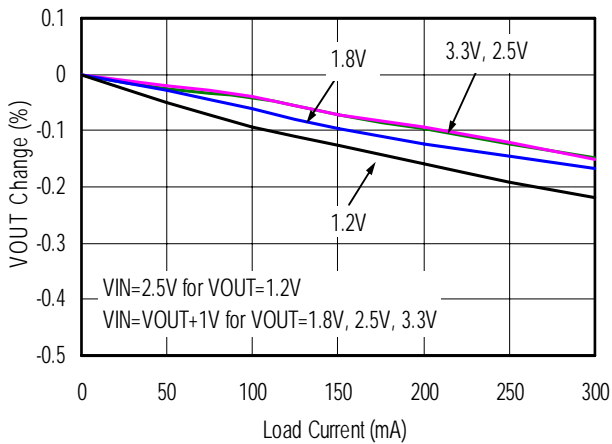

#### LINE REGULATION

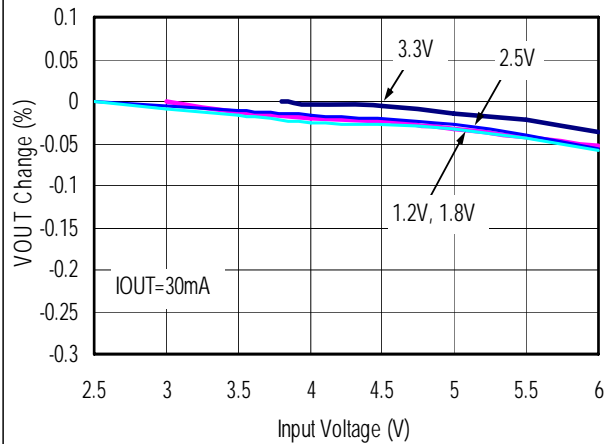

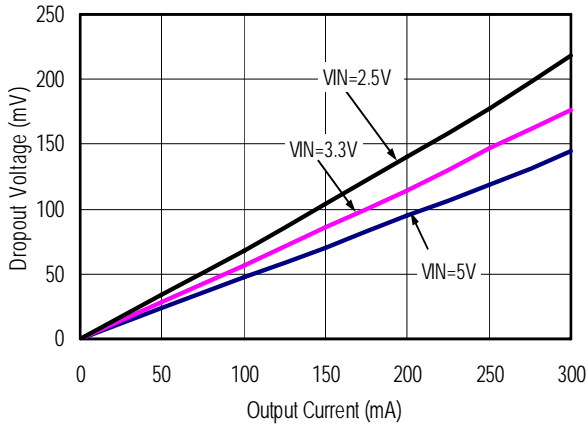
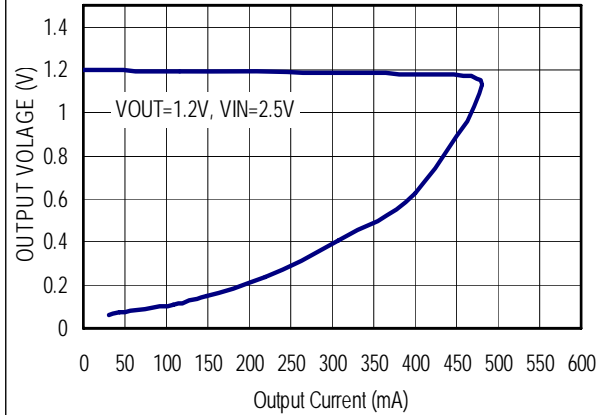
**DROPOUT VOLTAGE vs. OUTPUT CURRENT**

**OUTPUT VOLTAGE vs. OUTPUT CURRENT**

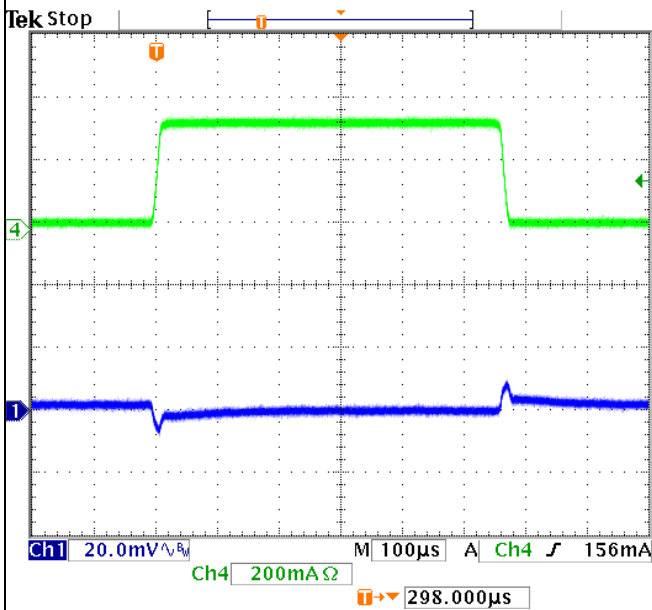
**LOAD TRANSIENT RESPONSE**

(1mA to 300mA)



Channel 1 – 1.2V Output AC Coupled  
 Channel 4 – Output Current 1mA to 300mA,  
 Slew Rate = 0.02A/uS

**LOAD TRANSIENT RESPONSE**

(1mA to 300mA)

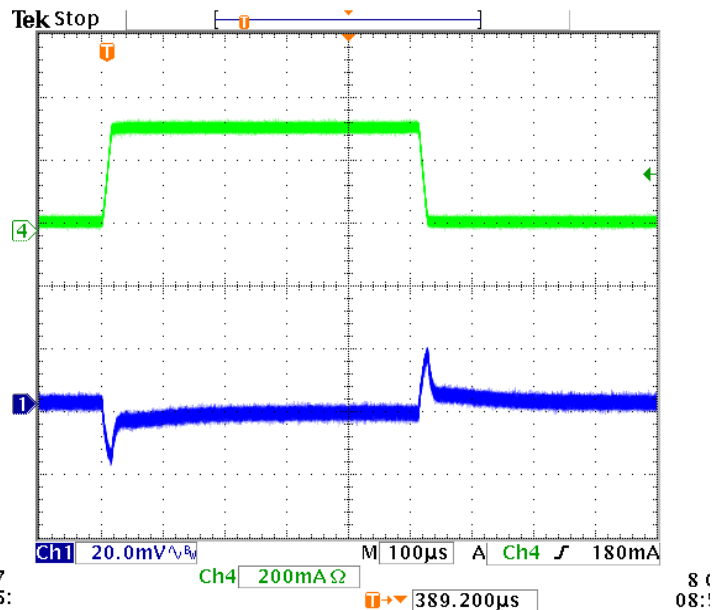

Channel 1 – 3.3V Output AC Coupled  
 Channel 4 – Output Current 1mA to 300mA,  
 Slew Rate = 0.02A/uS

## TYPICAL CHARACTERISTICS @ 25°C

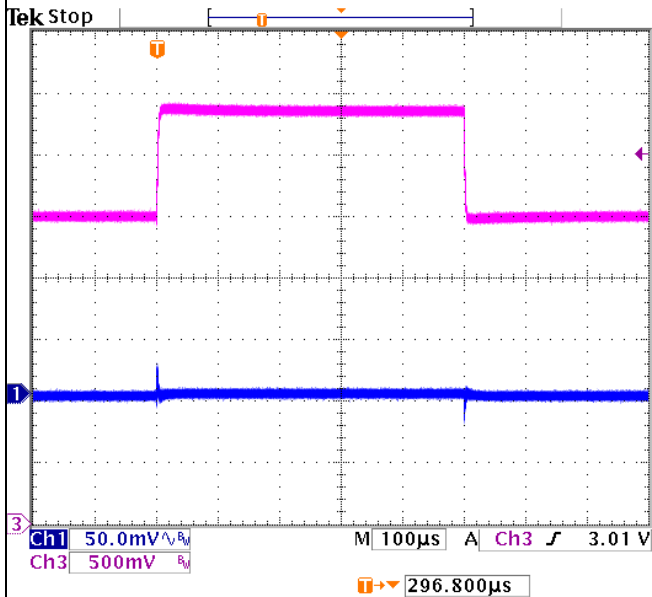
**LINE TRANSIENT RESPONSE**

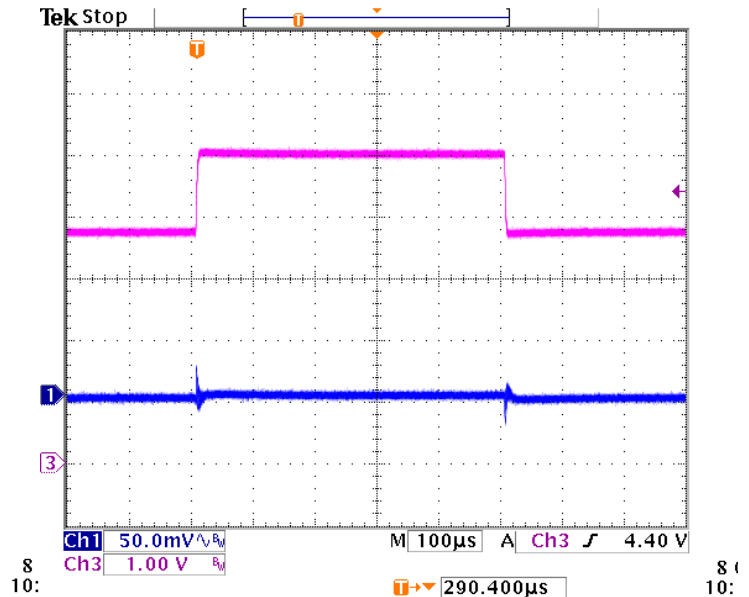
 Channel 1 – 1.2V Output at 30mA, AC Coupled  
 Channel 3 – VIN 2.5V to 3.5V

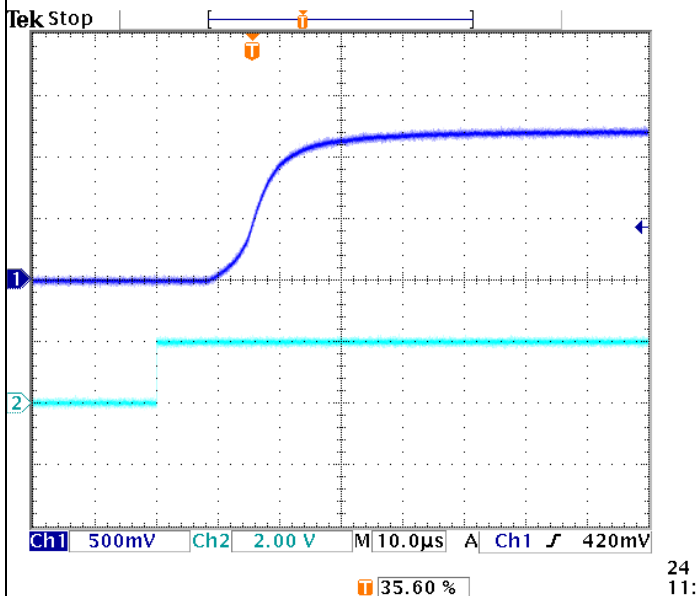
**LINE TRANSIENT RESPONSE**

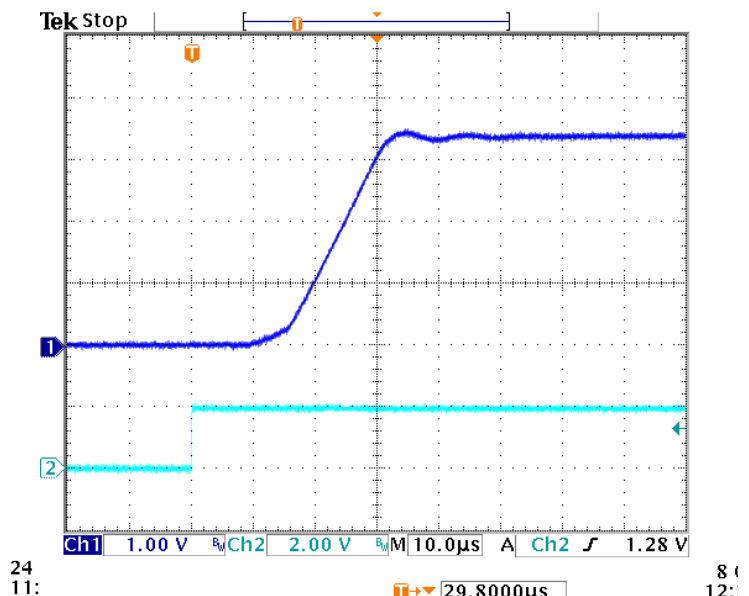
 Channel 1 – 3.3V Output at 30mA, AC Coupled  
 Channel 3 – VIN 3.75V to 5V

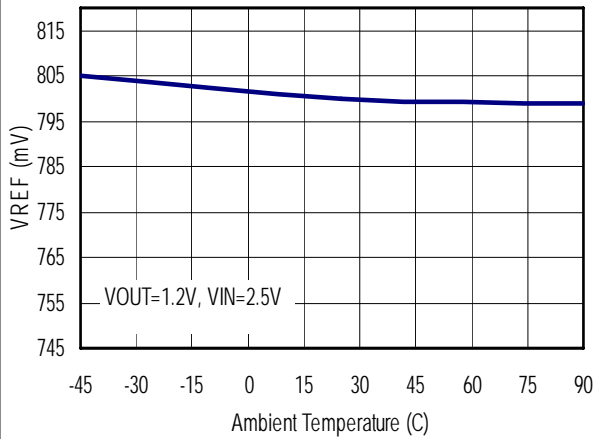
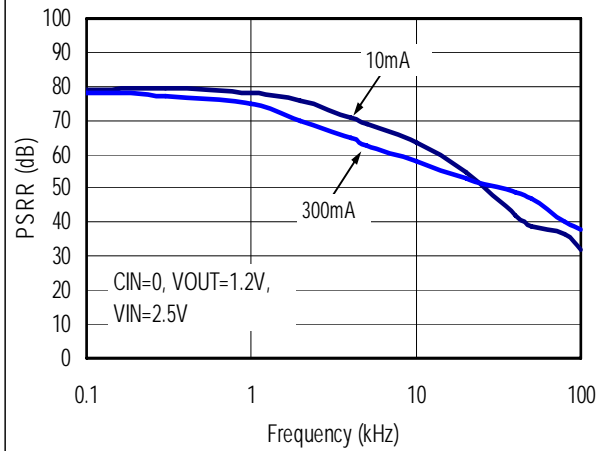
**SOFT START WAVEFORM**

 Channel 1 – 1.2V Output at No Load  
 Channel 2 – SHDN 0V to 2V

**SOFT START WAVEFORM**

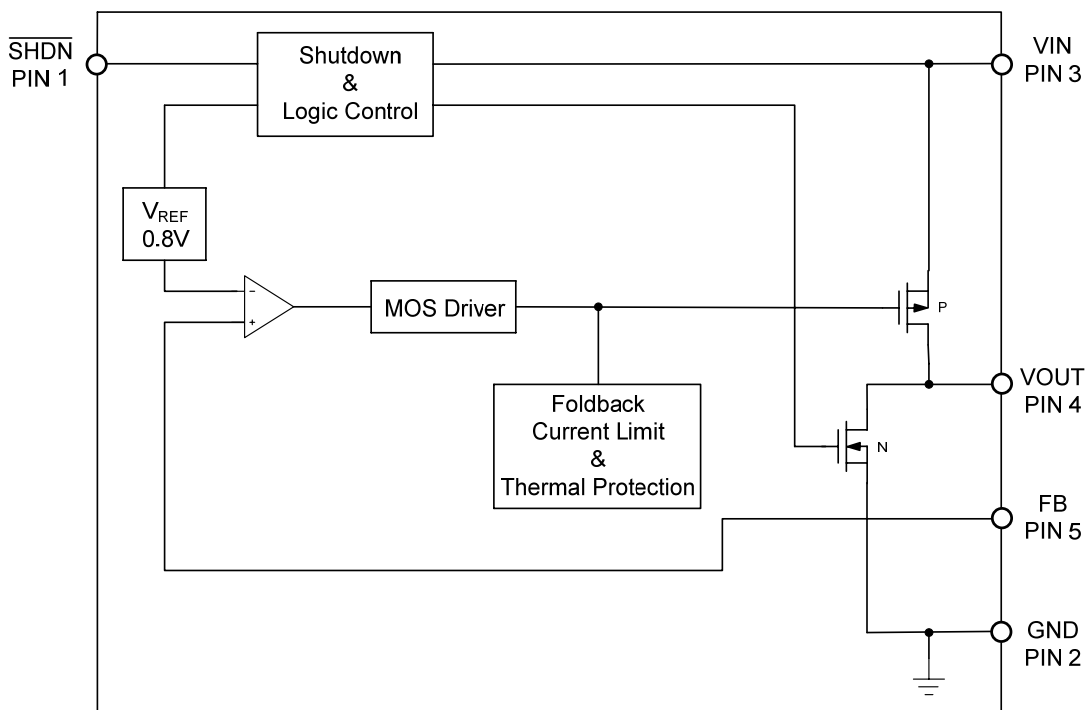
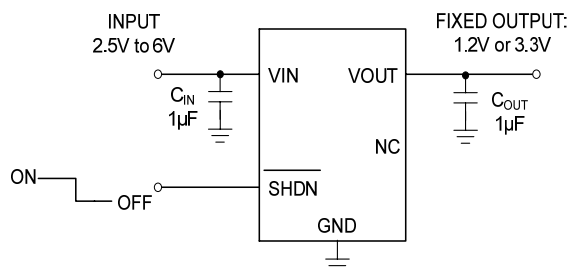
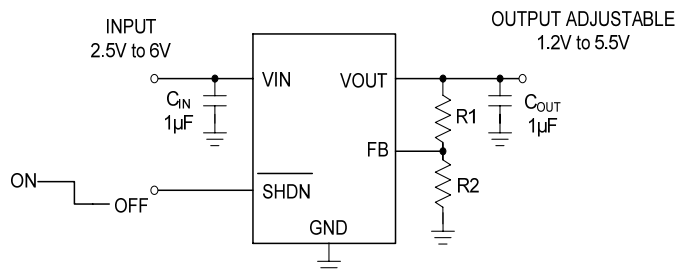
 Channel 1 – 3.3V Output at No Load  
 Channel 2 – SHDN 0V to 2V

**TYPICAL CHARACTERISTICS @ 25°C**
**VREF VOLTAGE vs AMBIENT TEMPERATURE**

**POWER SUPPLY REJECTION RATIO**



**SIMPLIFIED BLOCK DIAGRAM**

**Figure 1 – LX8213-00 (Adjustable Output) Simplified Block Diagram**
**APPLICATION SCHEMATIC**

**Figure 2 – LX8213-12/33 Fixed Output Version Application Schematic**

$$V_{OUT} = 0.8V * [1 + (R1/R2)]$$

**Figure 3 – LX8213-00 Adjustable Output Application Schematic**

**APPLICATION INFORMATION**
**Description**

The LX8213 is a family of CMOS based LDO (Low Drop-Out) regulators in a small 5 pin SOT-23 package that provides a compact and cost effective solution. The LX8213 is offered with fixed output voltages of 1.2V or 3.3V, in addition to an adjustable version with an output voltage range of 1.2V to 5.5V. The LX8213 features low power consumption over a wide supply voltage range, high output voltage accuracy, low dropout, excellent line and load regulation, fast transient response, and low noise. Please refer to the Electrical Characteristics Table for the specifications.

**Input Capacitor**

To improve load transient response and noise rejection, an input bypass capacitor is recommended, but it is not required for stability. There are no requirements for the ESR (Equivalent Series Resistor) on the input capacitor, but tolerance and temperature coefficient must be considered when selecting the capacitor to ensure the capacitor will be around 1 $\mu$ F over the entire operating temperature range. Capacitors with X5R or X7R characteristics are recommended.

**Output Capacitor**

For stability of the regulator, use a minimum 1 $\mu$ F capacitor to bypass from VOUT to GND. Note that the LX8213 is stable using low ESR ceramic capacitors. Capacitors with X5R or X7R characteristics generally perform well and are recommended.

**Adjustable Output Voltage**

The LX8213-00 output voltage can be set within the range of 1.2V to 5.5V by connecting the FB pin to an external resistor divider (See Figure 3). The output voltage can be calculated using:

$$V_{OUT} = 0.8 \left[ 1 + \frac{R1}{R2} \right]$$

R2 is chosen to minimize the power dissipated by the resistor divider network while providing enough FB input bias current. A value of 8.06k $\Omega$  is recommended.

**Shutdown ( $\overline{SHDN}$ )**

The LX8213 includes an active low shutdown input ( $\overline{SHDN}$ ). When the  $\overline{SHDN}$  pin is left floating, an internal pull down resistor to GND of 3M $\Omega$  will automatically disable the device. Upon shutdown, an internal MOSFET connected from VOUT to GND will be turned ON to discharge the output capacitor.

To enable the regulator, set  $\overline{SHDN}$  to logic high. If shutdown capability is not required, connect  $\overline{SHDN}$  pin to VIN. For specification on minimum and maximum logic high levels, please refer to the Electrical Characteristics Table.

**Foldback Current Limit**

The LX8213 uses a foldback current limit. When the load current exceeds approximately 400mA, the output voltage is reduced along with the output current, minimizing power dissipated and protecting the device from excessive heating.

**Short Circuit Current Protection**

Under conditions where the output of the LX8213 is shorted to ground, internal circuitry will limit the device to source only about 50mA.

**Temperature Protection**

The thermal protection shuts down the LX8213 when the junction temperature exceeds approximately 165 $^{\circ}$ C, with a hysteresis of about 30 $^{\circ}$ C.

**Thermal Consideration**

Thermal shutdown protects the integrated circuit from thermal overload caused from a rise in junction temperature during power dissipation. This means the protection is intended for fault protection only and not as a means of current or power limiting during normal application usage. Proper thermal evaluation should be done to ensure that the junction temperature does not exceed its maximum rating. Operating at the maximum  $T_J$  of 150 $^{\circ}$ C can impact reliability. Due to variation in individual device electrical characteristics and thermal resistance, the built in thermal overload protection may be activated at power levels slightly above or below the rated dissipation.

Power dissipation for regulator can be calculated using the following equation:

$$P_D = (V_{IN(MAX)} - V_{OUT(MIN)}) * I_{OUT(MAX)}$$

(Note: power dissipation resulting from quiescent current is negligible)

For the SOT23 package, thermal resistance,  $\theta_{JA}$  is 250 $^{\circ}$ C/W when mounted on a FR4 copper clad PCB. Junction temperature of the integrated circuit can be calculated using:

$$T_J = T_A + T_{RISE}, \text{ substituting: } T_A + (P_D * \theta_{JA}).$$

An example: Given conditions:  $T_A = 25^{\circ}$ C,  $V_{IN} = 2.5V$ ,  $V_{OUT} = 1.2V$ ,  $I_{OUT} = 200mA$ .

Calculated values:

$$\text{Total Power dissipation } P_{D(total)} = (2.5 - 1.2) V * 0.2A = 0.26W$$

$$\text{Junction Temperature } T_J = 25^{\circ}C + (0.26W * 250^{\circ}C/W) = 90^{\circ}C$$

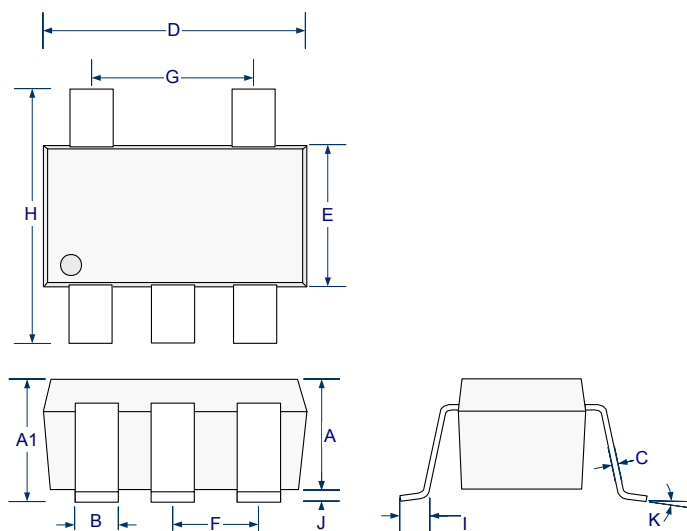
**PACKAGE DIMENSION**
**SE**
**5 Pin Plastic SOT-23**

Dim	MILLIMETERS		INCHES	
	MIN	MAX	MIN	MAX
A	0.90	1.30	0.035	0.051
A1	0.90	1.45	0.035	0.057
B	0.25	0.50	0.010	0.020
C	0.09	0.20	0.004	0.008
D	2.80	3.10	0.110	0.122
E	1.50	1.75	0.059	0.069
F	0.95 BSC		0.038 BSC	
G	1.90 BSC		0.075 BSC	
H	2.60	3.00	0.102	0.118
I	0.35	0.55	0.014	0.022
J	0.00	0.15	0.000	0.006
K	10° MAX		10° MAX	

**Note:**

- Dimensions do not include mold flash or protrusions; these shall not exceed 0.155mm(.006") on any side. Lead dimension shall not include solder coverage.