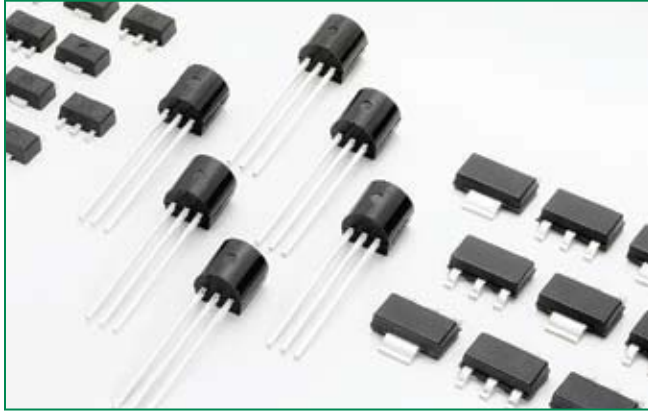

RoHS SxX8xS EV Series 0.8A Sensitive SCR

Main Features

Symbol	Value	Unit
$I_{T(RMS)}$	0.8	A
V_{DRM}/V_{RRM}	400 to 800	V
I_{GT}	5 to 200	μ A

Applications

The SxX8xS series is specifically designed for GFCI (Ground Fault Circuit Interrupter) and gas ignition applications.

Description

New device series offers high static dv/dt and lower turn off (t_q) sensitive SCR with its small die planar construction design. It is specifically designed for GFCI (Ground Fault Circuit Interrupter) and Gas Ignition applications. All SCR's junctions are glass-passivated to ensure long term reliability and parametric stability.

Features

- RoHS compliant
- Thru-hole and surface mount packages
- Surge current capability > 10Amps
- Blocking voltage (V_{DRM}/V_{RRM}) capability - up to 800V
- High dv/dt noise immunity
- Improved turn-off time (t_q) < 25 μ sec
- Sensitive gate for direct microprocessor interface

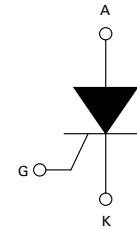
Schematic Symbol

Absolute Maximum Ratings

Symbol	Parameter	Value	Unit
$I_{T(RMS)}$	RMS on-state current (full sine wave)	TO-92 $T_C = 55^\circ\text{C}$	0.8 A
		SOT-89 $T_C = 60^\circ\text{C}$	0.8 A
		SOT-223 $T_L = 60^\circ\text{C}$	0.8 A
$I_{T(AV)}$	Average on-state current	TO-92 $T_C = 55^\circ\text{C}$	0.51 A
		SOT-89 $T_C = 60^\circ\text{C}$	0.51 A
		SOT-223 $T_L = 60^\circ\text{C}$	0.51 A
I_{TSM}	Non repetitive surge peak on-state current (Single cycle, T_J initial = 25°C)	TO-92 $F = 50\text{Hz}$	8 A
		SOT-89 $F = 60\text{Hz}$	10 A
I^2t	I^2t Value for fusing	$t_p = 10\text{ ms}$ $F = 50\text{ Hz}$	0.32 A^2s
		$t_p = 8.3\text{ ms}$ $F = 60\text{ Hz}$	0.41 A^2s
di/dt	Critical rate of rise of on-state current $I_G = 10\text{mA}$	TO-92 $T_J = 125^\circ\text{C}$ SOT-89 SOT-223	50 $\text{A}/\mu\text{s}$
I_{GM}	Peak Gate Current	$t_p = 10\text{ }\mu\text{s}$ $T_J = 125^\circ\text{C}$	1.0 A
$P_{G(AV)}$	Average gate power dissipation	$T_J = 125^\circ\text{C}$	0.1 W
T_{stg}	Storage junction temperature range	—	-40 to 150 $^\circ\text{C}$
T_J	Operating junction temperature range	—	-40 to 125 $^\circ\text{C}$

Electrical Characteristics ($T_J = 25^\circ\text{C}$, unless otherwise specified)

Symbol	Description	Test Conditions	Limit	SxX8xxx			Unit
				S1	S2	S	
I_{GT}	DC Gate Trigger Current	$V_D = 6\text{V}$ $R_L = 100\ \Omega$	MIN.	0.5	1	15	μA
			MAX.	5	50	200	μA
V_{GT}	DC Gate Trigger Voltage	$V_D = 6\text{V}$ $R_L = 100\ \Omega$	MAX.	0.8			V
V_{GRM}	Peak Reverse Gate Voltage	$I_{RG} = 10\ \mu\text{A}$	MIN.	5			V
I_H	Holding Current	$R_{GK} = 1\ \text{k}\Omega$	MAX.	5			mA
(dv/dt)s	Critical Rate-of-Rise of Off-State Voltage	$T_J = 125^\circ\text{C}$ $V_D = V_{DRM} / V_{RRM}$ Exp. Waveform $R_{GK} = 1\ \text{k}\Omega$	MIN.	75			V/ μs
t_q	Turn-Off Time	$T_J = 25^\circ\text{C} @ 600\ \text{V}$ $R_{GK} = 1\ \text{k}\Omega$	MAX.	30	25	25	μs
t_{gt}	Turn-On Time	$I_G = 10\ \text{mA}$ PW = 15 μsec $I_T = 1.6\text{A(pk)}$	MAX.	2.0	2.0	2.0	μs

Static Characteristics ($T_J = 25^\circ\text{C}$, unless otherwise specified)

Symbol	Description	Test Conditions	Limit	Value	Unit
V_{TM}	Peak On-State Voltage	$I_{TM} = 1.6\text{A (pk)}$	MAX.	1.70	V
I_{DRM}	Off-State Current, Peak Repetitive	$T_J = 25^\circ\text{C} @ V_D = V_{DRM}$ $R_{GK} = 1\ \text{k}\Omega$	MAX.	3	μA
		$T_J = 125^\circ\text{C} @ V_D = V_{DRM}$ $R_{GK} = 1\ \text{k}\Omega$	MAX.	500	μA

Thermal Resistances

Symbol	Description	Test Conditions	Value	Unit	
$R_{th(j-c)}$	Junction to case (AC)	$I_T = 0.8\text{A}_{(RMS)}^1$	TO-92	75	$^\circ\text{C}/\text{W}$
			SOT-223	30	$^\circ\text{C}/\text{W}$
			SOT-89	50	$^\circ\text{C}/\text{W}$
$R_{th(j-a)}$	Junction to ambient	$I_T = 0.8\text{A}_{(RMS)}^1$	TO-92	150	$^\circ\text{C}/\text{W}$
			SOT-223	60	$^\circ\text{C}/\text{W}$
			SOT-89	90	$^\circ\text{C}/\text{W}$

¹ 60Hz AC resistive load condition, 100% conduction.

Figure 1: Normalized DC Gate Trigger Current For All Quadrants vs. Junction Temperature

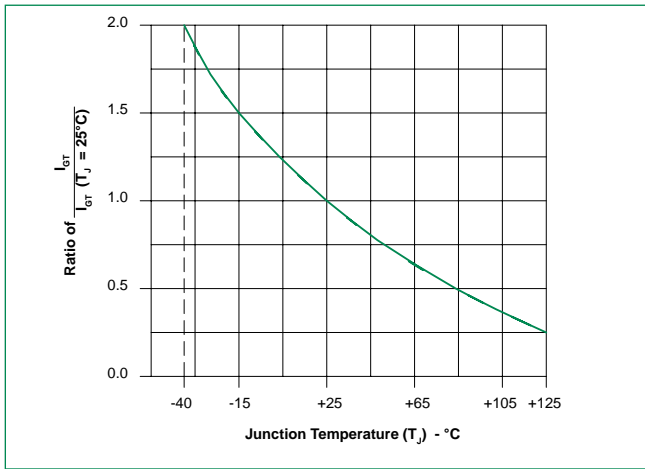

Figure 2: Normalized DC Holding Current vs. Junction Temperature

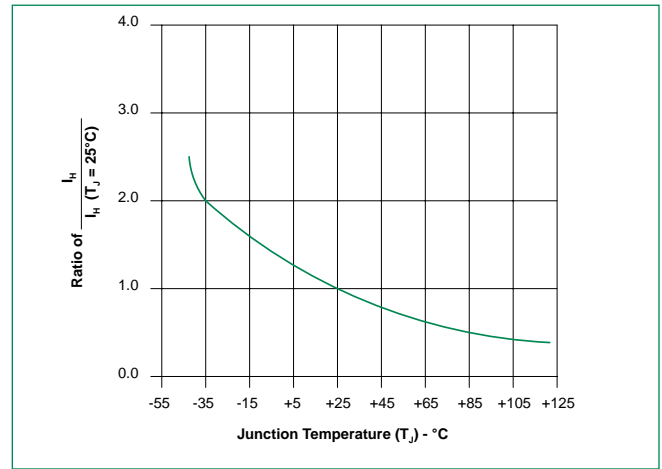

Figure 3: Normalized DC Gate Trigger Voltage vs. Junction Temperature

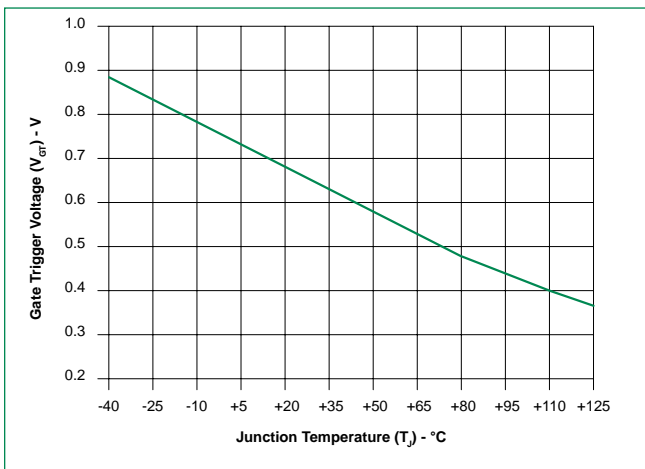

Figure 4: Power Dissipation (Typical) vs. RMS On-State Current

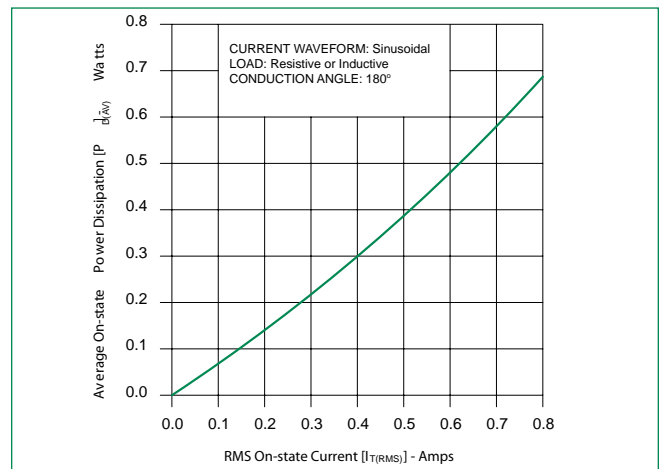

Figure 5: Maximum Allowable Case Temperature vs. On-State Current

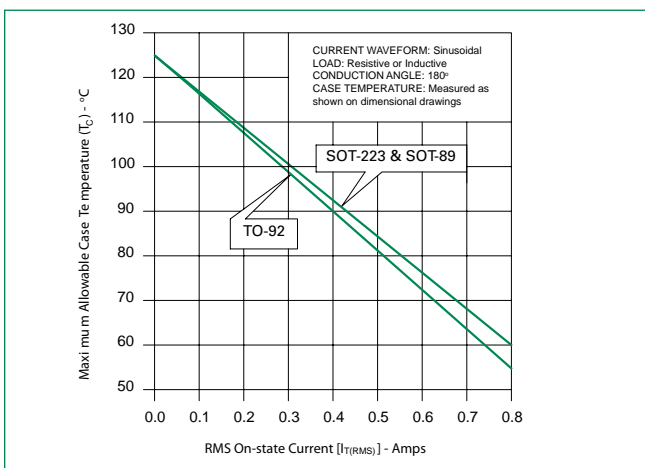
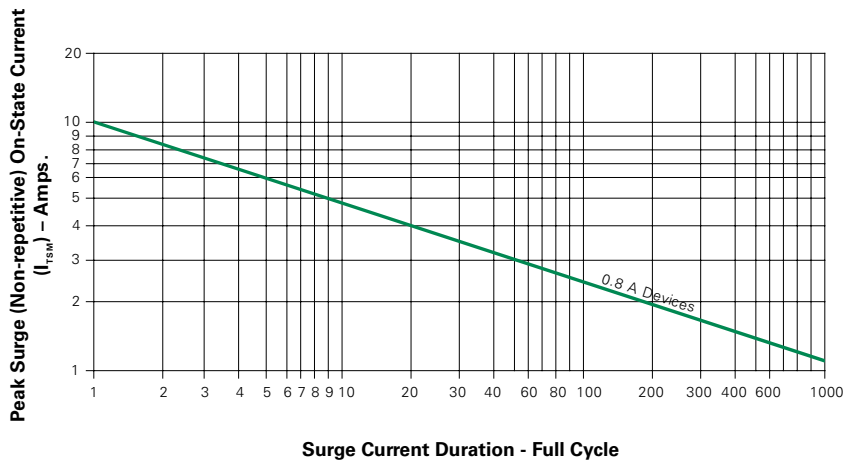

Figure 6: Surge Peak On-State Current vs. Number of Cycles



Supply Frequency: 60Hz Sinusoidal
Load: Resistive
RMS On-State Current (I_{TRMS}): Max Rated Value at Specific Case Temperature

- Notes:
1. Gate control may be lost during and immediately following surge current interval.
 2. Overload may not be repeated until junction temperature has returned to steady-state rated value.

Soldering Parameters

Reflow Condition	Pb – Free assembly	
Pre Heat	- Temperature Min ($T_{s(min)}$)	150°C
	- Temperature Max ($T_{s(max)}$)	200°C
	- Time (min to max) (t_s)	60 – 180 secs
Average ramp up rate (Liquidus Temp (T_L) to peak)	5°C/second max	
$T_{s(max)}$ to T_L - Ramp-up Rate	5°C/second max	
Reflow	- Temperature (T_L) (Liquidus)	217°C
	- Time (min to max) (t_s)	60 – 150 seconds
Peak Temperature (T_p)	260 ^{+0/-5} °C	
Time within 5°C of actual peak Temperature (t_p)	20 – 40 seconds	
Ramp-down Rate	5°C/second max	
Time 25°C to peak Temperature (T_p)	8 minutes Max.	
Do not exceed	280°C	

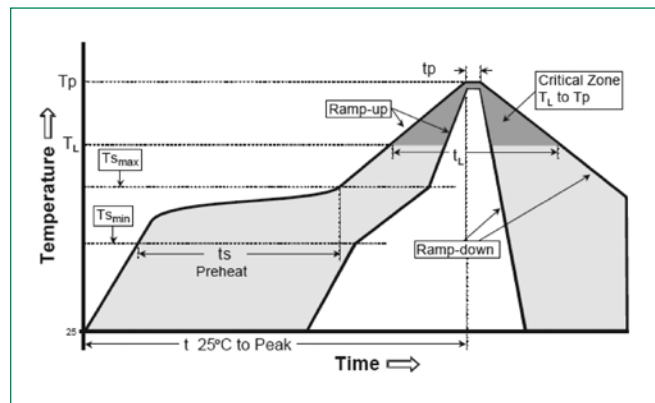

Physical Specifications

Terminal Finish	100% Matte Tin-plated.
Body	UL recognized epoxy meeting flammability classification 94V-0.
Lead Material	Copper Alloy

Design Considerations

Careful selection of the correct device for the application's operating parameters and environment will go a long way toward extending the operating life of the thyristor. Good design practice should limit the maximum continuous current through the main terminals to 75% of the device rating. Other ways to ensure long life for a power discrete semiconductor are proper heat sinking and selection of voltage ratings for worst case conditions. Overheating, overvoltage (including dv/dt), and surge currents are the main killers of semiconductors. Correct mounting, soldering, and forming of the leads also help protect against component damage.

Reliability/Environmental Tests

Test	Specifications and Conditions
AC Blocking	MIL-STD-750, M-1040, Cond A Applied Peak AC voltage @ 110°C for 1008 hours
Temperature Cycling	MIL-STD-750, M-1051, 100 cycles; -40°C to +150°C; 15-min dwell-time
Temperature/Humidity	EIA / JEDEC, JESD22-A101 1008 hours; 320V - DC: 85°C; 85% rel humidity
High Temp Storage	MIL-STD-750, M-1031, 1008 hours; 150°C
Low-Temp Storage	1008 hours; -40°C
Thermal Shock	MIL-STD-750, M-1056 10 cycles; 0°C to 100°C; 5-min dwell-time at each temperature; 10 sec (max) transfer time between temperature
Autoclave	EIA / JEDEC, JESD22-A102 168 hours (121°C at 2 ATMs) and 100% R/H
Resistance to Solder Heat	MIL-STD-750 Method 2031
Solderability	ANSI/J-STD-002, category 3, Test A
Lead Bend	MIL-STD-750, M-2036 Cond E

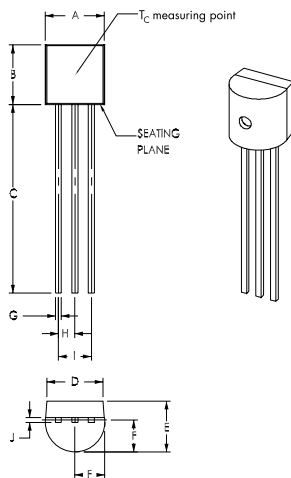
Dimensions – TO-92

Dimensions	Inches			Millimeters		
	Min	Typ	Max	Min	Typ	Max
A	0.175	—	0.205	4.450	—	5.200
B	0.170	—	0.210	4.320	—	5.330
C	0.500	—	—	12.700	—	—
D	0.135	0.165	—	3.430	4.190	—
E	0.125	—	0.165	3.180	—	4.190
F	0.080	0.095	0.105	2.040	2.400	2.660
G	0.016	—	0.021	0.407	—	0.533
H	0.045	0.050	0.055	1.150	1.270	1.390
I	0.095	0.100	0.105	2.420	2.540	2.660
J	0.015	—	0.020	0.380	—	0.500

Dimensions – SOT-223

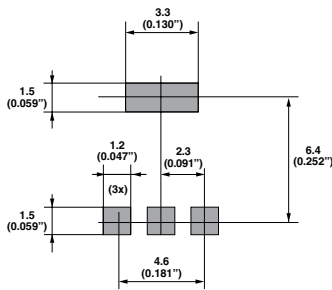
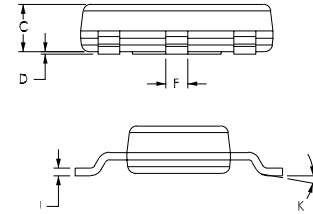
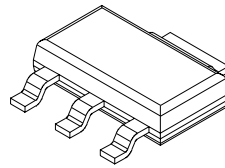
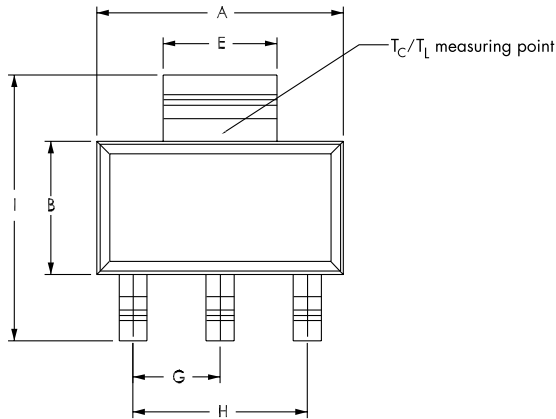

Dimensions in Millimeters (Inches)
Recommended Soldering Footprint
for SOT223

Dimensions	Inches			Millimeters		
	Min	Typ	Max	Min	Typ	Max
A	0.248	0.256	0.264	6.30	6.50	6.70
B	0.130	0.138	0.146	3.30	3.50	3.70
C	—	—	0.071	—	—	1.80
D	0.001	—	0.004	0.02	—	0.10
E	0.114	0.118	0.124	2.90	3.00	3.15
F	0.024	0.027	0.034	0.60	0.70	0.85
G	—	0.090	—	—	2.30	—
H	—	0.181	—	—	4.60	—
I	0.264	0.276	0.287	6.70	7.00	7.30
J	0.009	0.010	0.014	0.24	0.26	0.35
K	10° MAX					

Dimensions – SOT-89

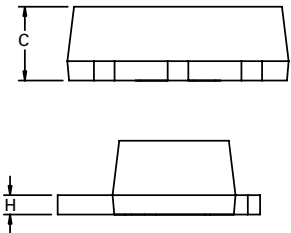
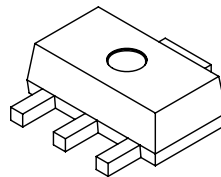
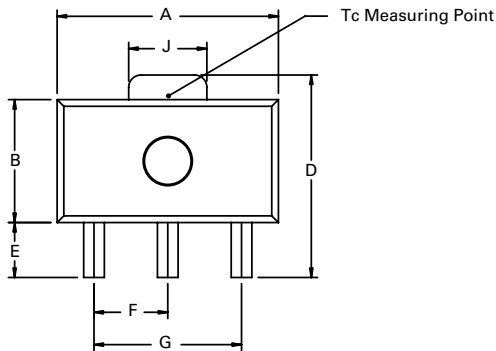

Pad Layout for SOT-89

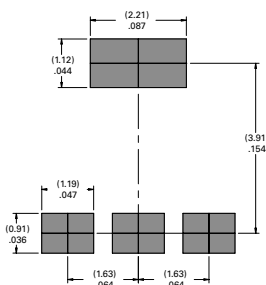

Dimensions in Millimeters (Inches)

Dimension	Inches			Millimeters		
	Min.	Typ	Max	Min	Typ	Max
A	0.173	—	0.181	4.40	—	4.60
B	0.090	—	0.102	2.29	—	2.60
C	0.055	—	0.063	1.40	—	1.60
D	0.115	—	0.121	3.94	—	4.25
E	0.035	—	0.047	0.89	—	1.20
F	0.056	—	0.062	1.42	—	1.57
G	0.115	—	0.121	2.92	—	3.07
H	0.014	—	0.017	0.35	—	0.44
I	0.014	—	0.019	0.36	—	0.48
J	0.064	—	0.072	1.62	—	1.83

Product Selector

Part Number	Voltage			Gate Sensitivity	Package
	400V	600V	800V		
S4X8ES	X	—	—	200 μ A	TO-92
S6X8ES	—	X	—	200 μ A	TO-92
S8X8ES	—	—	X	200 μ A	TO-92
S4X8TS	X	—	—	200 μ A	SOT-223
S6X8TS	—	X	—	200 μ A	SOT-223
S8X8TS	—	—	X	200 μ A	SOT-223
S4X8BS	X	—	—	200 μ A	SOT-89
S6X8BS	—	X	—	200 μ A	SOT-89
S4X8ES1	X	—	—	5 μ A	TO-92
S6X8ES1	—	X	—	5 μ A	TO-92
S8X8ES1	—	—	X	5 μ A	TO-92
S4X8TS1	X	—	—	5 μ A	SOT-223
S6X8TS1	—	X	—	5 μ A	SOT-223
S8X8TS1	—	—	X	5 μ A	SOT-223
S4X8ES2	X	—	—	50 μ A	TO-92
S6X8ES2	—	X	—	50 μ A	TO-92
S8X8ES2	—	—	X	50 μ A	TO-92
S4X8TS2	X	—	—	50 μ A	SOT-223
S6X8TS2	—	X	—	50 μ A	SOT-223
S8X8TS2	—	—	X	50 μ A	SOT-223

Packing Options

Part Number	Marking	Weight	Packing Mode	Base Quantity
SxX8ESy	SxX8ESy	0.170g	Bulk	2500
SxX8ESyAP	SxX8ESy	0.170g	Ammo Pack	2000
SxX8ESyRP	SxX8ESy	0.170g	Tape & Reel	2000
SxX8TSyRP	SxX8TSy	0.120g	Tape & Reel	1000
SxX8BSRP	xX8	0.053g	Tape & Reel	1000

Note: x = voltage, y = gate sensitivity

TO-92 (3-lead) Reel Pack (RP) Radial Leded

Meets all EIA-468-B 1994 Standards

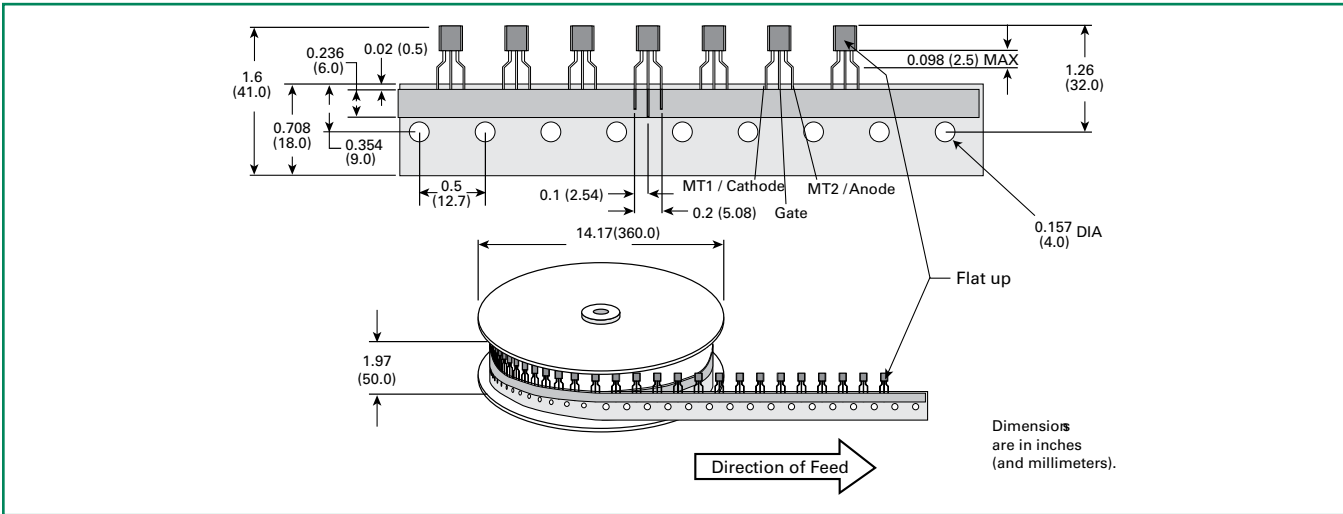

TO-92 (3-lead) Ammo Pack (AP) Radial Leded

Meets all EIA-468-B 1994 Standards

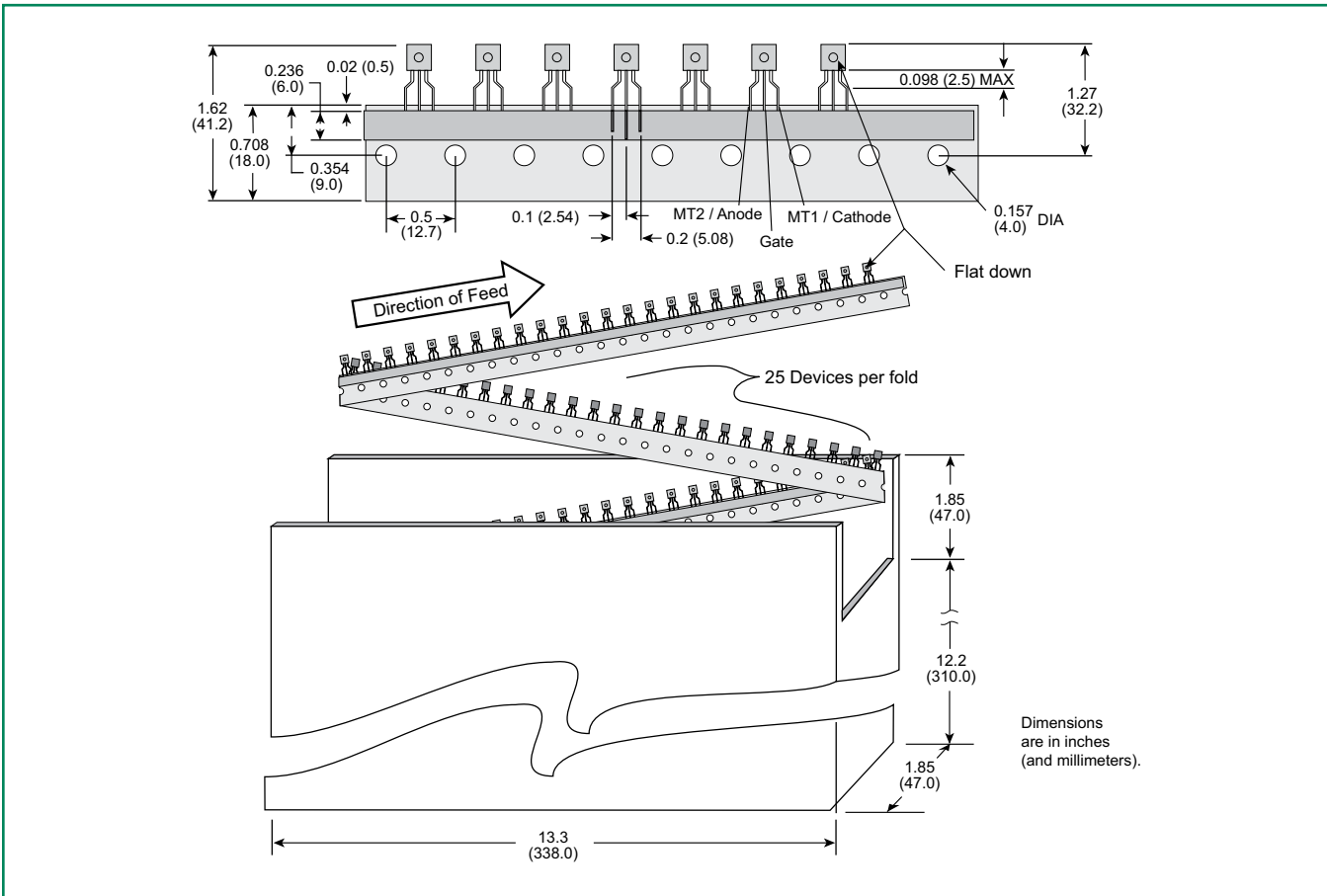

Tape & Reel Specifications for SOT-89

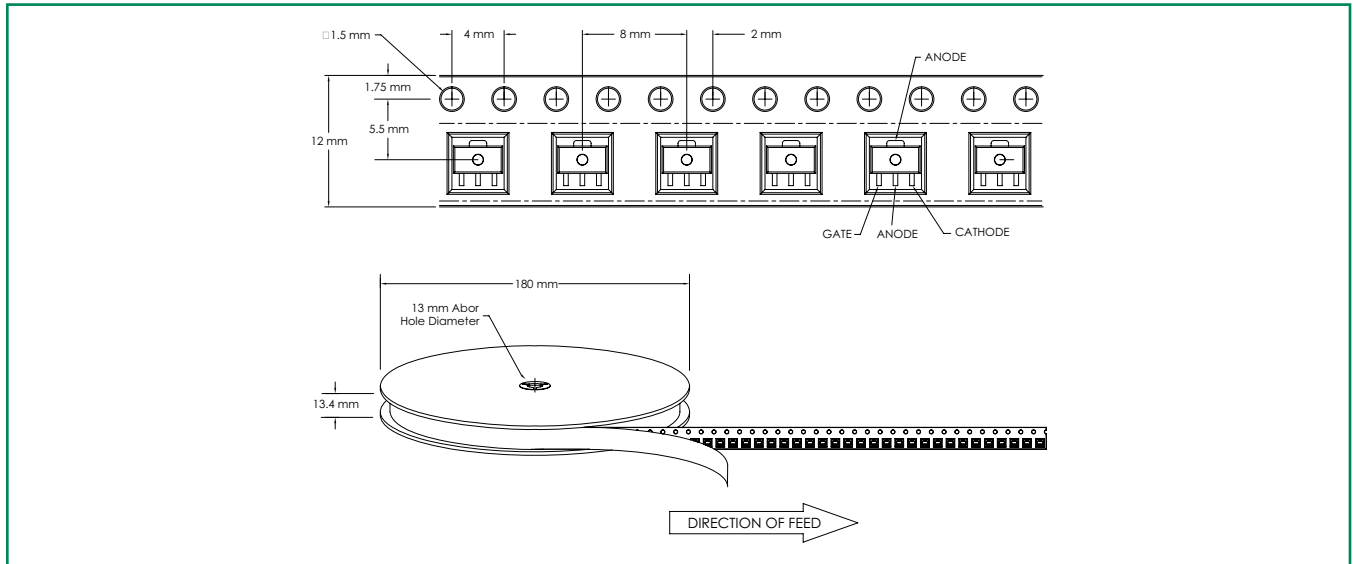

Tape & Reel Specifications for SOT-223

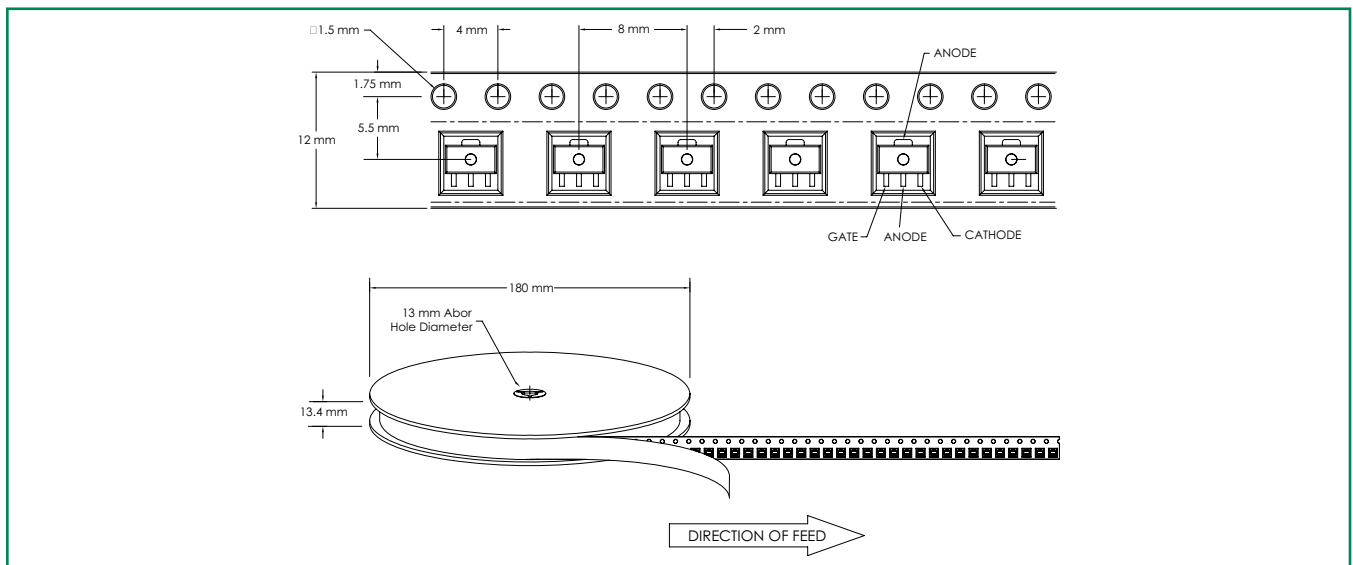

Part Numbering System

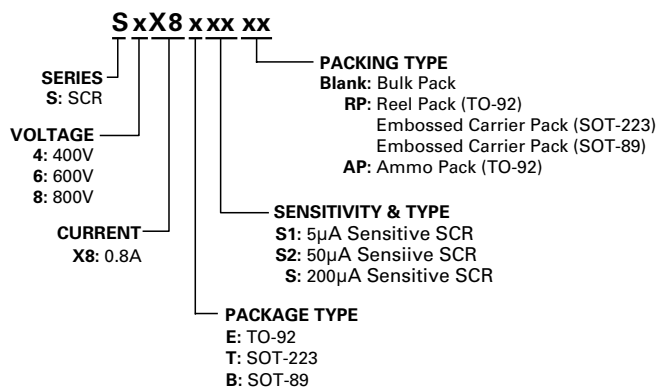

Part Marking System

