

GN2133

CMOS Positive Voltage Regulator

Description

The GN2133 series of positive, linear regulators feature low quiescent current (30µA typ.) with low dropout voltage, making them ideal for battery applications.

These rugged devices have both Thermal Shutdown, and Current Fold-back to prevent device failure under the "Worst" of operating conditions.

The GN2133 is stable with an output capacitance of 2.2µF or greater.

Features

- Very Low Dropout Voltage
- Guaranteed 300mA output
- Over-Temperature Shutdown
- Current Limiting
- Short Circuit Current Fold-back
- Factory Pre-set Output Voltage
- Highly Accurate ± 1.5%
- Low Temperature Coefficient

Applications

- Battery Powered Widgets
- Instrumentation
- Wireless Devices
- Cordless Phones
- PC Peripherals
- Portable Electronics
- Electronic Scales

Block Diagram

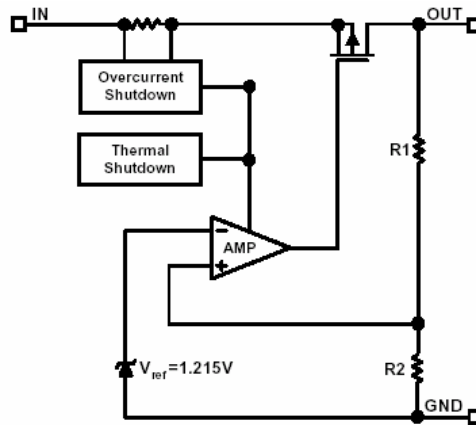

Package Dimensions

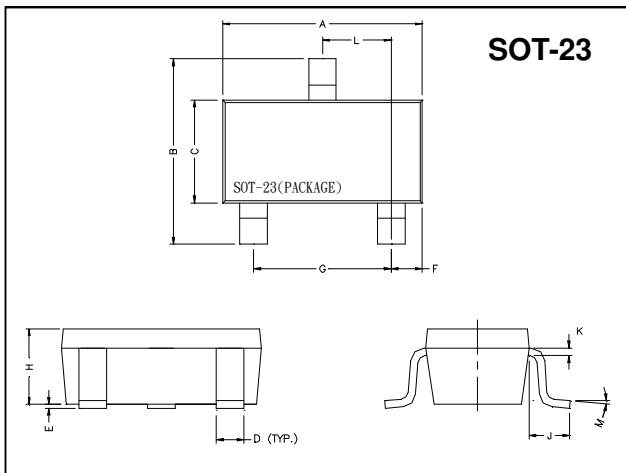

Marking :

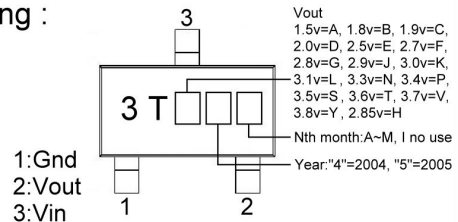

REF.	Millimeter		REF.	Millimeter	
	Min.	Max.		Min.	Max.
A	2.70	3.10	G	1.90	REF.
B	2.40	2.80	H	1.00	1.30
C	1.40	1.60	K	0.10	0.20
D	0.35	0.50	J	0.40	-
E	0	0.10	L	0.85	1.15
F	0.45	0.55	M	0'	10'

Typical Application Circuit

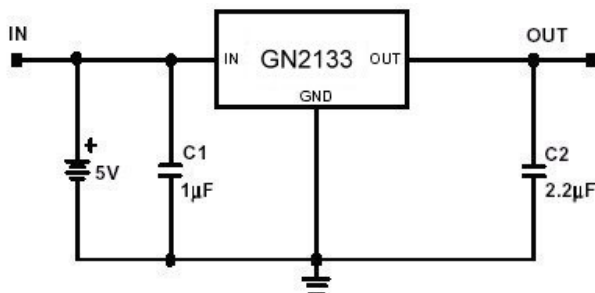

Absolute Maximum Ratings

Parameter	Symbol	Ratings	Unit
Input Voltage	V _{IN}	8	V
Output Current	I _{OUT}	PD/(V _{IN} -V _O)	mA
Output Voltage	V _{OUT}	1.5~3.8	V
Operating Ambient Temperature	T _{opr}	-40 ~ +85	°C
Junction Temperature	T _j	-40 ~ +125	°C
Maximum Junction Temperature	T _{j Max}	150	°C
Thermal Resistance	θ _{jc}	110	°C/W
	θ _{ja}	325	°C/W
Power Dissipation(ΔT=100°C)	PD	300	mW
EDS Classification		B	

Electrical Characteristics Ta=25°C

Parameter	Symbol	Condition	Min	TYP	Max	Unit	
Output Voltage	V _{OUT(E)} (Note1)	V _{IN} =V _{OUT(T)} +1V, I _O =1mA	-1.5%	V _{OUT(T)} (Note2)	1.5%	V	
Output Current	I _O	V _{IN} =V _{OUT(T)} +2V, V _{OUT} ≥V _{OUT(E)} *0.96	300	-	-	mA	
Current Limit	I _{LIM}	V _O >1.2V	300	450	-	mA	
Load Regulation	REG _{LOAD}	V _{IN} =V _{OUT(T)} +2V, I _O =1mA to 300mA	-1	0.2	1	%	
Dropout Voltage	V _{DROPOUT}	I _O =300mA V _O =V _{OUT(E)} -2%	1.3V≤V _{OUT(T)} ≤2.0V	-	-	1300	mV
			2.0V<V _{OUT(T)} ≤2.8V	-	-	400	
			2.8V<V _{OUT(T)}	-	-	300	
Quiescent Current	I _Q	V _{IN} =V _{OUT(T)} +1V	-	30	50	μA	
Line Regulation	REG _{LINE}	I _O =1mA V _{IN} =V _{OUT(T)} +1 to V _{OUT(T)} +2	1.3V≤V _{OUT(T)} ≤1.4V	-0.2	-	0.2	%
			1.4V<V _{OUT(T)} ≤2.0V	-0.15	-	0.15	
			2.0V<V _{OUT(T)} <4.0V	-0.1	0.02	0.1	
			4.0V≤V _{OUT(T)}	-0.4	0.2	0.4	
Input Voltage	V _{IN}		Note3	-	7	V	
Over Temperature Shutdown	OTS		-	150	-	°C	
Over Temperature Hysteresis	OTH		-	30	-	°C	
Output Voltage Temperature Coefficient	TC		-	30	-	ppm/°C	
Short Circuit Current(Note4)	I _{SC}	V _{IN} =V _{OUT(T)} +1V V _{OUT} =0V	-	150	300	mA	
	PSRR	I _O =100mA C _O =2.2μF	f=1kHz	-	50	-	dB
			f=10kHz	-	20	-	
			f=100kHz	-	15	-	
Output Voltage Noise	e _N	f=10Hz~100kHz I _O =10mA				μVrms	
		C _O =2.2μF	-	30	-		

Note 1: V_{OUT(E)} =Effective Output Voltage (i.e. the output voltage when "V_{OUT(T)} +1.0V" is provided at the V_{IN} pin while maintaining a certain I_{OUT} value).

2: V_{OUT(T)} =Specified Output Voltage

3: V_{IN(MIN)} =V_{OUT}+V_{DROPOUT}

4: To prevent the Short Circuit Current protection feature from being prematurely activated, the input voltage must be applied before a current source load is applied.

Ordering Information (contd.)

Part Number	Marking	Output Voltage	Part Number	Marking	Output Voltage
GN2133-15	3TAXX	1.5V	GN2133-18	3TBXX	1.8V
GN2133-19	3TCXX	1.9V	GN2133-20	3TDXX	2.0V
GN2133-25	3TEXX	2.5V	GN2133-27	3TFXX	2.7V
GN2133-28	3TGXX	2.8V	GN2133-2H	3THXX	2.85V
GN2133-29	3TJXX	2.9V	GN2133-30	3TKXX	3.0V
GN2133-31	3TLXX	3.1V	GN2133-33	3TNXX	3.3V
GN2133-34	3TPXX	3.4V	GN2133-35	3TSXX	3.5V
GN2133-36	3TTXX	3.6V	GN2133-37	3TVXX	3.7V
GN2133-38	3TYXX	3.8V			

Characteristics Curve

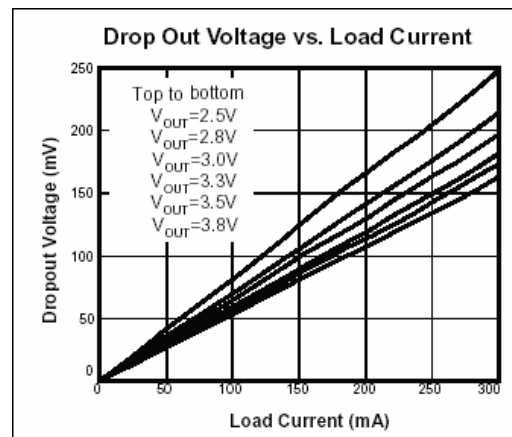
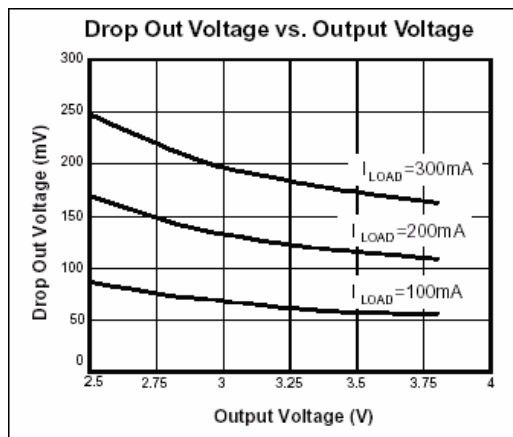
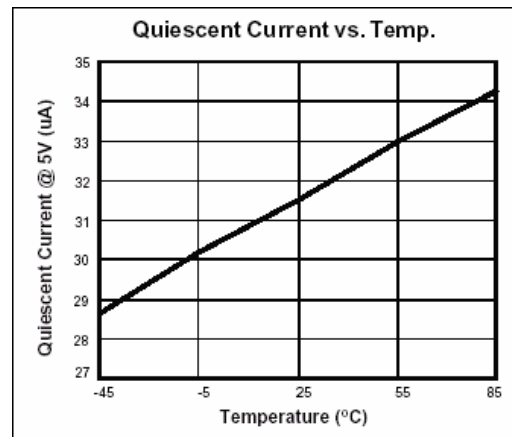
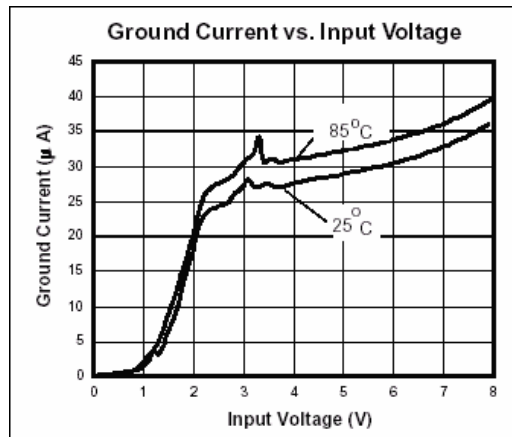

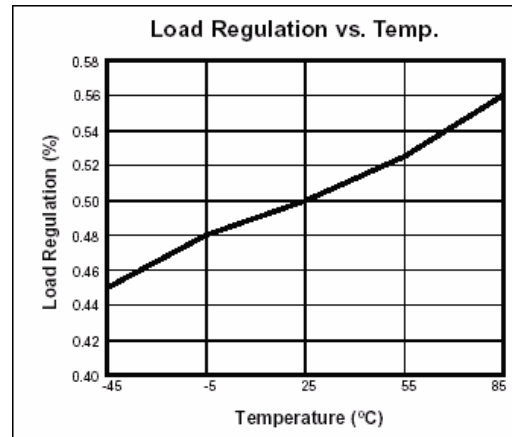
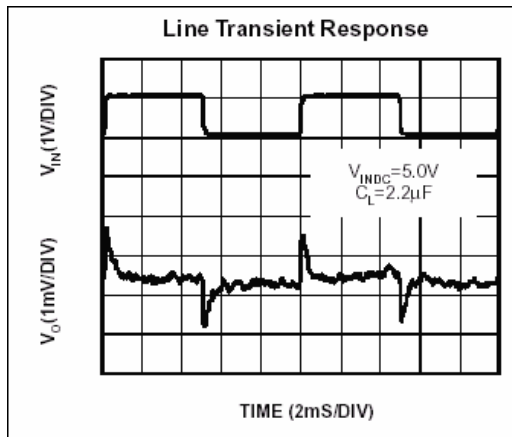
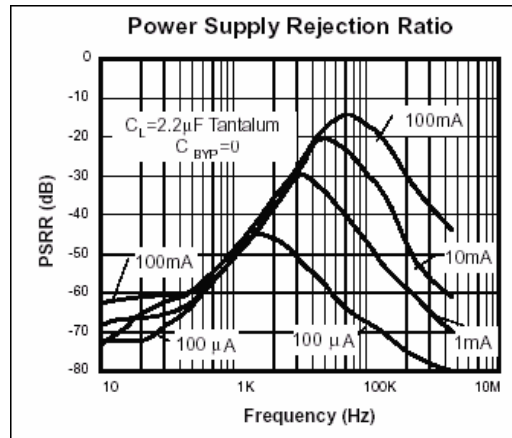
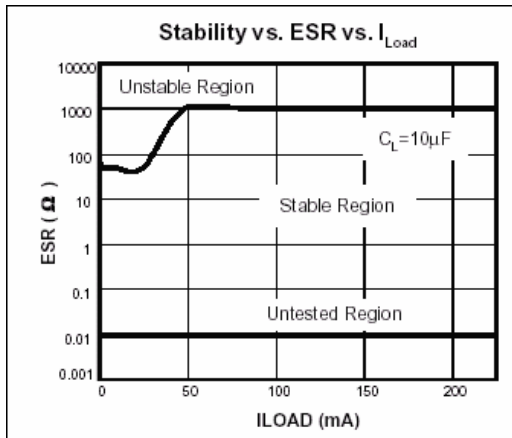
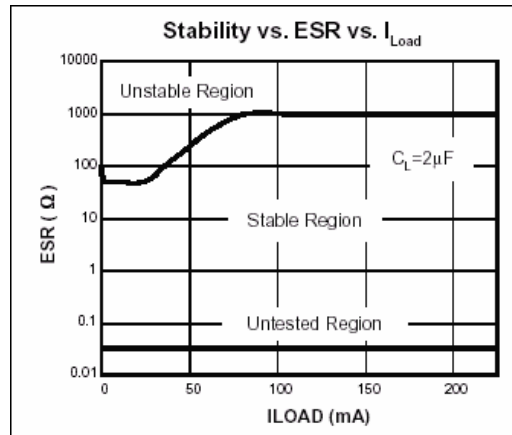
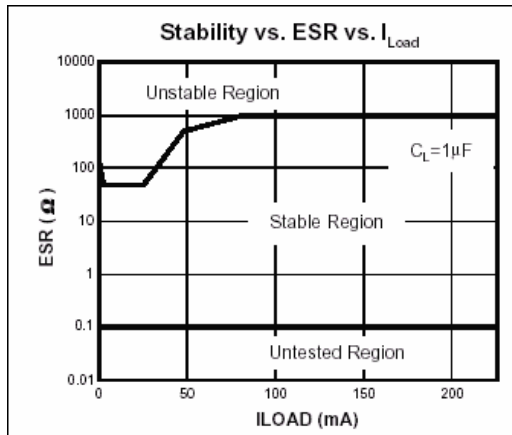

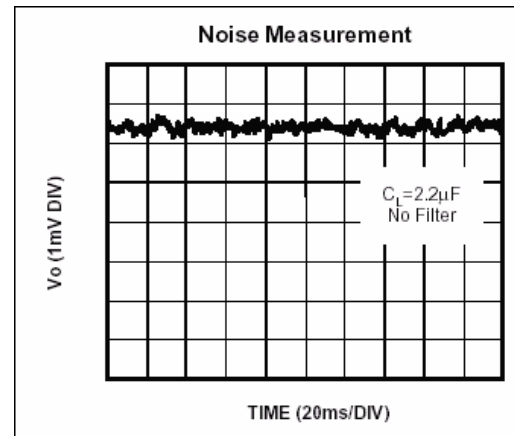
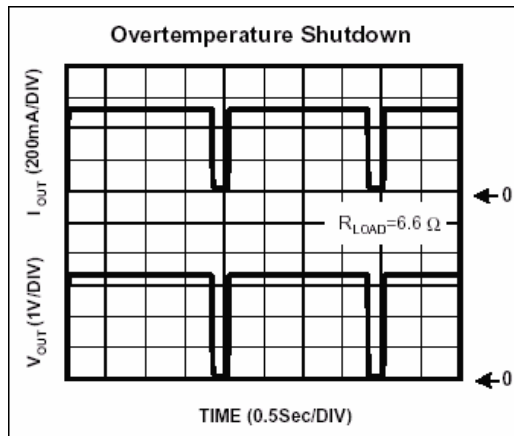
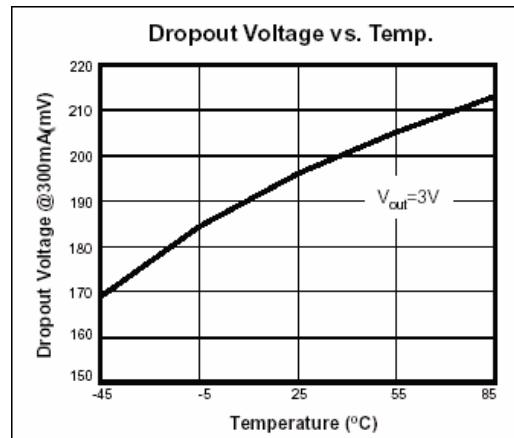
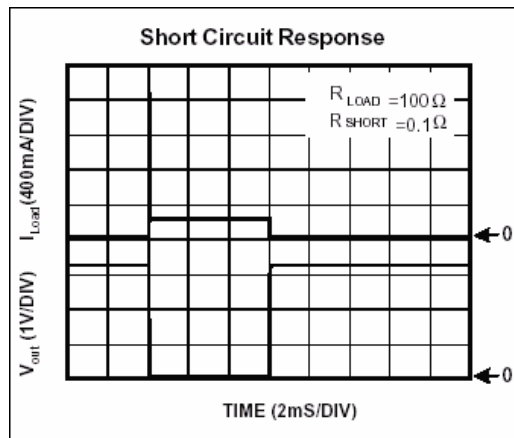
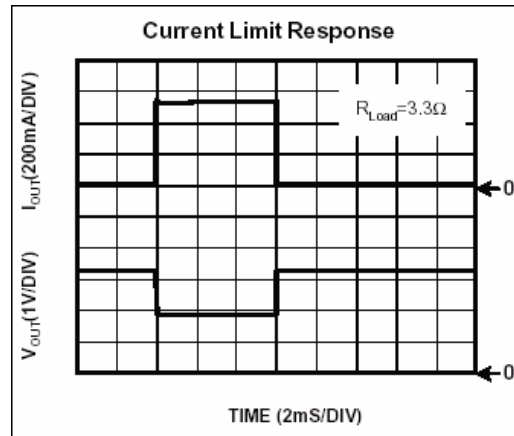
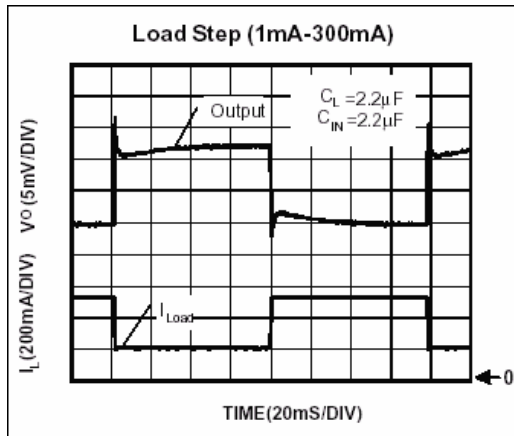

Important Notice:

- All rights are reserved. Reproduction in whole or in part is prohibited without the prior written approval of GTM.
- GTM reserves the right to make changes to its products without notice.
- GTM semiconductor products are not warranted to be suitable for use in life-support Applications, or systems.
- GTM assumes no liability for any consequence of customer product design, infringement of patents, or application assistance.

Head Office And Factory:

- Taiwan: No. 17-1 Tatung Rd. Fu Kou Hsin-Chu Industrial Park, Hsin-Chu, Taiwan, R. O. C.
- TEL : 886-3-597-7061 FAX : 886-3-597-9220, 597-0785
- China: (201203) No.255, Jang-Jiang Tsai-Lueng RD., Pu-Dung-Hsin District, Shang-Hai City, China
- TEL : 86-21-5895-7671 ~ 4 FAX : 86-21-38950165