

BCR12KM-14LA

Triac

Medium Power Use

REJ03G0335-0100

Rev.1.00

Aug.20.2004

Features

- $I_{T(RMS)}$: 12 A
- V_{DRM} : 700 V
- I_{FGTI} , I_{RGTI} , I_{RGTIII} : 30 mA
- V_{ISO} : 2000 V
- Insulated Type
- Planar Passivation Type
- UL Recognized : Yellow Card No. E223904
File No. E80271

Outline

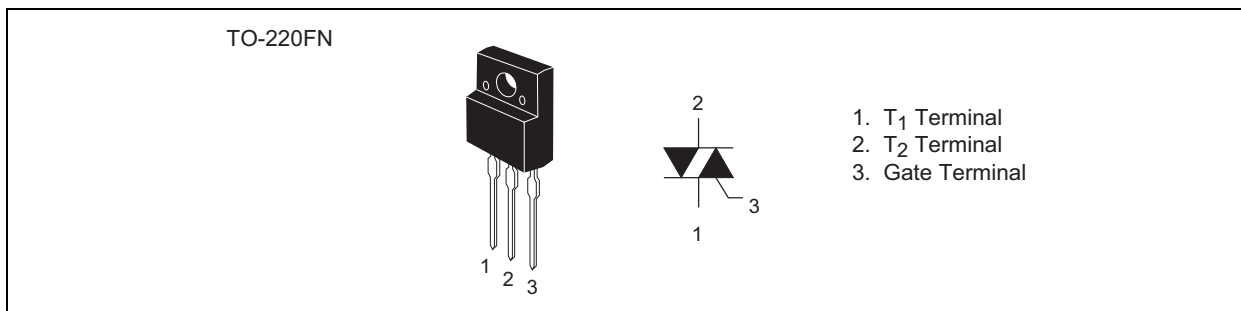

Applications

Switching mode power supply, washing machine, motor control, heater control, and other general purpose control applications

Maximum Ratings

| Parameter | Symbol | Voltage class | Unit |
|--|-----------|---------------|------|
| | | 14 | |
| Repetitive peak off-state voltage ^{Note1} | V_{DRM} | 700 | V |
| Non-repetitive peak off-state voltage ^{Note1} | V_{DSM} | 840 | V |

| Parameter | Symbol | Ratings | Unit | Conditions |
|--------------------------------|--------------|--------------|----------------------|--|
| RMS on-state current | $I_{T(RMS)}$ | 12 | A | Commercial frequency, sine full wave 360° conduction, $T_c = 77^\circ\text{C}$ |
| Surge on-state current | I_{TSM} | 120 | A | 60Hz sinewave 1 full cycle, peak value, non-repetitive |
| I^2t for fusing | I^2t | 60 | A^2s | Value corresponding to 1 cycle of half wave 60Hz, surge on-state current |
| Peak gate power dissipation | P_{GM} | 5 | W | |
| Average gate power dissipation | $P_{G(AV)}$ | 0.5 | W | |
| Peak gate voltage | V_{GM} | 10 | V | |
| Peak gate current | I_{GM} | 2 | A | |
| Junction temperature | T_j | - 40 to +125 | $^\circ\text{C}$ | |
| Storage temperature | T_{stg} | - 40 to +125 | $^\circ\text{C}$ | |
| Mass | — | 2.0 | g | Typical value |
| Isolation voltage | Viso | 2000 | V | $T_a = 25^\circ\text{C}$, AC 1 minute, T_1 - T_2 -G terminal to case |

Notes: 1. Gate open.

Electrical Characteristics

| Parameter | Symbol | Min. | Typ. | Max. | Unit | Test conditions | |
|---|---------------|--------------|------|------|------------------------|---|---|
| Repetitive peak off-state current | I_{DRM} | — | — | 2.0 | mA | $T_j = 125^\circ\text{C}$, V_{DRM} applied | |
| On-state voltage | V_{TM} | — | — | 1.6 | V | $T_c = 25^\circ\text{C}$, $I_{TM} = 20\text{ A}$, Instantaneous measurement | |
| Gate trigger voltage ^{Note2} | I | V_{FGTI} | — | — | 1.5 | V | $T_j = 25^\circ\text{C}$, $V_D = 6\text{ V}$, $R_L = 6\ \Omega$, $R_G = 330\ \Omega$ |
| | II | V_{RGTI} | — | — | 1.5 | V | |
| | III | V_{RGTIII} | — | — | 1.5 | V | |
| Gate trigger current ^{Note2} | I | I_{FGTI} | — | — | 30 | mA | $T_j = 25^\circ\text{C}$, $V_D = 6\text{ V}$, $R_L = 6\ \Omega$, $R_G = 330\ \Omega$ |
| | II | I_{RGTI} | — | — | 30 | mA | |
| | III | I_{RGTIII} | — | — | 30 | mA | |
| Gate non-trigger voltage | V_{GD} | 0.2 | — | — | V | $T_j = 125^\circ\text{C}$, $V_D = 1/2 V_{DRM}$ | |
| Thermal resistance | $R_{th(j-c)}$ | — | — | 3.3 | $^\circ\text{C/W}$ | Junction to case ^{Note3} | |
| Critical-rate of rise of off-state commutating voltage ^{Note4} | $(dv/dt)_c$ | 10 | — | — | $\text{V}/\mu\text{s}$ | $T_j = 125^\circ\text{C}$ | |

Notes: 2. Measurement using the gate trigger characteristics measurement circuit.

3. The contact thermal resistance $R_{th(c-f)}$ in case of greasing is 0.5°C/W .

4. Test conditions of the critical-rate of rise of off-state commutating voltage is shown in the table below.

| Test conditions | Commutating voltage and current waveforms (inductive load) |
|---|--|
| 1. Junction temperature $T_j = 125^\circ\text{C}$ 2. Rate of decay of on-state commutating current $(di/dt)_c = -6\text{ A/ms}$ 3. Peak off-state voltage $V_D = 400\text{ V}$ | |

Performance Curves

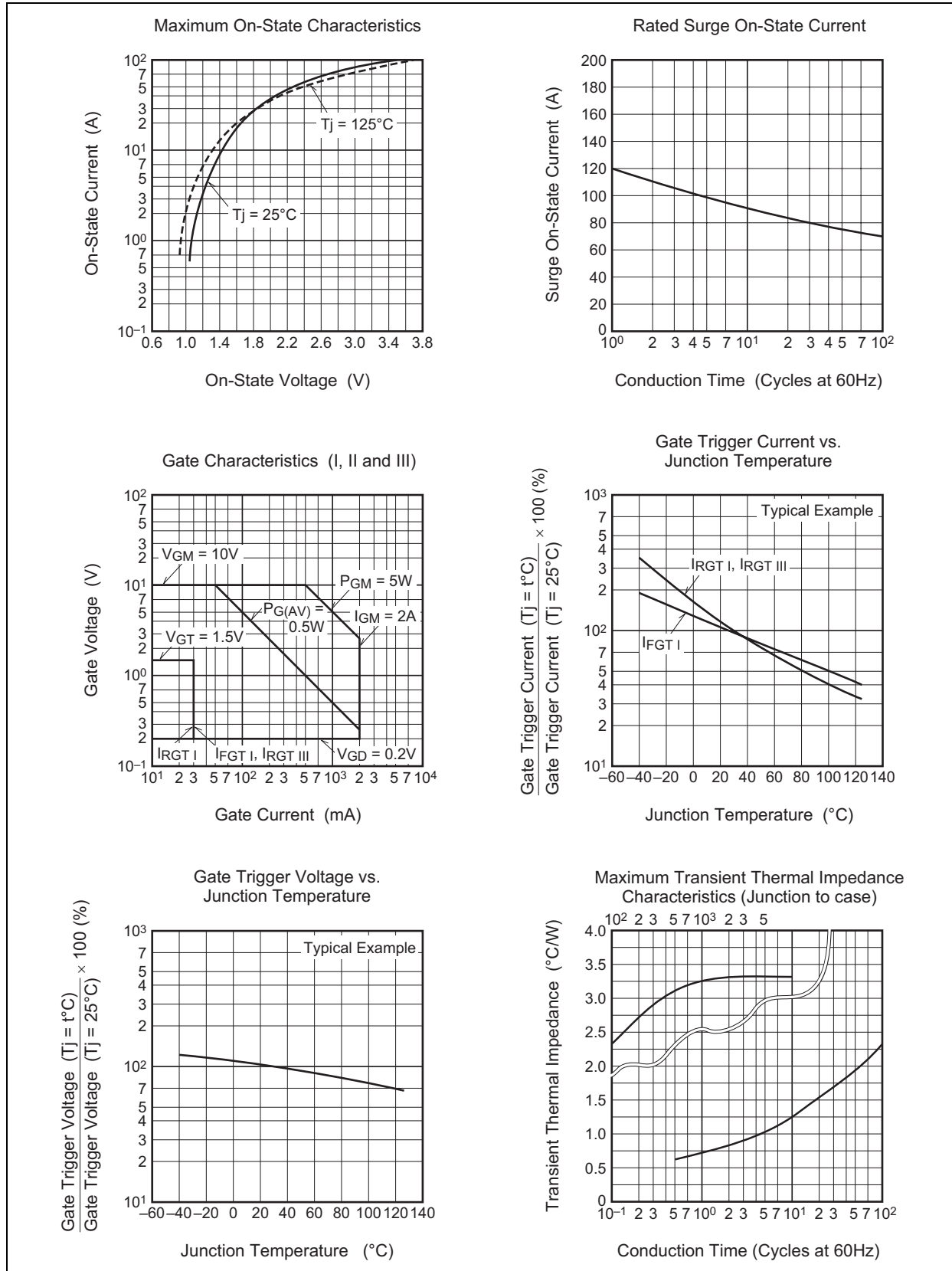

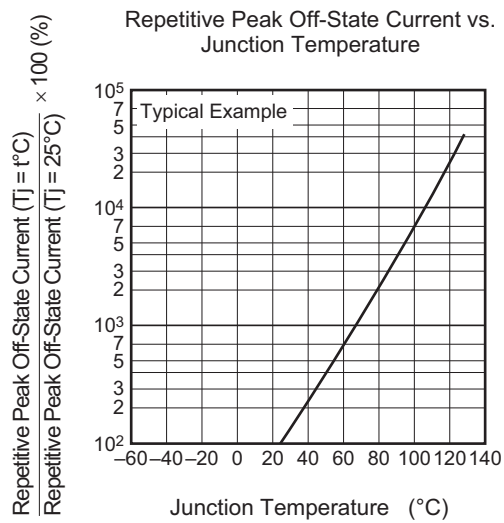
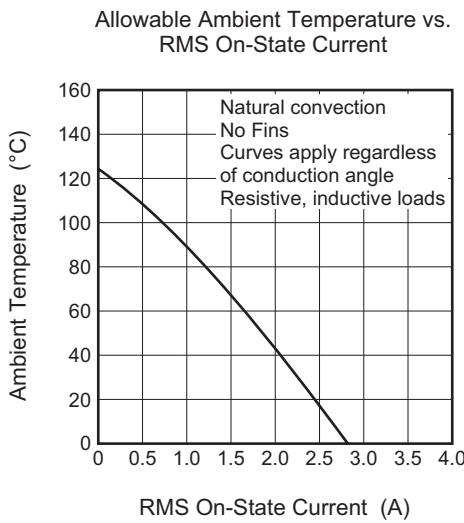
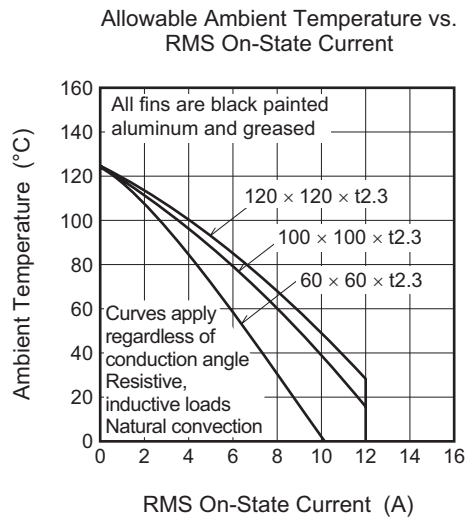
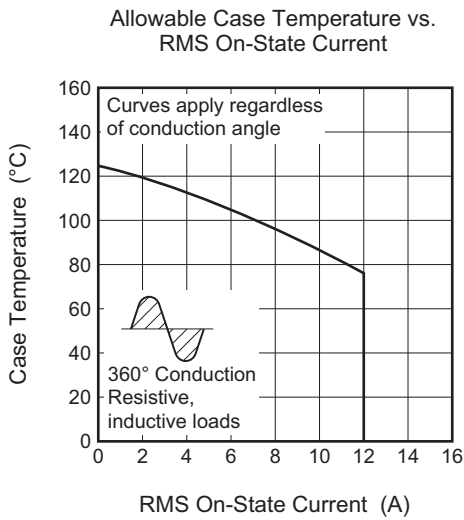
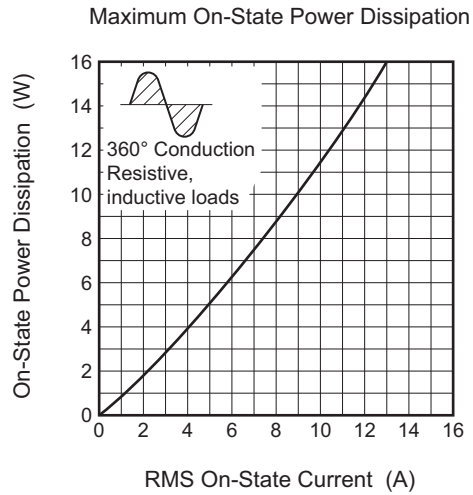
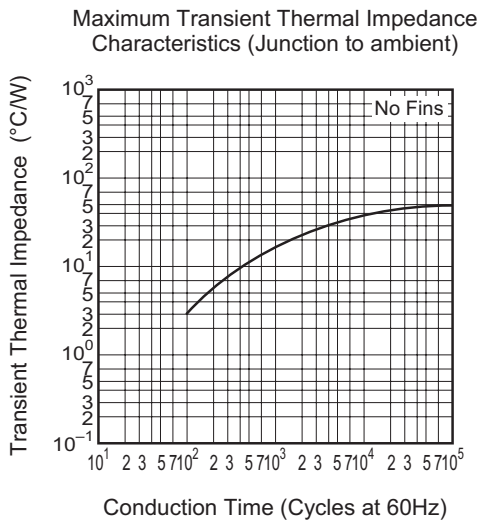

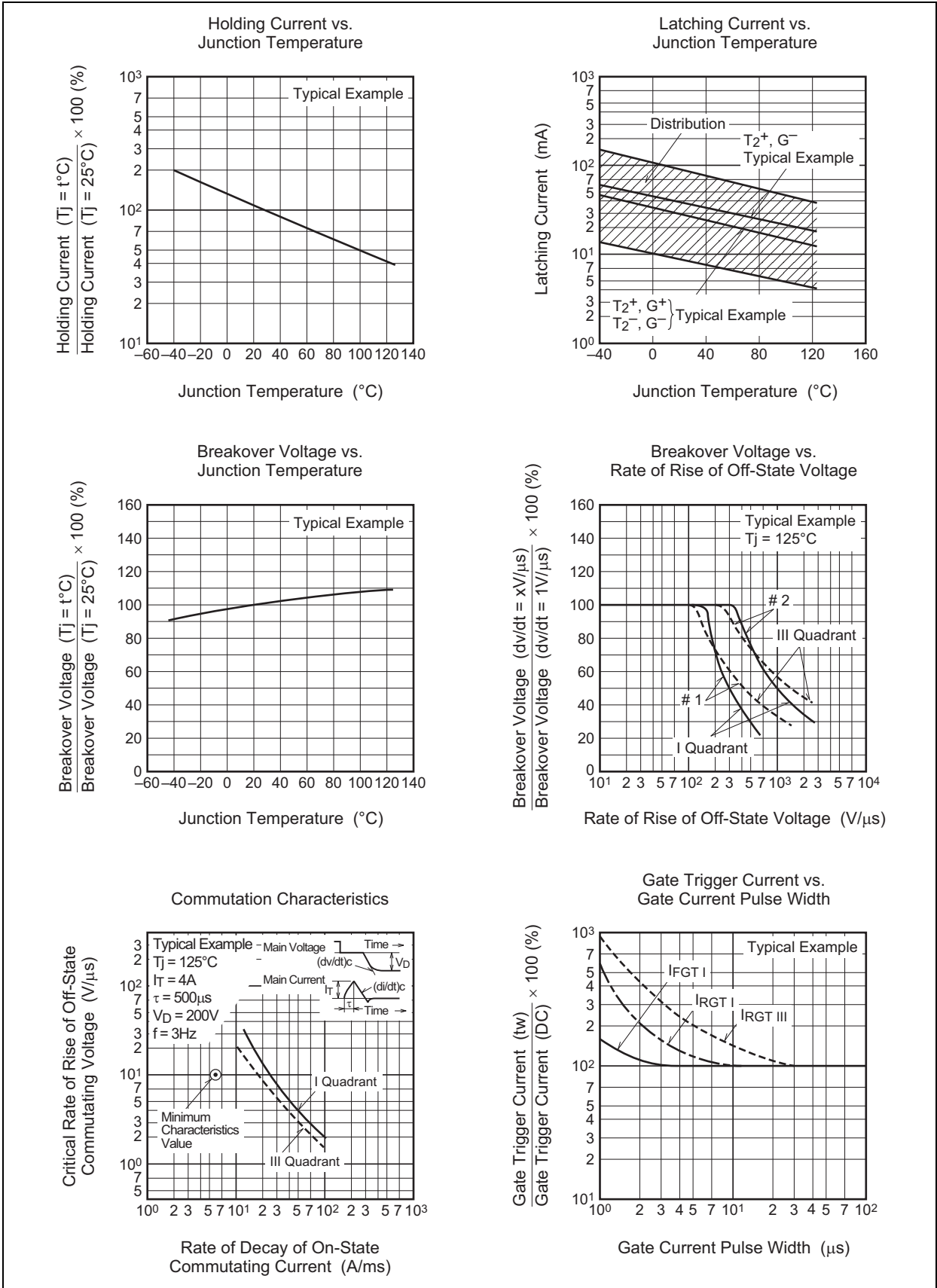

Gate Trigger Characteristics Test Circuits

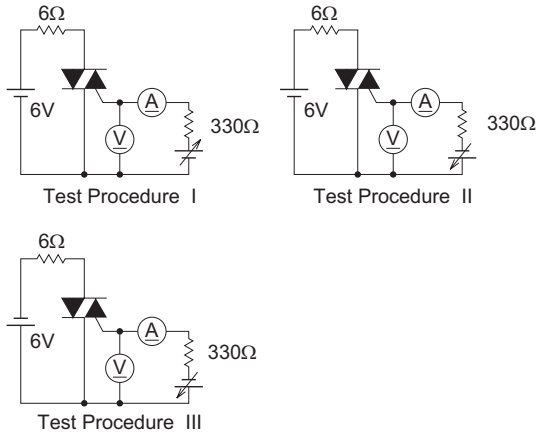

Package Dimensions

TO-220FN

| | | | |
|-------------------|------------|----------------------------|---------------|
| EIAJ Package Code | JEDEC Code | Mass (g) (reference value) | Lead Material |
| — | — | 2.0 | Cu alloy |

| Symbol | Dimension in Millimeters | | |
|--------|--------------------------|-----|-----|
| | Min | Typ | Max |
| A | — | — | — |
| A1 | — | — | — |
| A2 | — | — | — |
| b | — | — | — |
| D | — | — | — |
| E | — | — | — |
| e | — | — | — |
| x | — | — | — |
| y | — | — | — |
| y1 | — | — | — |
| ZD | — | — | — |
| ZE | — | — | — |

Note 1) The dimensional figures indicate representative values unless otherwise the tolerance is specified.

Order Code

| Lead form | Standard packing | Quantity | Standard order code | Standard order code example |
|---------------|-------------------------|----------|-------------------------------|-----------------------------|
| Straight type | Plastic Magazine (Tube) | 50 | Type name | BCR12KM-14LA |
| Lead form | Plastic Magazine (Tube) | 50 | Type name – Lead forming code | BCR12KM-14LA-A8 |

Note : Please confirm the specification about the shipping in detail.

Renesas Technology Corp. Sales Strategic Planning Div. Nippon Bldg., 2-6-2, Ohte-machi, Chiyoda-ku, Tokyo 100-0004, Japan

Keep safety first in your circuit designs!

1. Renesas Technology Corp. puts the maximum effort into making semiconductor products better and more reliable, but there is always the possibility that trouble may occur with them. Trouble with semiconductors may lead to personal injury, fire or property damage.
Remember to give due consideration to safety when making your circuit designs, with appropriate measures such as (i) placement of substitutive, auxiliary circuits, (ii) use of nonflammable material or (iii) prevention against any malfunction or mishap.

Notes regarding these materials

1. These materials are intended as a reference to assist our customers in the selection of the Renesas Technology Corp. product best suited to the customer's application; they do not convey any license under any intellectual property rights, or any other rights, belonging to Renesas Technology Corp. or a third party.
2. Renesas Technology Corp. assumes no responsibility for any damage, or infringement of any third-party's rights, originating in the use of any product data, diagrams, charts, programs, algorithms, or circuit application examples contained in these materials.
3. All information contained in these materials, including product data, diagrams, charts, programs and algorithms represents information on products at the time of publication of these materials, and are subject to change by Renesas Technology Corp. without notice due to product improvements or other reasons. It is therefore recommended that customers contact Renesas Technology Corp. or an authorized Renesas Technology Corp. product distributor for the latest product information before purchasing a product listed herein.
The information described here may contain technical inaccuracies or typographical errors.
Renesas Technology Corp. assumes no responsibility for any damage, liability, or other loss rising from these inaccuracies or errors.
Please also pay attention to information published by Renesas Technology Corp. by various means, including the Renesas Technology Corp. Semiconductor home page (<http://www.renesas.com>).
4. When using any or all of the information contained in these materials, including product data, diagrams, charts, programs, and algorithms, please be sure to evaluate all information as a total system before making a final decision on the applicability of the information and products. Renesas Technology Corp. assumes no responsibility for any damage, liability or other loss resulting from the information contained herein.
5. Renesas Technology Corp. semiconductors are not designed or manufactured for use in a device or system that is used under circumstances in which human life is potentially at stake. Please contact Renesas Technology Corp. or an authorized Renesas Technology Corp. product distributor when considering the use of a product contained herein for any specific purposes, such as apparatus or systems for transportation, vehicular, medical, aerospace, nuclear, or undersea repeater use.
6. The prior written approval of Renesas Technology Corp. is necessary to reprint or reproduce in whole or in part these materials.
7. If these products or technologies are subject to the Japanese export control restrictions, they must be exported under a license from the Japanese government and cannot be imported into a country other than the approved destination.
Any diversion or reexport contrary to the export control laws and regulations of Japan and/or the country of destination is prohibited.
8. Please contact Renesas Technology Corp. for further details on these materials or the products contained therein.



RENESAS SALES OFFICES

<http://www.renesas.com>

Renesas Technology America, Inc.

450 Holger Way, San Jose, CA 95134-1368, U.S.A
Tel: <1> (408) 382-7500 Fax: <1> (408) 382-7501

Renesas Technology Europe Limited.

Dukes Meadow, Millboard Road, Bourne End, Buckinghamshire, SL8 5FH, United Kingdom
Tel: <44> (1628) 585 100, Fax: <44> (1628) 585 900

Renesas Technology Europe GmbH

Dornacher Str. 3, D-85622 Feldkirchen, Germany
Tel: <49> (89) 380 70 0, Fax: <49> (89) 929 30 11

Renesas Technology Hong Kong Ltd.

7/F., North Tower, World Finance Centre, Harbour City, Canton Road, Hong Kong
Tel: <852> 2265-6688, Fax: <852> 2375-6836

Renesas Technology Taiwan Co., Ltd.

FL 10, #99, Fu-Hsing N. Rd., Taipei, Taiwan
Tel: <886> (2) 2715-2888, Fax: <886> (2) 2713-2999

Renesas Technology (Shanghai) Co., Ltd.

26/F., Ruijin Building, No.205 Maoming Road (S), Shanghai 200020, China
Tel: <86> (21) 6472-1001, Fax: <86> (21) 6415-2952

Renesas Technology Singapore Pte. Ltd.

1, Harbour Front Avenue, #06-10, Keppel Bay Tower, Singapore 098632
Tel: <65> 6213-0200, Fax: <65> 6278-8001