

TOSHIBA Transistor Silicon NPN Epitaxial Type (PCT process) (Bias Resistor built-in Transistor)

RN1101FS, RN1102FS, RN1103FS RN1104FS, RN1105FS, RN1106FS

Switching, Inverter Circuit, Interface Circuit and
Driver Circuit Applications

- Incorporating a bias resistor into a transistor reduces parts count. Reducing the parts count enable the manufacture of ever more compact equipment and save assembly cost.
- Complementary to RN2101FS~RN2106FS

Equivalent Circuit and Bias Resistor Values

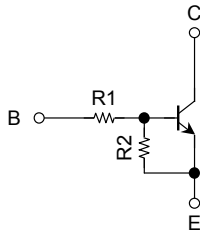

Type No.	R1 (kΩ)	R2 (kΩ)
RN1101FS	4.7	4.7
RN1102FS	10	10
RN1103FS	22	22
RN1104FS	47	47
RN1105FS	2.2	47
RN1106FS	4.7	47

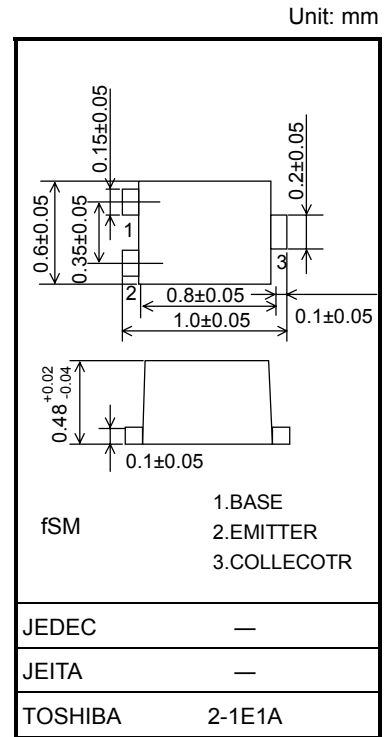

Weight: 0.0006g (typ.)

Maximum Ratings (Ta = 25°C)

Characteristics	Symbol	Rating	Unit
Collector-base voltage	V _{CB0}	20	V
Collector-emitter voltage			
Emitter-base voltage	V _{EB0}	10	V
		5	
Collector current	I _C	50	mA
Collector power dissipation	P _C	50	mW
Junction temperature	T _j	150	°C
Storage temperature range	T _{stg}	-55~150	°C

Electrical Characteristics (Ta = 25°C)

Characteristics		Symbol	Test Condition	Min	Typ.	Max	Unit
Collector cut-off current	RN1101FS~1106FS	I_{CBO}	$V_{CB} = 20\text{ V}, I_E = 0$	—	—	100	nA
		I_{CEO}	$V_{CE} = 20\text{ V}, I_B = 0$	—	—	500	
Emitter cut-off current	RN1101FS	I_{EBO}	$V_{EB} = 10\text{ V}, I_C = 0$	0.89	—	1.33	mA
	RN1102FS			0.41	—	0.63	
	RN1103FS			0.18	—	0.29	
	RN1104FS			0.088	—	0.133	
	RN1105FS		$V_{EB} = 5\text{ V}, I_C = 0$	0.085	—	0.127	
	RN1106FS			0.08	—	0.121	
DC current gain	RN1101FS	h_{FE}	$V_{CE} = 5\text{ V}, I_C = 10\text{ mA}$	30	—	—	
	RN1102FS			60	—	—	
	RN1103FS			100	—	—	
	RN1104FS			120	—	—	
	RN1105FS			120	—	—	
	RN1106FS			120	—	—	
Collector-emitter saturation voltage	RN1101FS~1106FS	$V_{CE(sat)}$	$I_C = 5\text{ mA}, I_B = 0.25\text{ mA}$	—	—	0.15	V
Input voltage (ON)	RN1101FS	$V_{I(ON)}$	$V_{CE} = 0.2\text{ V}, I_C = 5\text{ mA}$	1.0	—	2.0	V
	RN1102FS			1.0	—	2.2	
	RN1103FS			1.1	—	2.7	
	RN1104FS			1.2	—	3.6	
	RN1105FS			0.6	—	1.1	
	RN1106FS			0.6	—	1.2	
Input voltage (OFF)	RN1101FS~1104FS	$V_{I(OFF)}$	$V_{CE} = 5\text{ V}, I_C = 0.1\text{ mA}$	0.8	—	1.5	V
	RN1105FS, 1106FS			0.4	—	0.8	
Collector output capacitance	RN1101FS~1106FS	C_{ob}	$V_{CB} = 10\text{ V}, I_E = 0, f = 1\text{ MHz}$	—	1.2	—	pF
Input resistor	RN1101FS	R1	—	3.76	4.7	5.64	kΩ
	RN1102FS			8	10	12	
	RN1103FS			17.6	22	26.4	
	RN1104FS			37.6	47	56.4	
	RN1105FS			1.76	2.2	2.64	
	RN1106FE			3.76	4.7	5.64	
Resistor ratio	RN1101FS~1104FS	R1/R2	—	0.8	1.0	1.2	
	RN1105FS			0.0376	0.0468	0.0562	
	RN1106FS			0.08	0.1	0.12	

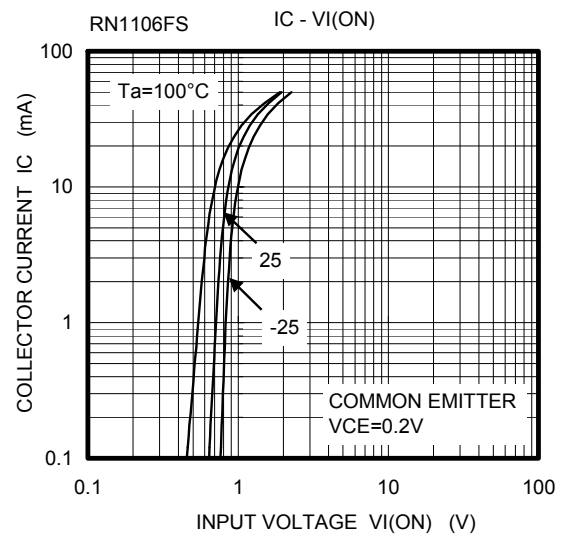
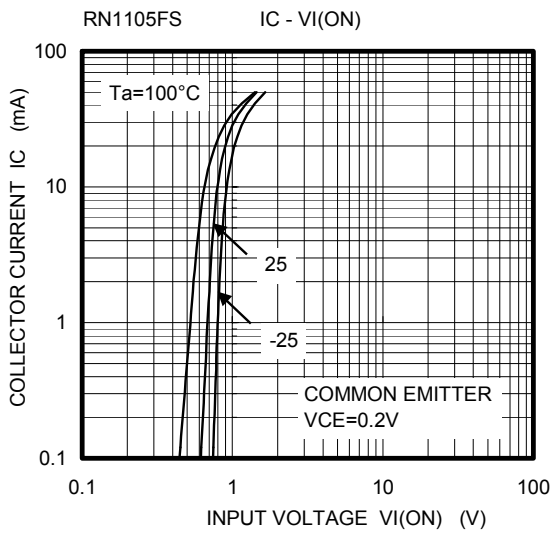
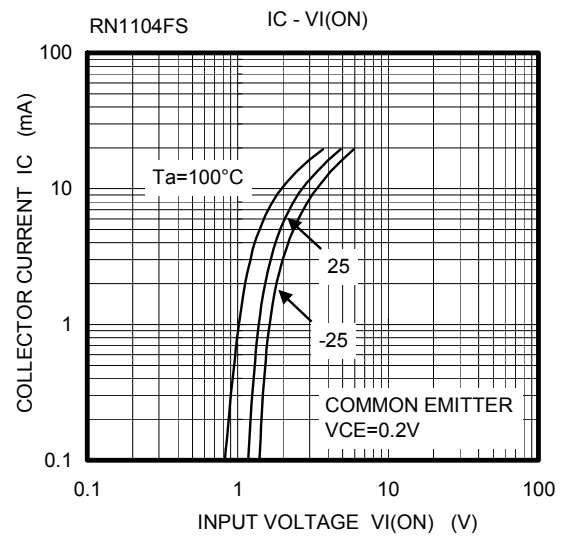
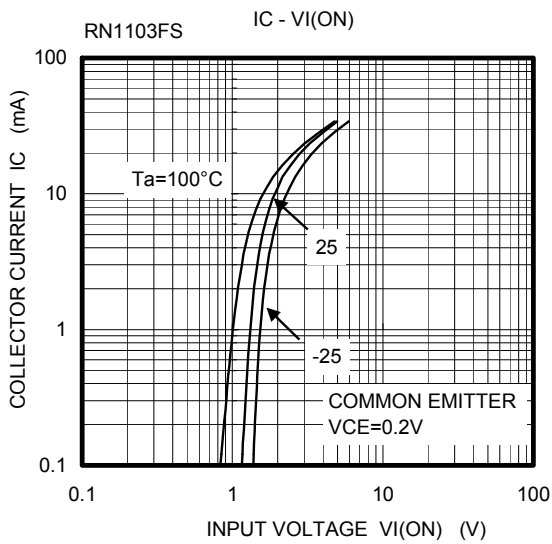
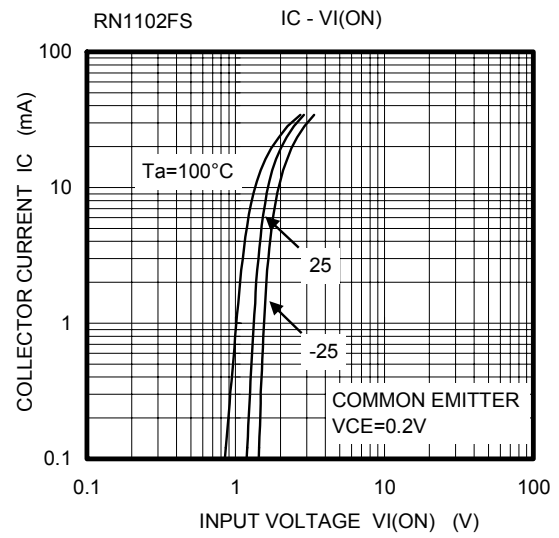
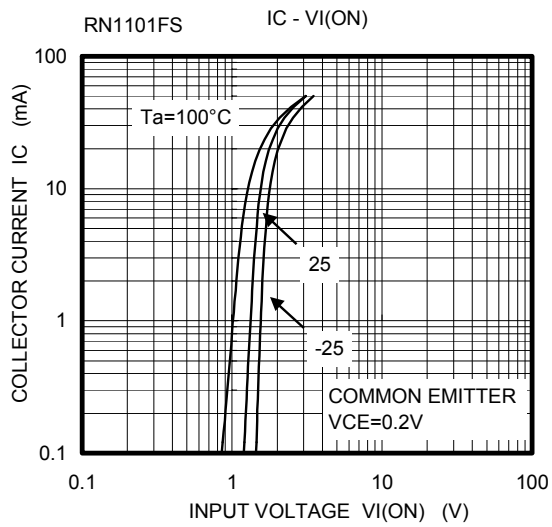

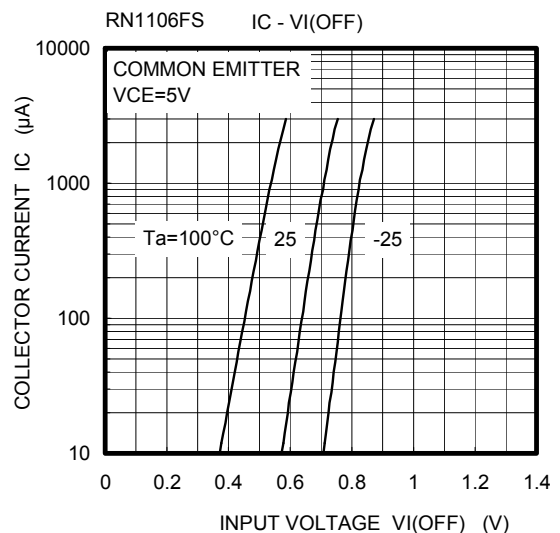
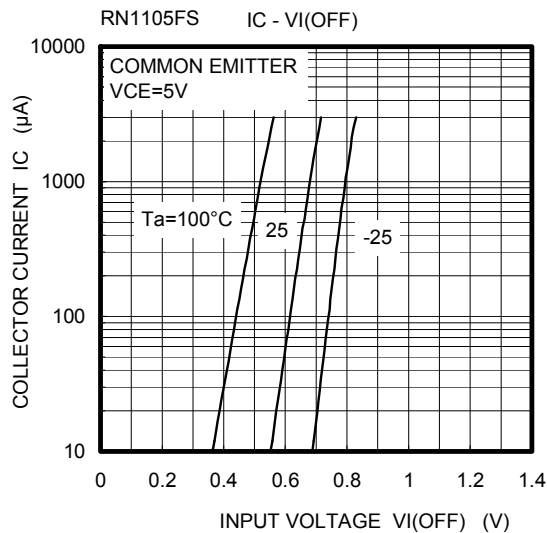
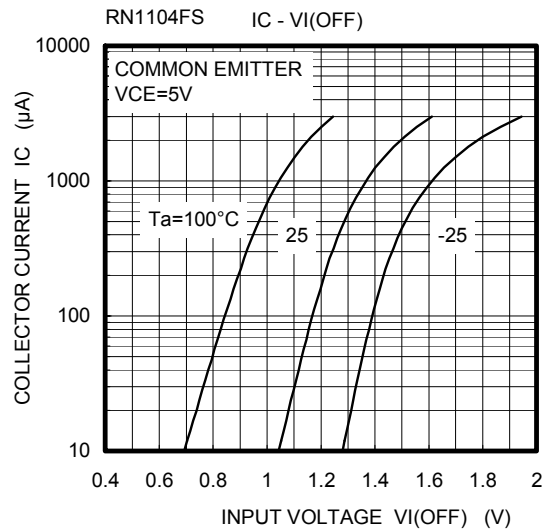
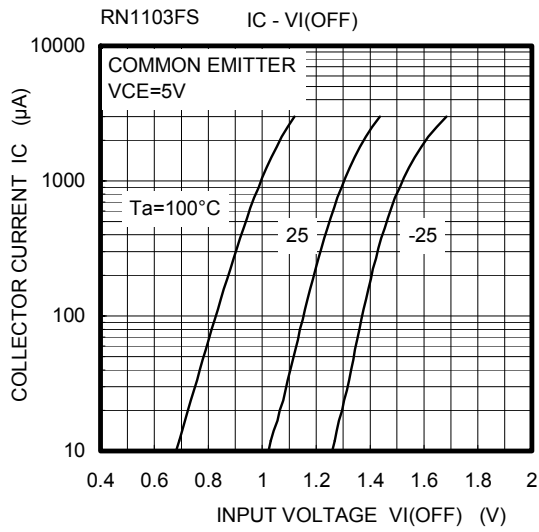
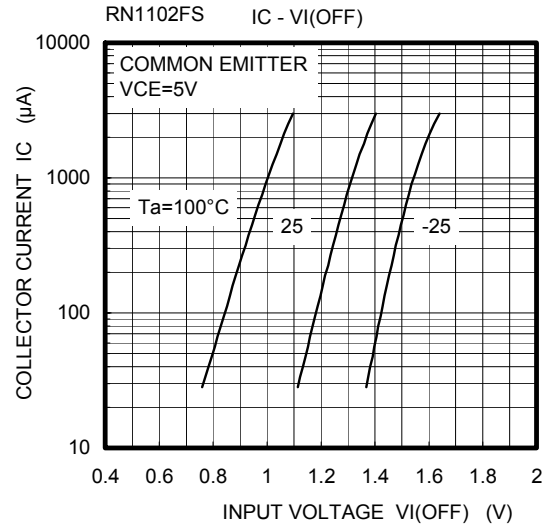
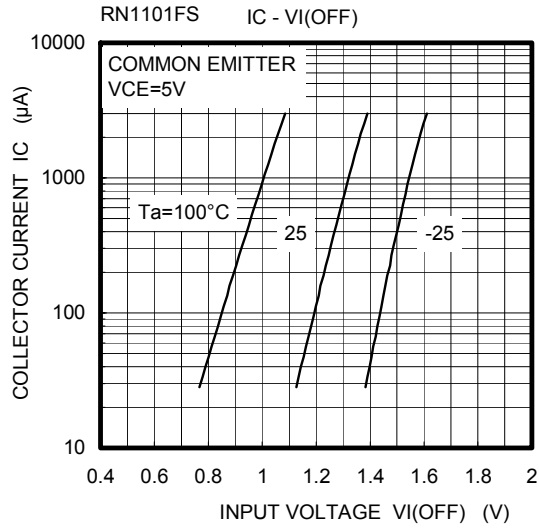

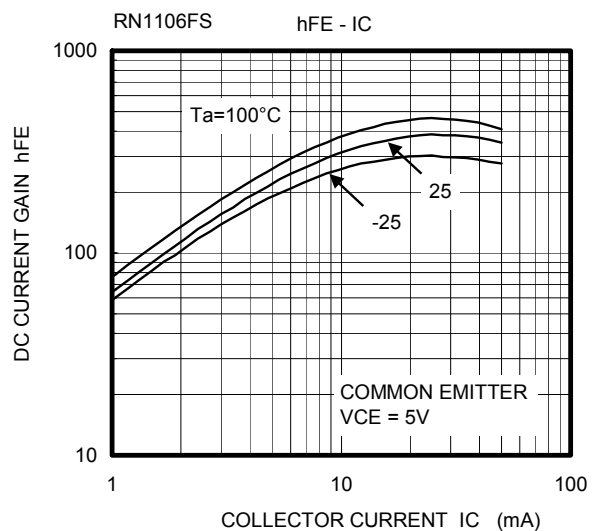
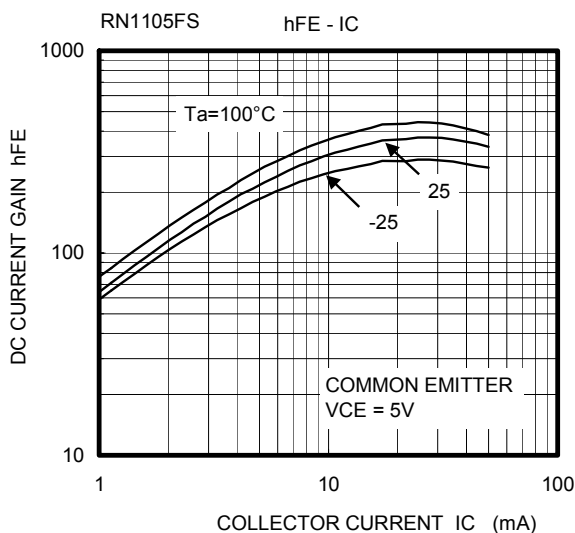
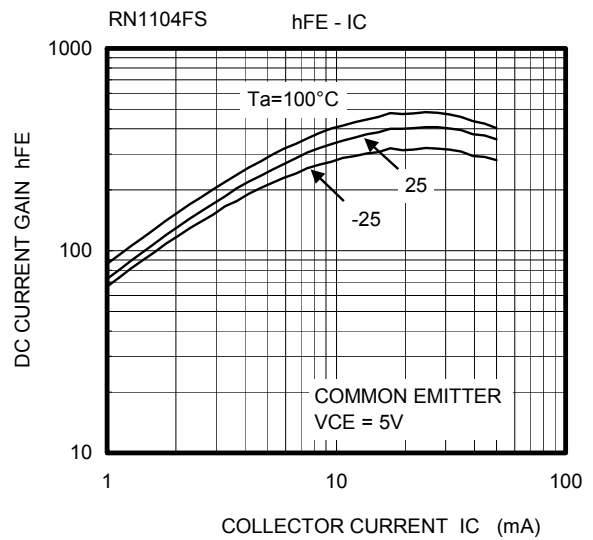
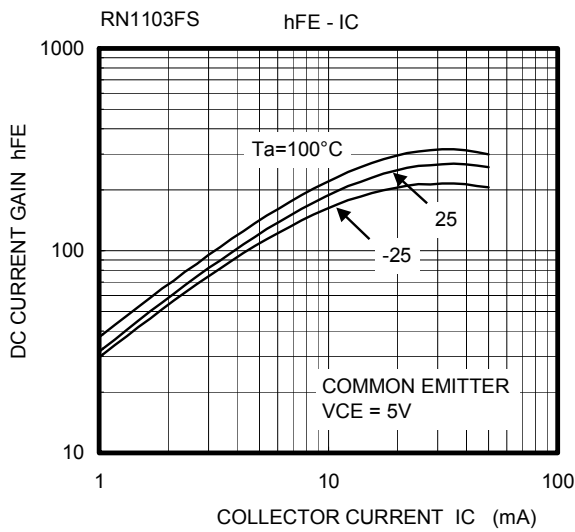
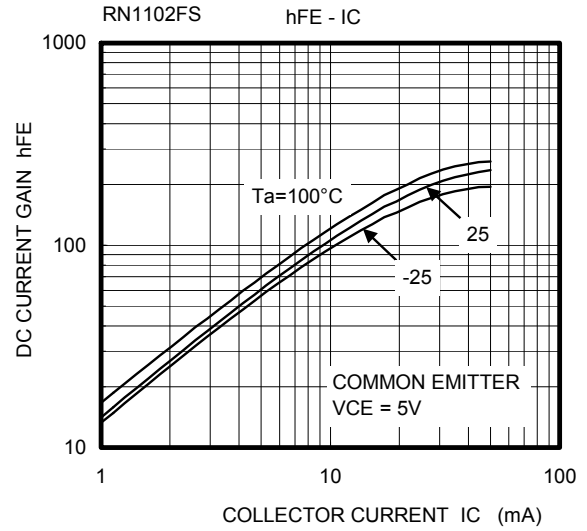
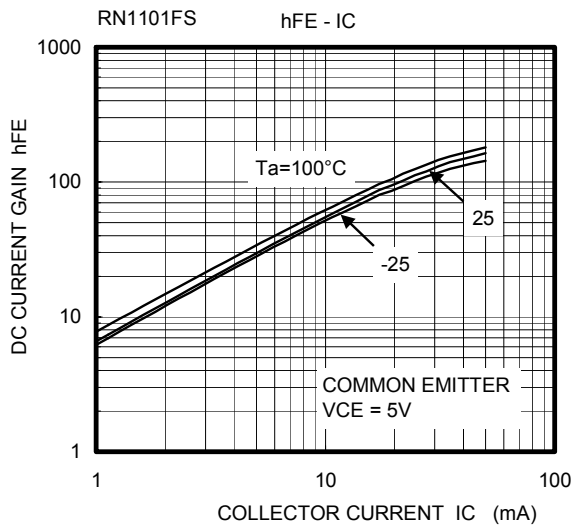

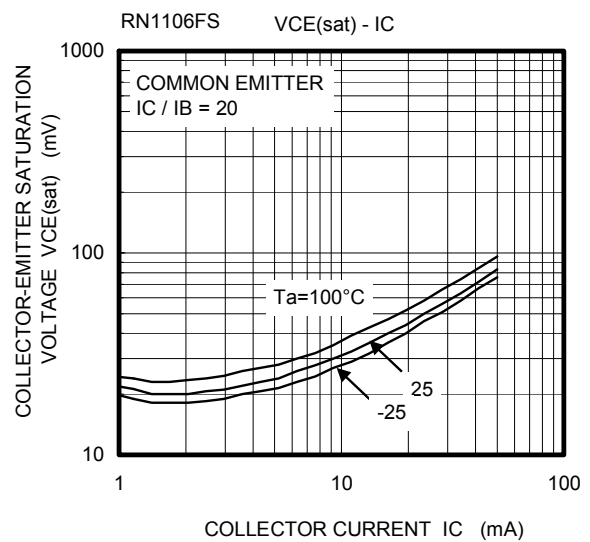
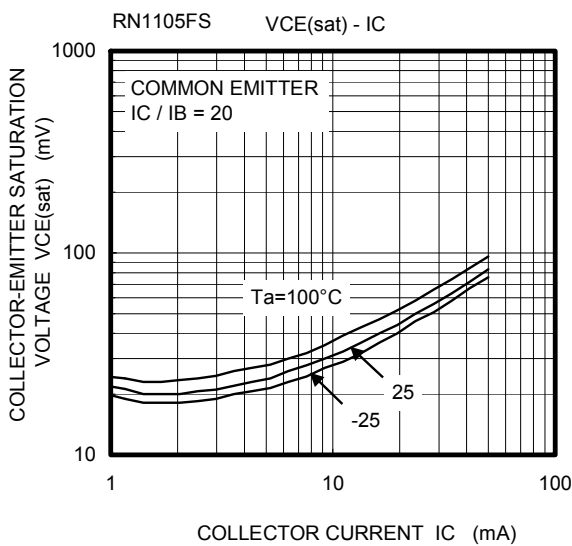
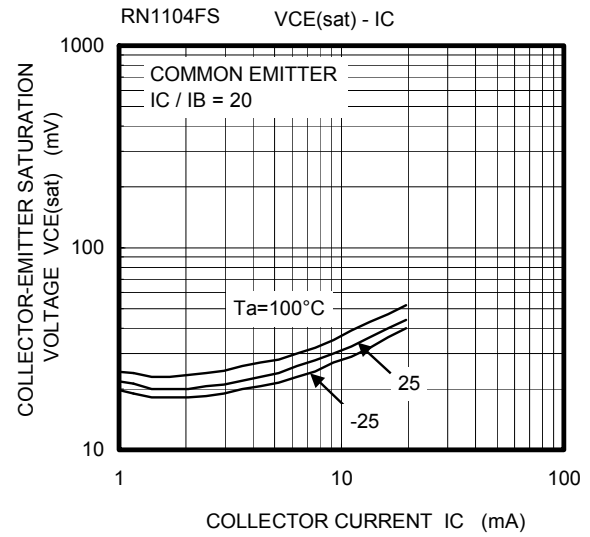
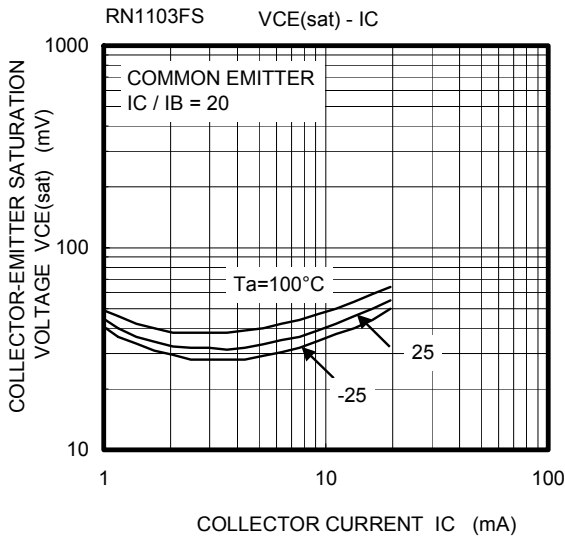
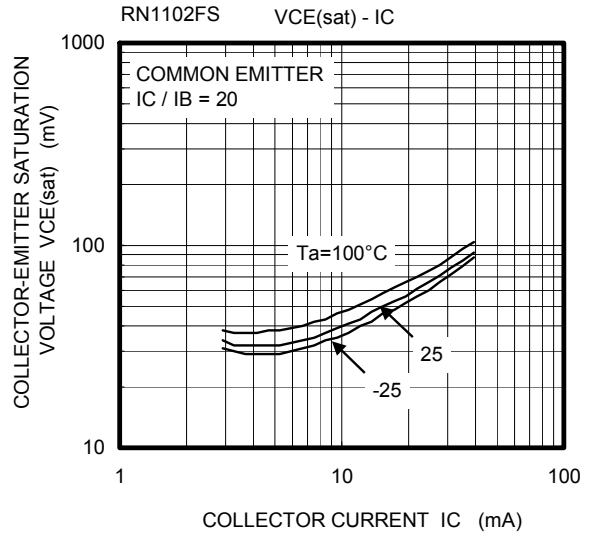
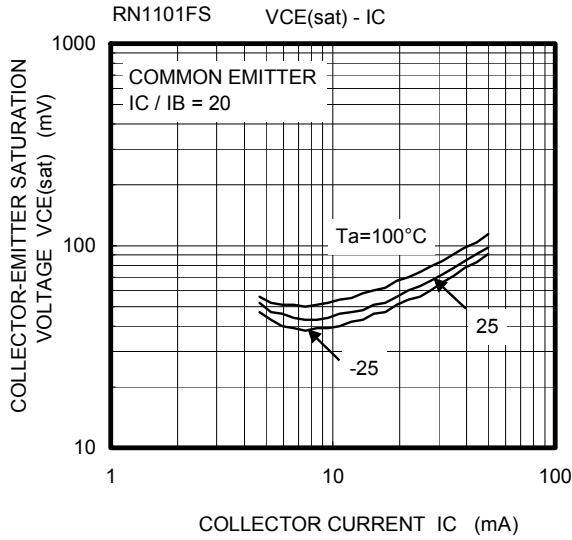

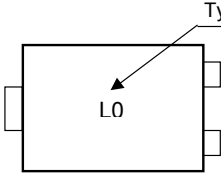
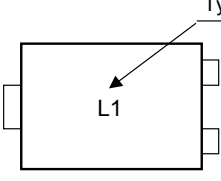
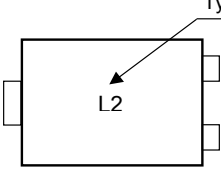
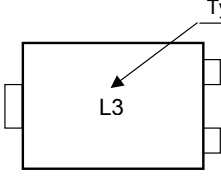
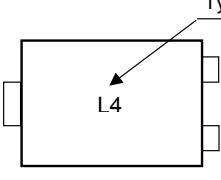
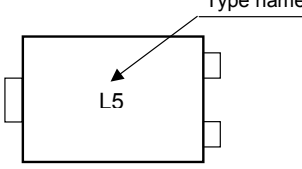
Type Name	Marking
RN1101FS	
RN1102FS	
RN1103FS	
RN1104FS	
RN1105FS	
RN1106FS	

HANDLING PRECAUTION

When handling individual devices (which are not yet mounted on a circuit board), be sure that the environment is protected against electrostatic electricity. Operators should wear anti-static clothing, and containers and other objects that come into direct contact with devices should be made of anti-static materials.

RESTRICTIONS ON PRODUCT USE

030619EAA

- The information contained herein is subject to change without notice.
- The information contained herein is presented only as a guide for the applications of our products. No responsibility is assumed by TOSHIBA for any infringements of patents or other rights of the third parties which may result from its use. No license is granted by implication or otherwise under any patent or patent rights of TOSHIBA or others.
- TOSHIBA is continually working to improve the quality and reliability of its products. Nevertheless, semiconductor devices in general can malfunction or fail due to their inherent electrical sensitivity and vulnerability to physical stress. It is the responsibility of the buyer, when utilizing TOSHIBA products, to comply with the standards of safety in making a safe design for the entire system, and to avoid situations in which a malfunction or failure of such TOSHIBA products could cause loss of human life, bodily injury or damage to property.
In developing your designs, please ensure that TOSHIBA products are used within specified operating ranges as set forth in the most recent TOSHIBA products specifications. Also, please keep in mind the precautions and conditions set forth in the "Handling Guide for Semiconductor Devices," or "TOSHIBA Semiconductor Reliability Handbook" etc..
- The TOSHIBA products listed in this document are intended for usage in general electronics applications (computer, personal equipment, office equipment, measuring equipment, industrial robotics, domestic appliances, etc.). These TOSHIBA products are neither intended nor warranted for usage in equipment that requires extraordinarily high quality and/or reliability or a malfunction or failure of which may cause loss of human life or bodily injury ("Unintended Usage"). Unintended Usage include atomic energy control instruments, airplane or spaceship instruments, transportation instruments, traffic signal instruments, combustion control instruments, medical instruments, all types of safety devices, etc.. Unintended Usage of TOSHIBA products listed in this document shall be made at the customer's own risk.
- TOSHIBA products should not be embedded to the downstream products which are prohibited to be produced and sold, under any law and regulations.