

ZLLS410

10V Low leakage Schottky diode in SOD323

Summary

$V_R > 10V$; $I_F = 570mA$; I_R typ. $2\mu A$

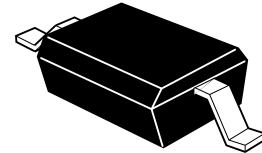

Description

This compact SOD323 packaged 10 volt Schottky diode offers users an excellent performance combination, comprising high current operation, extremely low leakage and low forward voltage ensuring suitability for low voltage applications requiring efficient operation at higher temperatures above $85^{\circ}C$ - see safe operating area charts on page 5.

Features

- Extremely low leakage
- High current capability
- Low V_F , fast switching Schottky
- SOD323 package
- Package thermally rated to $150^{\circ}C$



Applications

- Low power DC-DC conversion
- Level shifting
- Reverse blocking

Ordering information

Device	Reel size (inches)	Tape width (mm)	Quantity per reel
ZLLS410TA	7	8	3000

Device marking

41

Absolute maximum ratings

Parameter	Symbol	Limit	Unit
Continuous reverse voltage	V_R	10	V
Forward current	I_F	570	mA
Peak repetitive forward current Rectangular pulse duty cycle 50%, Pulse width = 100 μ s	I_{FPK}	1.25	A
Non repetitive forward current $t \leq 100\mu$ s $t \leq 10$ ms	I_{FSM}	17 4	A
Power dissipation at $T_{amb} = 25^\circ\text{C}$			
Continuous	P_D	330	mW
$t \leq 5$ secs		390	mW
Operating and storage temperature range	T_j, T_{stg}	-55 to 150	$^\circ\text{C}$

Thermal resistance

Parameter	Symbol	Limit	Unit
Junction to ambient ^(a)	$R_{\theta JA}$	379	$^\circ\text{C}/\text{W}$
Junction to ambient ^(b)	$R_{\theta JA}$	317	$^\circ\text{C}/\text{W}$

NOTES:

(a) For a device surface mounted on 25mm x 25mm x 1.6mm FR4 PCB with high coverage of single sided 1oz copper, in still air conditions.

(b) For a device surface mounted on FR4 PCB measured at $t < 5$ secs.

Thermal characteristics

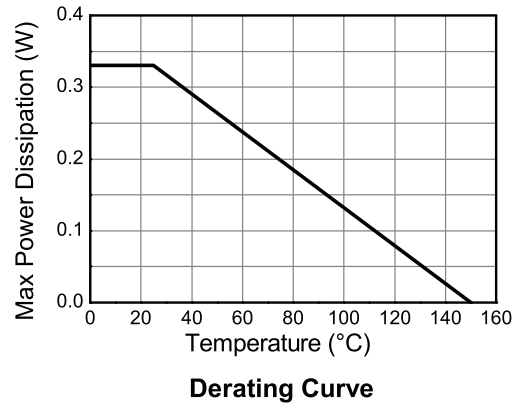
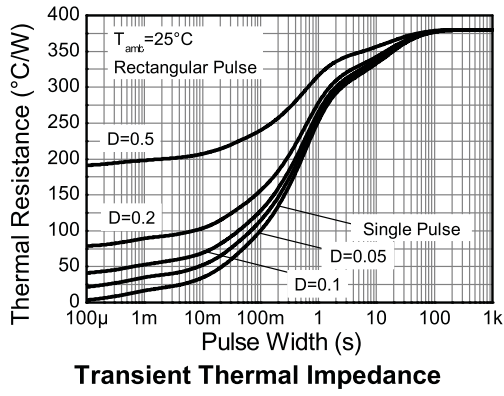

ZLLS410

Electrical characteristics (at $T_{amb} = 25^{\circ}\text{C}$ unless otherwise stated)

Parameter	Symbol	Min.	Typ.	Max.	Unit	Conditions
Reverse breakdown voltage	$BV_{(BR)R}$	10			V	$I_R = 200\mu\text{A}$
Forward voltage	V_F		250	290	mV	$I_F = 10\text{mA}^{(*)}$
			330	380	mV	$I_F = 100\text{mA}^{(*)}$
			535	580	mV	$I_F = 1\text{A}^{(*)}$
Reverse current	I_R		1.8	4	μA	$V_R = 5\text{V}$
			2.2	5	μA	$V_R = 8\text{V}$
			2.5	6	μA	$V_R = 10\text{V}$
			300	μA	$V_R = 8\text{V}, T_A = 85^{\circ}\text{C}$	
Diode capacitance	C_D		26		pF	$f = 1\text{MHz}, V_R = 10\text{V}$
Reverse recovery time	t_{rr}		3		ns	Switched from $I_F = 500\text{mA}$ to $V_R = 5.5\text{V}$ measured @ $I_R = 50\text{mA}$
Reverse recovery charge	Q_{rr}		210		pC	$di/dt = 500\text{mA/ns}$ $R_{source} = 6\Omega < R_{load} = 10\Omega$

NOTES:

(*) Measured under pulsed conditions. Pulse width $\leq 300\mu\text{s}$; duty cycle $\leq 2\%$.

Typical characteristics

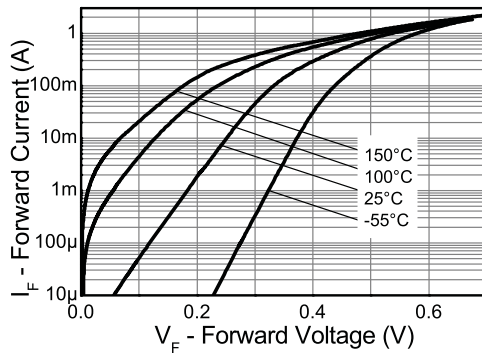

Typical Forward Characteristics

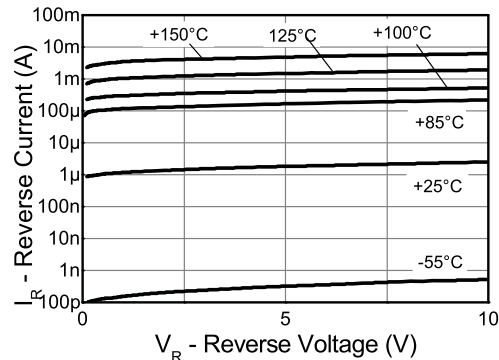

Typical Reverse Characteristics

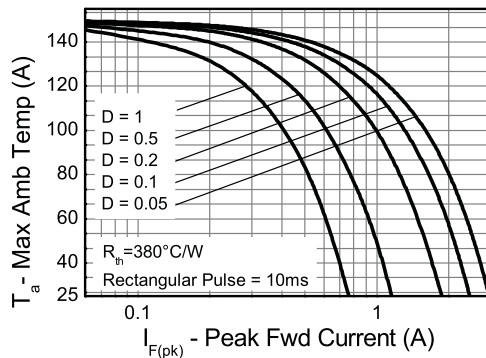

Typical Forward Safe Operating Area

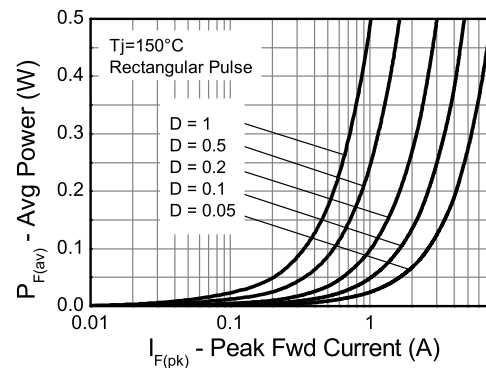

Forward Power vs Peak Current

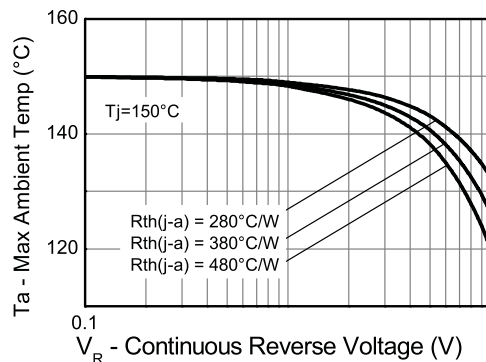

Typical Reverse Safe Operating Area

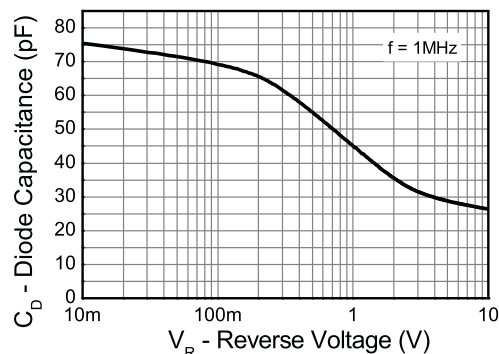

Capacitance vs Reverse Voltage

Note:

- Both forward and reverse dissipation contributes to junction temperature rise. Forward and reverse junction temperature rise are determined and added together to give total junction temperature rise.
- The safe operating curves are typical examples. Thermal resistance, pulse width and duty cycles are dependant on application.

Intentionally left blank

ZLLS410

Package outline - SOD323

Top mark

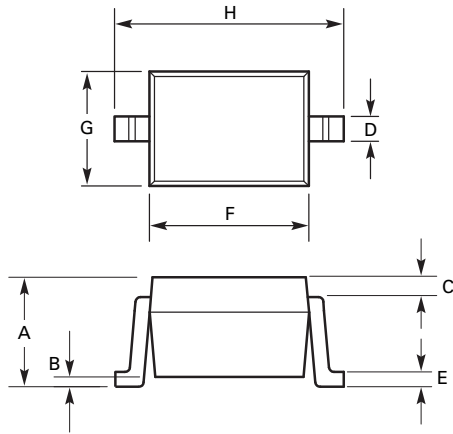

Cathode terminal is to RIGHT HAND side of part mark
Part marking text displayed is for example only

Dim.	Millimeters		Dim.	Millimeters	
	Min.	Max.		Min.	Max.
A	0.91	1.16	E	0.127	0.200
B	0.00	0.10	F	1.52	1.77
C	-	-	G	1.11	1.37
D	0.33	0.40	H	2.46	2.71

Definitions

Product change

Zetex Semiconductors reserves the right to alter, without notice, specifications, design, price or conditions of supply of any product or service. Customers are solely responsible for obtaining the latest relevant information before placing orders.

Applications disclaimer

The circuits in this design/application note are offered as design ideas. It is the responsibility of the user to ensure that the circuit is fit for the user's application and meets with the user's requirements. No representation or warranty is given and no liability whatsoever is assumed by Zetex with respect to the accuracy or use of such information, or infringement of patents or other intellectual property rights arising from such use or otherwise. Zetex does not assume any legal responsibility or will not be held legally liable (whether in contract, tort (including negligence), breach of statutory duty, restriction or otherwise) for any damages, loss of profit, business, contract, opportunity or consequential loss in the use of these circuit applications, under any circumstances.

Life support

Zetex products are specifically not authorized for use as critical components in life support devices or systems without the express written approval of the Chief Executive Officer of Zetex Semiconductors plc. As used herein:

- A. Life support devices or systems are devices or systems which:
1. are intended to implant into the body
- or
2. support or sustain life and whose failure to perform when properly used in accordance with instructions for use provided in the labeling can be reasonably expected to result in significant injury to the user.
- B. A critical component is any component in a life support device or system whose failure to perform can be reasonably expected to cause the failure of the life support device or to affect its safety or effectiveness.

Reproduction

The product specifications contained in this publication are issued to provide outline information only which (unless agreed by the company in writing) may not be used, applied or reproduced for any purpose or form part of any order or contract or be regarded as a representation relating to the products or services concerned.

Terms and Conditions

All products are sold subjects to Zetex' terms and conditions of sale, and this disclaimer (save in the event of a conflict between the two when the terms of the contract shall prevail) according to region, supplied at the time of order acknowledgement. For the latest information on technology, delivery terms and conditions and prices, please contact your nearest Zetex sales office.

Quality of product

Zetex is an ISO 9001 and TS16949 certified semiconductor manufacturer. To ensure quality of service and products we strongly advise the purchase of parts directly from Zetex Semiconductors or one of our regionally authorized distributors. For a complete listing of authorized distributors please visit: www.zetex.com/salesnetwork Zetex Semiconductors does not warrant or accept any liability whatsoever in respect of any parts purchased through unauthorized sales channels.

ESD (Electrostatic discharge)

Semiconductor devices are susceptible to damage by ESD. Suitable precautions should be taken when handling and transporting devices. The possible damage to devices depends on the circumstances of the handling and transporting, and the nature of the device. The extent of damage can vary from immediate functional or parametric malfunction to degradation of function or performance in use over time. Devices suspected of being affected should be replaced.

Green compliance

Zetex Semiconductors is committed to environmental excellence in all aspects of its operations which includes meeting or exceeding regulatory requirements with respect to the use of hazardous substances. Numerous successful programs have been implemented to reduce the use of hazardous substances and/or emissions.

All Zetex components are compliant with the RoHS directive, and through this it is supporting its customers in their compliance with WEEE and ELV directives.

Product status key:

"Preview"	Future device intended for production at some point. Samples may be available
"Active"	Product status recommended for new designs
"Last time buy (LTB)"	Device will be discontinued and last time buy period and delivery is in effect
"Not recommended for new designs"	Device is still in production to support existing designs and production
"Obsolete"	Production has been discontinued

Datasheet status key:

"Draft version"	This term denotes a very early datasheet version and contains highly provisional information, which may change in any manner without notice.
"Provisional version"	This term denotes a pre-release datasheet. It provides a clear indication of anticipated performance. However, changes to the test conditions and specifications may occur, at any time and without notice.
"Issue"	This term denotes an issued datasheet containing finalized specifications. However, changes to specifications may occur, at any time and without notice.

Zetex sales offices

Europe	Americas	Asia Pacific	Corporate Headquarters
Zetex GmbH Kustermann-park Balansstraße 59 D-81541 München Germany Telefon: (49) 89 45 49 49 0 Fax: (49) 89 45 49 49 49 europe.sales@zetex.com	Zetex Inc 700 Veterans Memorial Highway Hauppauge, NY 11788 USA Telephone: (1) 631 360 2222 Fax: (1) 631 360 8222 usa.sales@zetex.com	Zetex (Asia Ltd) 3701-04 Metroplaza Tower 1 Hing Fong Road, Kwai Fong Hong Kong Telephone: (852) 26100 611 Fax: (852) 24250 494 asia.sales@zetex.com	Zetex Semiconductors plc Zetex Technology Park, Chadderton Oldham, OL9 9LL United Kingdom Telephone: (44) 161 622 4444 Fax: (44) 161 622 4446 hq@zetex.com

© 2007 Published by Zetex Semiconductors plc