

# GI85L02

## N-CHANNEL ENHANCEMENT MODE POWER MOSFET

BV <sub>DSS</sub>	25V
R <sub>DS(ON)</sub>	6mΩ
I <sub>D</sub>	85A

### Description

The GI85L02 provide the designer with the best combination of fast switching, ruggedized device design, low on-resistance and cost-effectiveness.

The through-hole version (TO-251) is available for low-profile applications and suited for low voltage applications such as DC/DC converters.

### Features

- \*Low Gate Charge
- \*Simple Drive Requirement
- \*Fast Switching Characteristic

### Package Dimensions

**TO-251**

**Marking :**

REF.	Millimeter		REF.	Millimeter	
	Min.	Max.		Min.	Max.
A	6.40	6.80	G	0.50	0.70
B	5.20	5.50	H	2.20	2.40
C	6.80	7.20	J	0.45	0.55
D	7.20	7.80	K	0.45	0.60
E	2.30 REF.		L	0.90	1.50
F	0.60	0.90	M	5.40	5.80

### Absolute Maximum Ratings

Parameter	Symbol	Ratings	Unit
Drain-Source Voltage	V <sub>DS</sub>	25	V
Gate-Source Voltage	V <sub>GS</sub>	±20	V
Continuous Drain Current, V <sub>GS</sub> @10V	I <sub>D</sub> @T <sub>C</sub> =25°C	85	A
Continuous Drain Current, V <sub>GS</sub> @10V	I <sub>D</sub> @T <sub>C</sub> =100°C	53	A
Pulsed Drain Current <sup>1</sup>	I <sub>DM</sub>	310	A
Total Power Dissipation	P <sub>D</sub> @T <sub>C</sub> =25°C	96	W
Linear Derating Factor		0.77	W/°C
Operating Junction and Storage Temperature Range	T <sub>j</sub> , T <sub>stg</sub>	-55 ~ +150	°C

### Thermal Data

Parameter	Symbol	Value	Unit
Thermal Resistance Junction-case	R <sub>thj-c</sub>	1.3	°C/W
Thermal Resistance Junction-ambient	R <sub>thj-a</sub>	110	°C/W

## Electrical Characteristics (Tj = 25°C unless otherwise specified)

Parameter	Symbol	Min.	Typ.	Max.	Unit	Test Conditions
Drain-Source Breakdown Voltage	BV <sub>DSS</sub>	25	-	-	V	V <sub>GS</sub> =0, I <sub>D</sub> =250uA
Breakdown Voltage Temperature Coefficient	$\Delta BV_{DSS} / \Delta T_j$	-	0.037	-	V/°C	Reference to 25°C, I <sub>D</sub> =1mA
Gate Threshold Voltage	V <sub>GS(th)</sub>	1.0	-	3.0	V	V <sub>DS</sub> =V <sub>GS</sub> , I <sub>D</sub> =250uA
Forward Transconductance	g <sub>fs</sub>	-	45	-	S	V <sub>DS</sub> =10V, I <sub>D</sub> =40A
Gate-Source Leakage Current	I <sub>GSS</sub>	-	-	±100	nA	V <sub>GS</sub> = ±20V
Drain-Source Leakage Current(Tj=25°C)	I <sub>DSS</sub>	-	-	1	uA	V <sub>DS</sub> =25V, V <sub>GS</sub> =0
Drain-Source Leakage Current(Tj=150°C)		-	-	25	uA	V <sub>DS</sub> =20V, V <sub>GS</sub> =0
Static Drain-Source On-Resistance	R <sub>DS(ON)</sub>	-	-	6	mΩ	V <sub>GS</sub> =10V, I <sub>D</sub> =40A
		-	-	10		V <sub>GS</sub> =4.5V, I <sub>D</sub> =20A
Total Gate Charge <sup>2</sup>	Q <sub>g</sub>	-	49	-	nC	I <sub>D</sub> =40A V <sub>DS</sub> =20V V <sub>GS</sub> =5V
Gate-Source Charge	Q <sub>gs</sub>	-	5	-		
Gate-Drain ("Miller") Change	Q <sub>gd</sub>	-	36.5	-		
Turn-on Delay Time <sup>2</sup>	T <sub>d(on)</sub>	-	12	-	ns	V <sub>DS</sub> =15V I <sub>D</sub> =25A V <sub>GS</sub> =10V R <sub>G</sub> =3.3Ω R <sub>D</sub> =0.6Ω
Rise Time	T <sub>r</sub>	-	85	-		
Turn-off Delay Time	T <sub>d(off)</sub>	-	35	-		
Fall Time	T <sub>f</sub>	-	110	-		
Input Capacitance	C <sub>iss</sub>	-	1510	-	pF	V <sub>GS</sub> =0V V <sub>DS</sub> =25V f=1.0MHz
Output Capacitance	C <sub>oss</sub>	-	950	-		
Reverse Transfer Capacitance	C <sub>rss</sub>	-	450	-		

## Source-Drain Diode

Parameter	Symbol	Min.	Typ.	Max.	Unit	Test Conditions
Forward On Voltage <sup>2</sup>	V <sub>SD</sub>	-	-	1.26	V	I <sub>S</sub> =85A, V <sub>GS</sub> =0V, Tj=25°C
Continuous Source Current (Body Diode)	I <sub>S</sub>	-	-	85	A	V <sub>D</sub> =V <sub>G</sub> =0V, V <sub>S</sub> =1.26V
Pulse Source Current (Body Diode) <sup>1</sup>	I <sub>SM</sub>	-	-	310	A	

Notes: 1. Pulse width limited by safe operating area.

2. Pulse width ≤ 300us, duty cycle ≤ 2%.

## Characteristics Curve

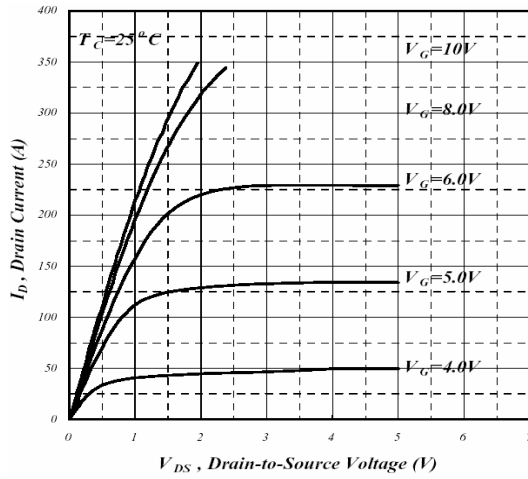

Fig 1. Typical Output Characteristics

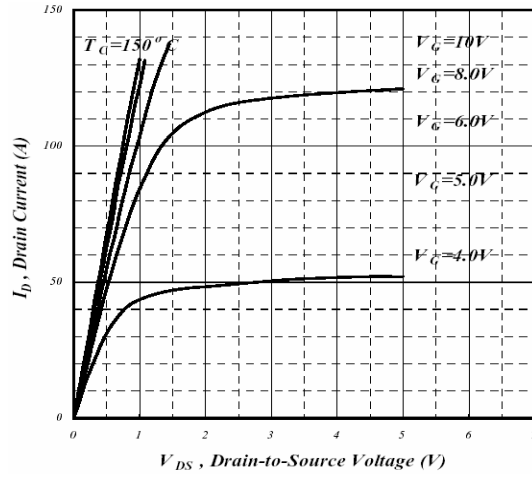

Fig 2. Typical Output Characteristics

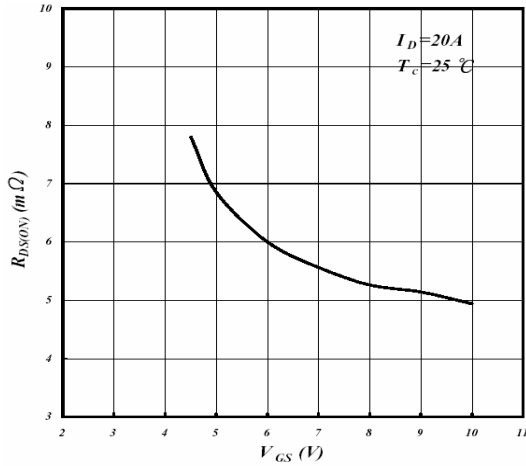

Fig 3. On-Resistance v.s. Gate Voltage

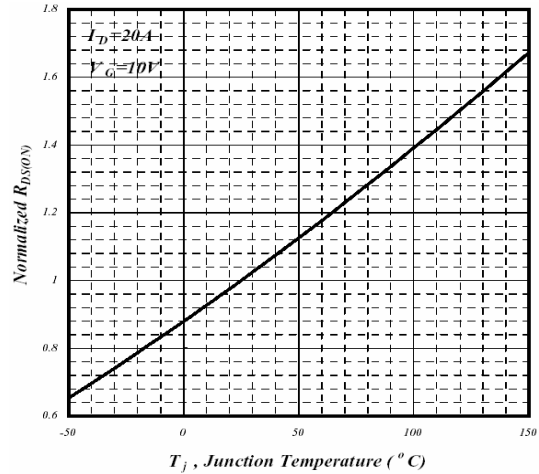

Fig 4. Normalized On-Resistance v.s. Junction Temperature

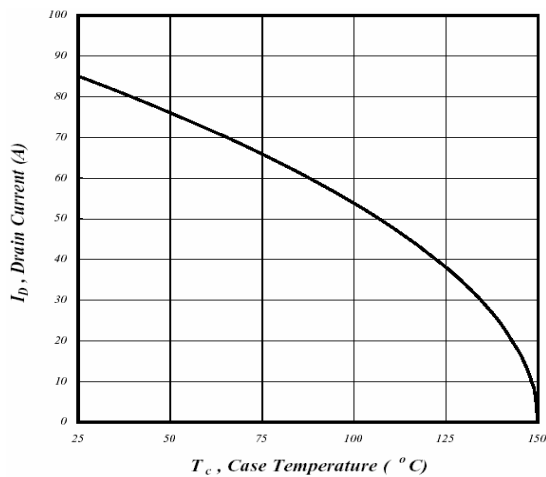

Fig 5. Maximum Drain Current v.s. Case Temperature

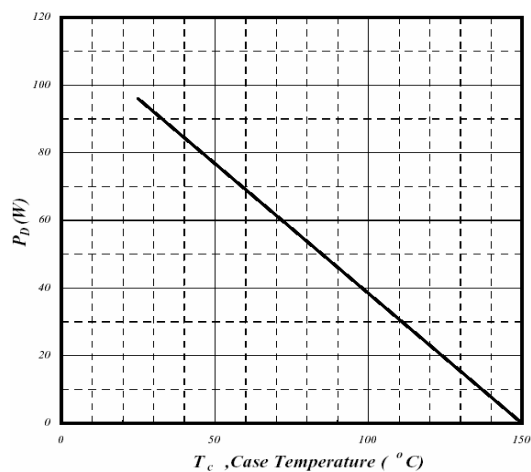
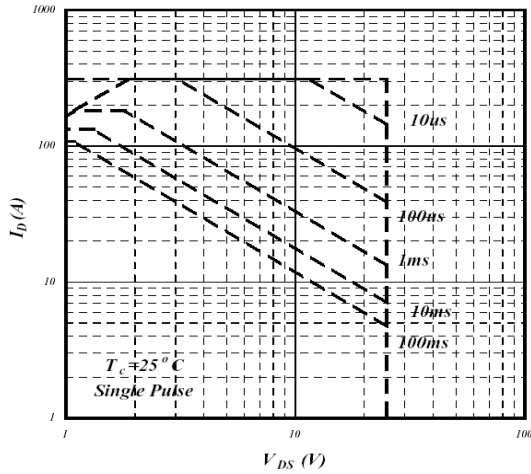
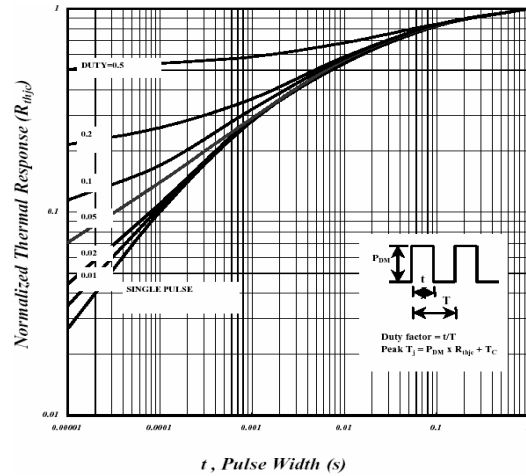

Fig 6. Type Power Dissipation



**Fig 7. Maximum Safe Operating Area**



**Fig 8. Effective Transient Thermal Impedance**

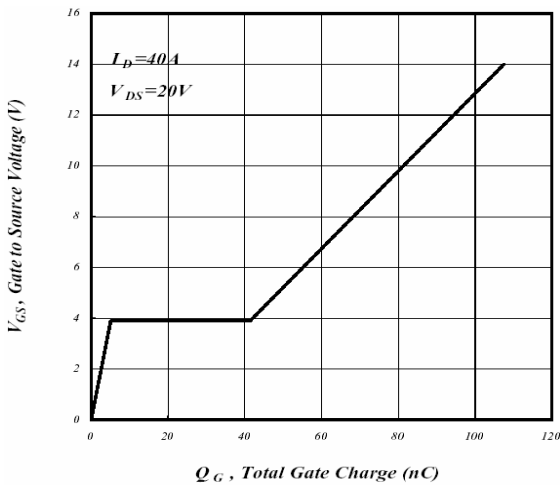

**Fig 9. Gate Charge Characteristics**

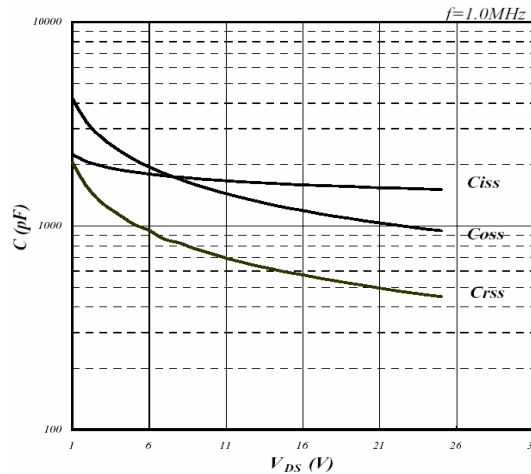

**Fig 10. Typical Capacitance Characteristics**

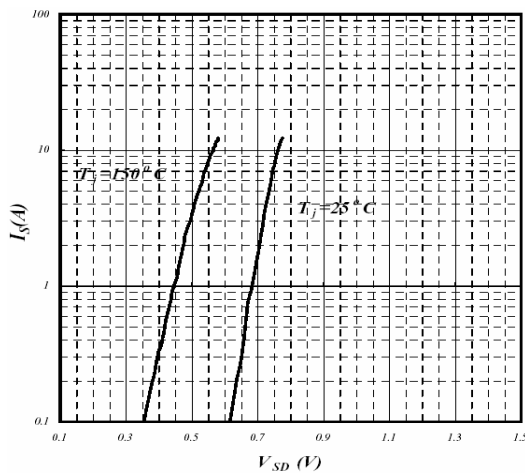

**Fig 11. Forward Characteristics of Reverse Diode**

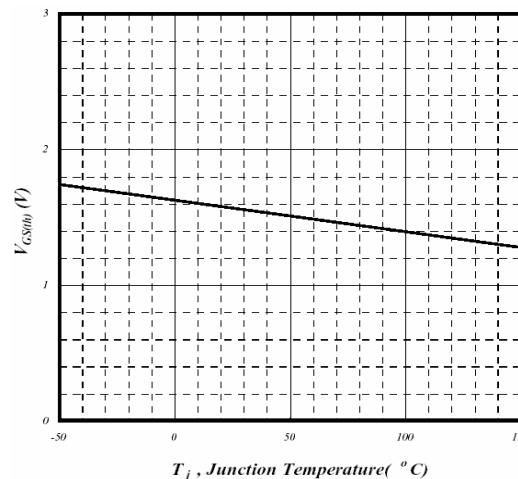

**Fig 12. Gate Threshold Voltage v.s. Junction Temperature**

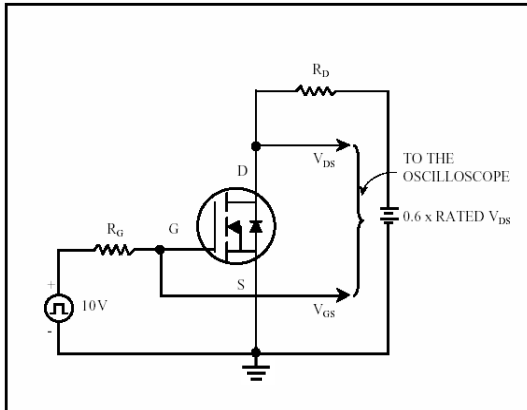

**Fig 13. Switching Time Circuit**

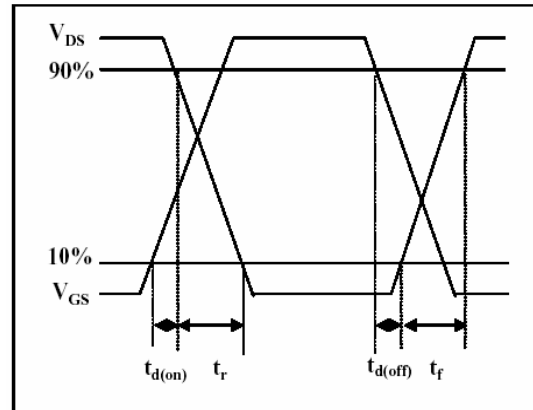

**Fig 14. Switching Time Waveform**

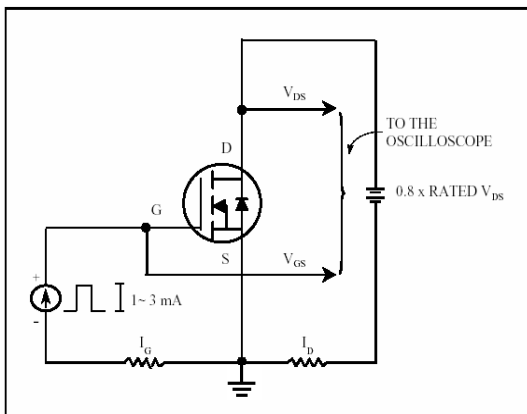

**Fig 15. Gate Charge Circuit**

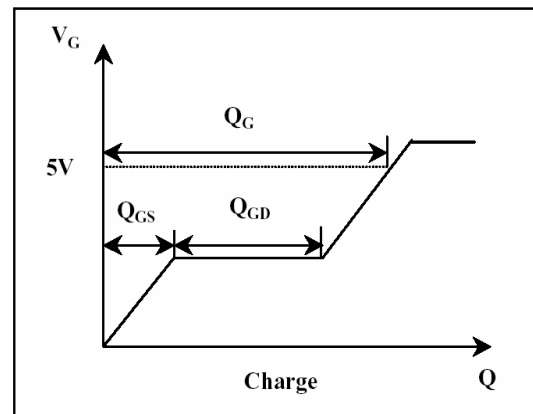

**Fig 16. Gate Charge Waveform**

**Important Notice:**

- All rights are reserved. Reproduction in whole or in part is prohibited without the prior written approval of GTM.
- GTM reserves the right to make changes to its products without notice.
- GTM semiconductor products are not warranted to be suitable for use in life-support Applications, or systems.
- GTM assumes no liability for any consequence of customer product design, infringement of patents, or application assistance.

**Head Office And Factory:**

- Taiwan: No. 17-1 Tatung Rd. Fu Kou Hsin-Chu Industrial Park, Hsin-Chu, Taiwan, R. O. C.  
TEL : 886-3-597-7061 FAX : 886-3-597-9220, 597-0785
- China: (201203) No.255, Jang-Jiang Tsai-Lueng RD. , Pu-Dung-Hsin District, Shang-Hai City, China  
TEL : 86-21-5895-7671 ~ 4 FAX : 86-21-38950165