

# CMS07

Switching Mode Power Supply Applications  
 Portable Equipment Battery Applications

- Forward voltage:  $V_{FM} = 0.45 \text{ V (max)}$
- Average forward current:  $I_F (AV) = 2.0 \text{ A}$
- Repetitive peak reverse voltage:  $V_{RRM} = 30 \text{ V}$
- Suitable for compact assembly due to small surface-mount package "M-FLAT™" (Toshiba package name)

### Absolute Maximum Ratings ( $T_a = 25^\circ\text{C}$ )

Characteristics	Symbol	Rating	Unit
Repetitive peak reverse voltage	$V_{RRM}$	30	V
Average forward current	$I_F (AV)$ (Note 1)	2.0 ( $T_a = 60^\circ\text{C}$ )	A
	$I_F (AV)$	2.0 ( $T_l = 126^\circ\text{C}$ )	
Peak one cycle surge forward current (non-repetitive)	$I_{FSM}$	40 (50 Hz)	A
Junction temperature	$T_j$	-40~150	$^\circ\text{C}$
Storage temperature	$T_{stg}$	-40~150	$^\circ\text{C}$

Note 1: Device mounted on a ceramic board (board size: 50 mm × 50 mm, soldering land: 2 mm × 2 mm)

Note 2: Using continuously under heavy loads (e.g. the application of high temperature/current/voltage and the significant change in temperature, etc.) may cause this product to decrease in the reliability significantly even if the operating conditions (i.e. operating temperature/current/voltage, etc.) are within the absolute maximum ratings.

Please design the appropriate reliability upon reviewing the Toshiba Semiconductor Reliability Handbook ("Handling Precautions"/Derating Concept and Methods) and individual reliability data (i.e. reliability test report and estimated failure rate, etc).

### Electrical Characteristics ( $T_a = 25^\circ\text{C}$ )

Characteristics	Symbol	Test Condition	Min	Typ.	Max	Unit
Peak forward voltage	$V_{FM} (1)$	$I_{FM} = 0.5 \text{ A}$	—	0.35	—	V
	$V_{FM} (2)$	$I_{FM} = 1.0 \text{ A}$	—	0.38	—	
	$V_{FM} (3)$	$I_{FM} = 2.0 \text{ A}$	—	0.41	0.45	
Repetitive peak reverse current	$I_{RRM}$	$V_{RRM} = 5 \text{ V}$	—	3.0	—	$\mu\text{A}$
	$I_{RRM}$	$V_{RRM} = 30 \text{ V}$	—	30.0	500	
Junction capacitance	$C_j$	$V_R = 10 \text{ V}, f = 1.0 \text{ MHz}$	—	130	—	pF
Thermal resistance	$R_{th} (j-a)$	Device mounted on a ceramic board (soldering land: 2 mm × 2 mm)	—	—	60	$^\circ\text{C/W}$
		Device mounted on a glass-epoxy board (soldering land: 6 mm × 6 mm)	—	—	135	
Thermal resistance	$R_{th} (j-t)$	—	—	—	16	$^\circ\text{C/W}$

Unit: mm

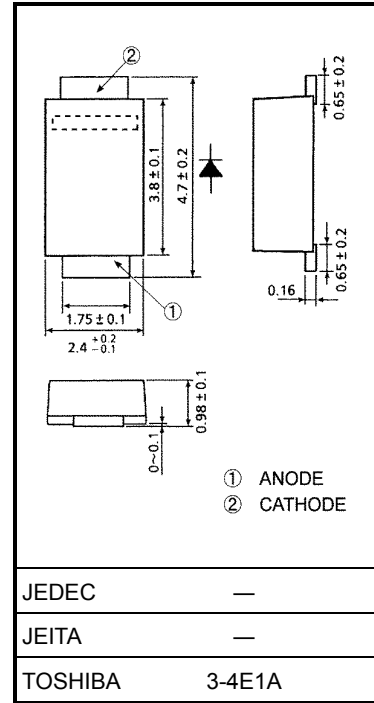

Weight: 0.023 g (typ.)

## Marking

Abbreviation Code	Part No.
S7	CMS07

## Standard Soldering Pad

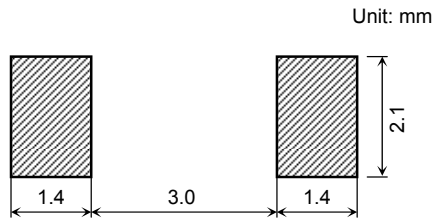

## Handling Precaution

Schottky barrier diodes have reverse current characteristics compared to other diodes. There is a possibility SBD may cause thermal runaway when it is used under high temperature or high voltage. Please take forward and reverse loss into consideration during design.

The absolute maximum ratings denote the absolute maximum ratings, which are rated values and must not be exceeded during operation, even for an instant. The following are the general derating methods that we recommend when you design a circuit with a device.

- V<sub>RRM</sub>:** Use this rating with reference to the above. V<sub>RRM</sub> has a temperature coefficient of 0.1%/°C. Take this temperature coefficient into account designing a device at low temperature.
- I<sub>F(AV)</sub>:** We recommend that the worst case current be no greater than 80% of the absolute maximum rating of I<sub>F(AV)</sub> and T<sub>j</sub> be below 120°C. When using this device, take the margin into consideration by using an allowable T<sub>max</sub>-I<sub>F(AV)</sub> curve.
- I<sub>FSM</sub>:** This rating specifies the non-repetitive peak current. This is only applied for an abnormal operation, which seldom occurs during the lifespan of the device.
- T<sub>j</sub>:** Derate this rating when using a device in order to ensure high reliability. We recommend that the device be used at a T<sub>j</sub> of below 120°C.

Thermal resistance between junction and ambient fluctuates depending on the device's mounting condition. When using a device, design a circuit board and a soldering land size to match the appropriate thermal resistance value.

Please refer to the Rectifiers databook for further information.

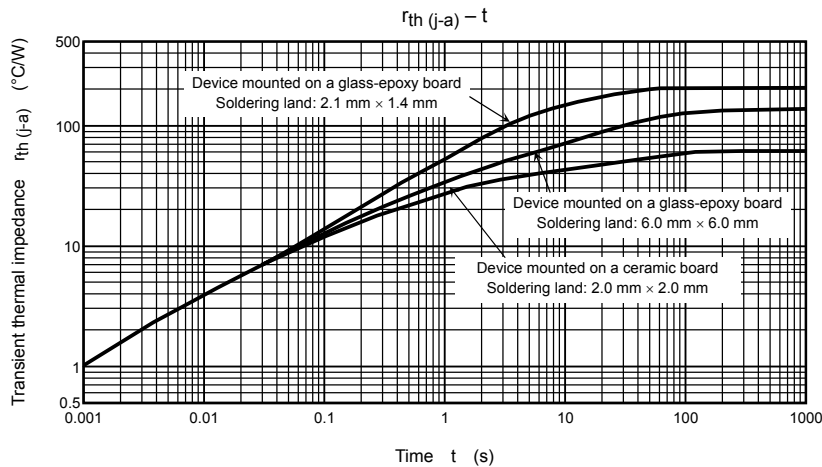
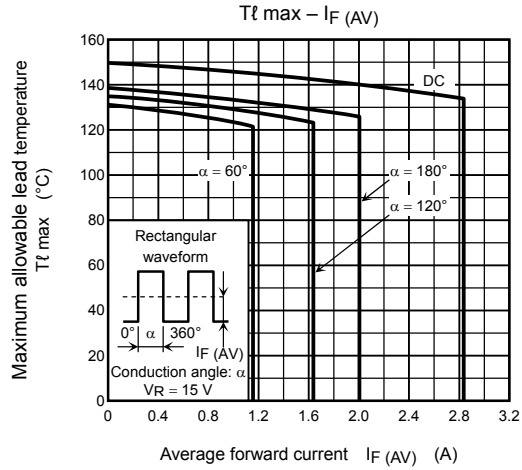
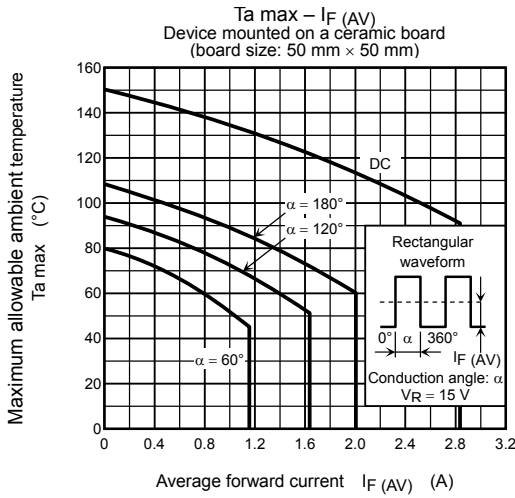
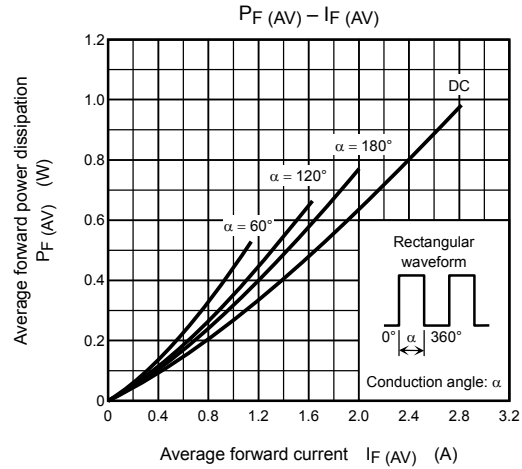
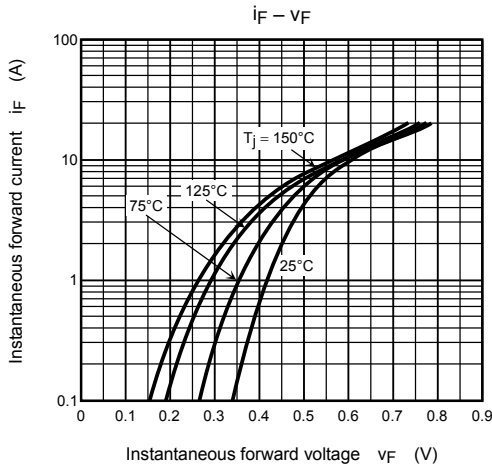

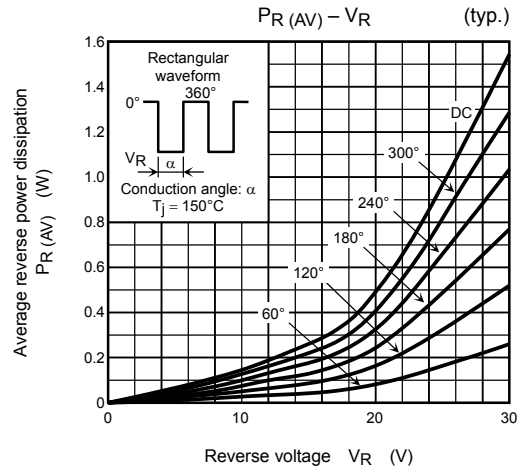
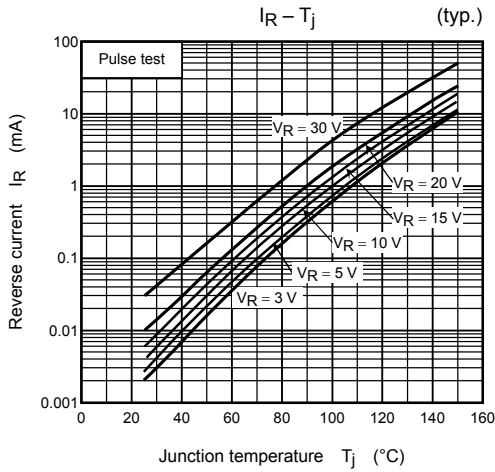
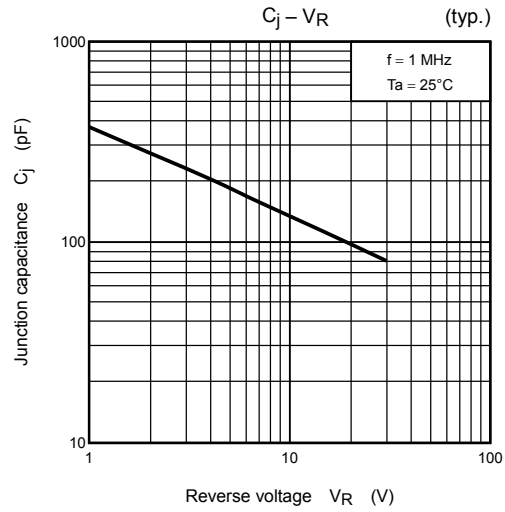
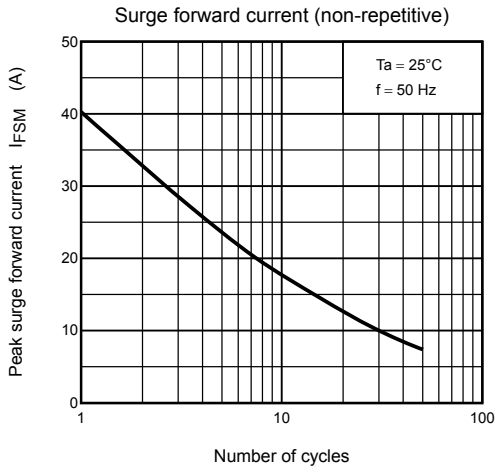

**RESTRICTIONS ON PRODUCT USE**

20070701-EN

- The information contained herein is subject to change without notice.
- TOSHIBA is continually working to improve the quality and reliability of its products. Nevertheless, semiconductor devices in general can malfunction or fail due to their inherent electrical sensitivity and vulnerability to physical stress. It is the responsibility of the buyer, when utilizing TOSHIBA products, to comply with the standards of safety in making a safe design for the entire system, and to avoid situations in which a malfunction or failure of such TOSHIBA products could cause loss of human life, bodily injury or damage to property.  
In developing your designs, please ensure that TOSHIBA products are used within specified operating ranges as set forth in the most recent TOSHIBA products specifications. Also, please keep in mind the precautions and conditions set forth in the "Handling Guide for Semiconductor Devices," or "TOSHIBA Semiconductor Reliability Handbook" etc.
- The TOSHIBA products listed in this document are intended for usage in general electronics applications (computer, personal equipment, office equipment, measuring equipment, industrial robotics, domestic appliances, etc.). These TOSHIBA products are neither intended nor warranted for usage in equipment that requires extraordinarily high quality and/or reliability or a malfunction or failure of which may cause loss of human life or bodily injury ("Unintended Usage"). Unintended Usage include atomic energy control instruments, airplane or spaceship instruments, transportation instruments, traffic signal instruments, combustion control instruments, medical instruments, all types of safety devices, etc.. Unintended Usage of TOSHIBA products listed in this document shall be made at the customer's own risk.
- The products described in this document shall not be used or embedded to any downstream products of which manufacture, use and/or sale are prohibited under any applicable laws and regulations.
- The information contained herein is presented only as a guide for the applications of our products. No responsibility is assumed by TOSHIBA for any infringements of patents or other rights of the third parties which may result from its use. No license is granted by implication or otherwise under any patents or other rights of TOSHIBA or the third parties.
- Please contact your sales representative for product-by-product details in this document regarding RoHS compatibility. Please use these products in this document in compliance with all applicable laws and regulations that regulate the inclusion or use of controlled substances. Toshiba assumes no liability for damage or losses occurring as a result of noncompliance with applicable laws and regulations.