

Features

- Lead free as standard
- RoHS compliant*
- Leadless
- Low stored charge

Applications

- Cellular phones
- PDAs
- Desktop PCs and notebooks
- Digital cameras
- MP3 players

CD0603/1005 Schottky Barrier Chip Diode Series

General Information

The markets of portable communications, computing and video equipment are challenging the semiconductor industry to develop increasingly smaller electronic components.

Bourns offers small-signal high-speed Schottky Barrier Diodes for switching and rectification applications, in compact chip package 0603 and 1005 size format, which offer PCB real estate savings and are considerably smaller than most competitive parts. The Schottky Barrier Diodes offer a forward current of 30 mA, 100 mA or 200 mA, a reverse voltage of 30 V and 40 V and also have a low forward voltage option. The diodes are lead free with Cu/Ni/Au plated terminations and are compatible with lead free manufacturing processes, conforming to many industry and government regulations on lead free components.

Bourns® Chip Diodes conform to JEDEC standards, easy to handle on standard pick and place equipment and their flat configuration makes roll away much more difficult.

Electrical Characteristics (@ T_A = 25 °C Unless Otherwise Noted)

Parameter	Symbol	CDxxx-B00340	CDxxx-B0130L	CDxxx-B0140L	CDxxx-B0140R	CDxxx-B0230	CDxxx-B0240	Unit
Forward Voltage (Max.)	V _F	0.37 (I _f = 1 mA)	0.44 (I _f = 0.1 A)	0.55 (I _f = 0.1 A)	0.45 (I _f = 0.01 A)	0.50 (I _f = 0.2 A)	0.55 (I _f = 0.2 A)	V
Capacitance Between Terminals (Max.) (f = 1 MHz)	C _T	1.5 (V _r = 1 V)	9 (V _r = 10 V)	9 (V _r = 10 V)	9 (V _r = 10 V)	12 (V _r = 10 V)	12 (V _r = 10 V)	pF
Reverse Current (Max.)	I _R	1 (V _r = 40 V)	30 (V _r = 30 V)	30 (V _r = 10 V)	1 (V _r = 10 V)	30 (V _r = 30 V)	10 (V _r = 30 V)	μA

How To Order

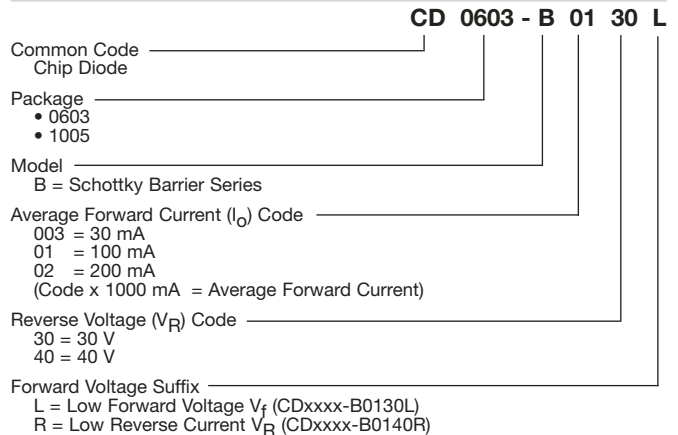

*RoHS Directive 2002/95/EC Jan 27 2003 including Annex
Specifications are subject to change without notice.
Customers should verify actual device performance in their specific applications.

CD0603/1005 Schottky Barrier Chip Diode Series

BOURNS®

Absolute Ratings (@ T_A = 25 °C Unless Otherwise Noted)

Parameter	Symbol	CD0603- B00340	CD0603- B0130L	CD0603- B0140L	CD0603- B0140R	CD0603- B0230	CD0603- B0240	Unit
Repetitive Peak Reverse Voltage	V _{RRM}	45	35	45	45	35	45	V
Reverse Voltage	V _R	40	30	40	40	30	40	V
Average Forward Current	I _o	30	100	100	100	200	200	mA
Forward Current, Surge Peak	I _{surge}	500*	1000*	1000*	1000*	2000*	2000*	mA
Power Dissipation	PD				150			mW
Storage Temperature	T _{STG}				-40 to +125			°C
Junction Temperature	T _J				-40 to +125			°C

Parameter	Symbol	CD1005- B00340	CD1005- B0130L	CD1005- B0140L	CD1005- B0140R	CD1005- B0230	CD1005- B0240	Unit
Repetitive Peak Reverse Voltage	V _{RRM}	45	35	45	45	35	45	V
Reverse Voltage	V _R	40	30	40	40	30	40	V
Average Forward Current	I _o	30	100	100	100	200	200	mA
Forward Current, Surge Peak	I _{surge}	500*	1000*	1000*	1000*	3000*	3000*	mA
Power Dissipation	PD	200	250	250	250	250	250	mW
Storage Temperature	T _{STG}				-40 to +125			°C
Junction Temperature	T _J				-40 to +125			°C

* Condition: 8.3 ms single half sine-wave superimposed on rate load (JEDEC method).

CD0603/1005 Schottky Barrier Chip Diode Series

BOURNS®

Product Dimensions

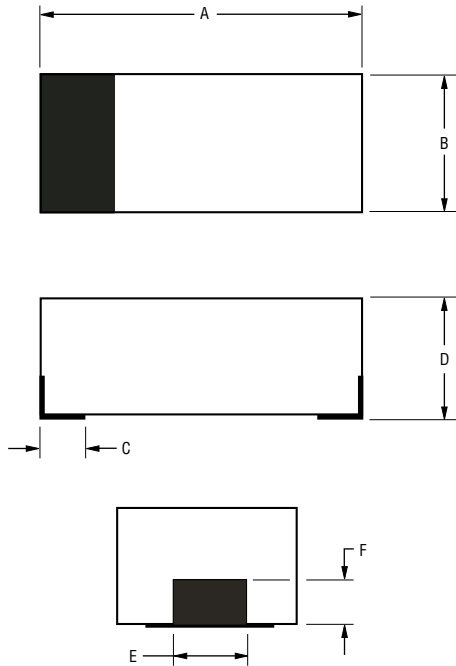

Dimension	0603	1005
A	$\frac{1.60 - 1.80}{(0.063 - 0.071)}$	$\frac{2.40 - 2.60}{(0.095 - 0.102)}$
B	$\frac{0.80 - 1.00}{(0.031 - 0.039)}$	$\frac{1.10 - 1.30}{(0.043 - 0.051)}$
C	$\frac{0.25}{(0.010)}$ Typ.	$\frac{0.35}{(0.014)}$ Typ.
D	$\frac{0.70 - 0.85}{(0.027 - 0.033)}$	$\frac{0.70 - 0.90}{(0.027 - 0.035)}$
E	$\frac{0.35}{(0.014)}$ Typ.	$\frac{0.35}{(0.014)}$ Typ.
F	$\frac{0.30}{(0.012)}$ Typ.	$\frac{0.30}{(0.012)}$ Typ.

DIMENSIONS: $\frac{\text{MM}}{\text{(INCHES)}}$

Recommended Pad Layout

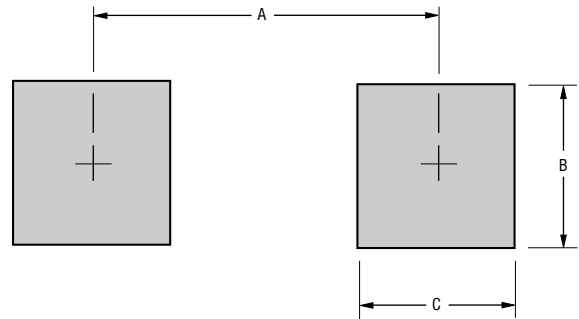

Dimension	0603	1005
A (Max.)	$\frac{1.70}{(0.067)}$	$\frac{2.10}{(0.082)}$
B (Min.)	$\frac{0.80}{(0.031)}$	$\frac{1.20}{(0.047)}$
C (Min.)	$\frac{0.60}{(0.024)}$	$\frac{1.20}{(0.047)}$

DIMENSIONS: $\frac{\text{MM}}{\text{(INCHES)}}$

Physical Specifications

Case0603(1608) / 1005(2512) Molded plastic
 TerminalsSolder plated, solderable per MIL-STD-750,
 Method 2026
 PolarityIndicated by cathode band
 Mounting PositionAny
 Weight0.000159 ounces / 0.0045 grams

Typical Part Marking

CDxxxx-B00340B2
 CDxxxx-B0130LB3
 CDxxxx-B0140LB7
 CDxxxx-B0140RB8
 CDxxxx-B0230B5
 CDxxxx-B0240B9

CD0603/1005 Schottky Barrier Chip Diode Series

BOURNS®

Rating and Characteristic Curves: CDxxx-B00340

Forward Characteristics

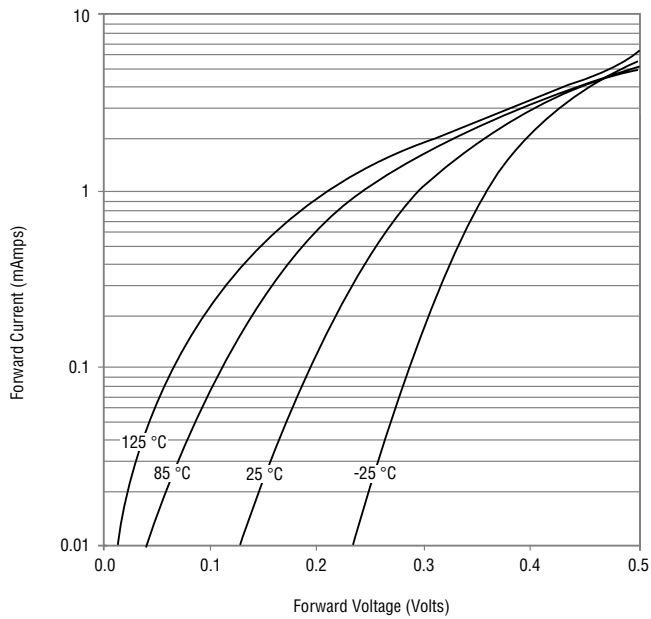

Reverse Characteristics

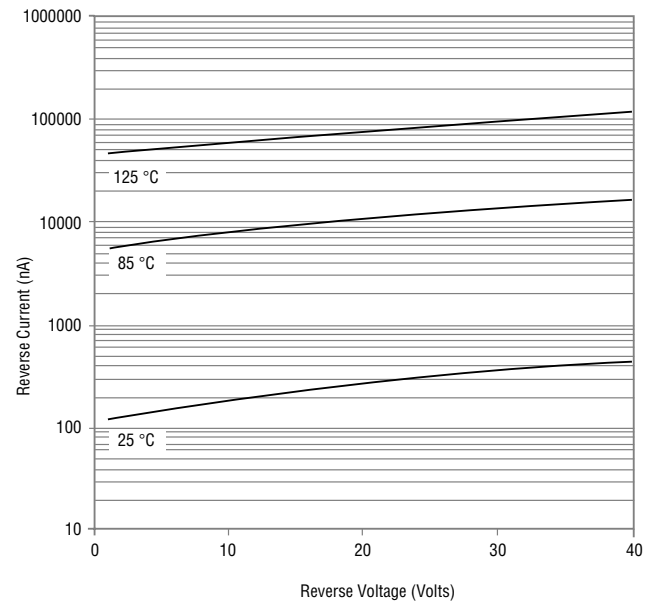

Derating Curve

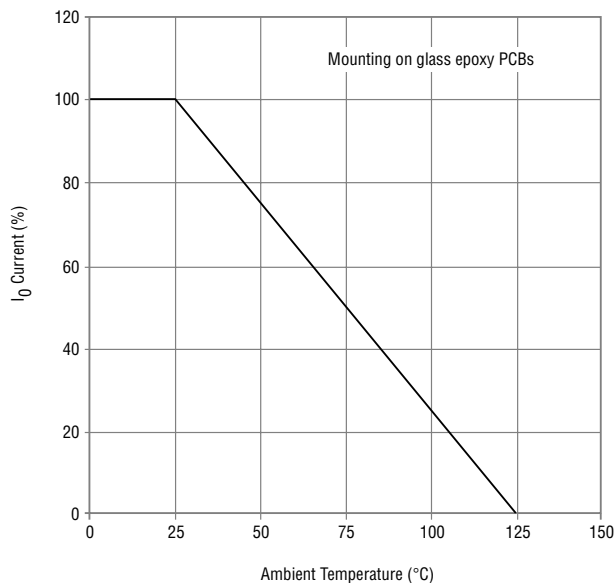

Capacitance Between Terminals

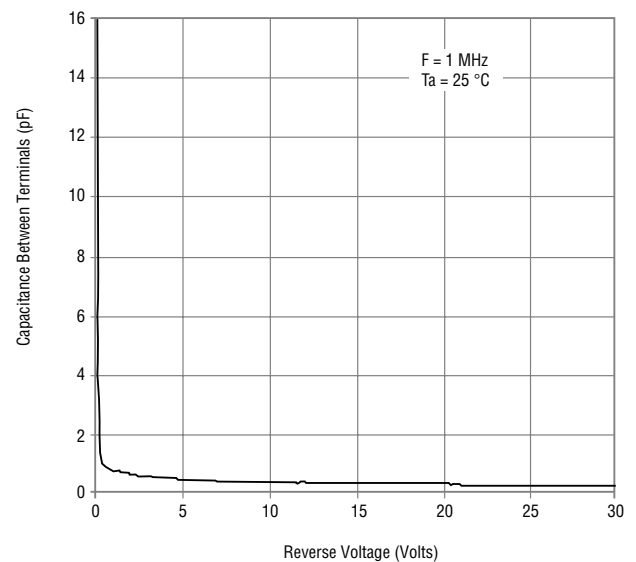

Specifications are subject to change without notice. Customers should verify actual device performance in their specific applications.

CD0603/1005 Schottky Barrier Chip Diode Series

BOURNS®

Rating and Characteristic Curves: CDxxx-B0130L

Forward Characteristics

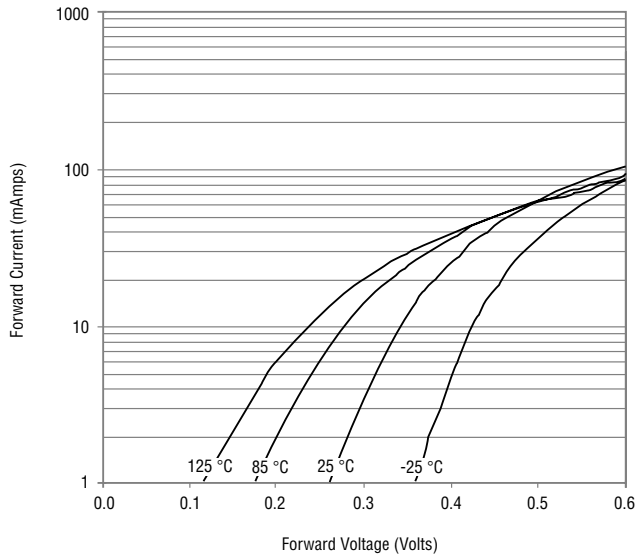

Reverse Characteristics

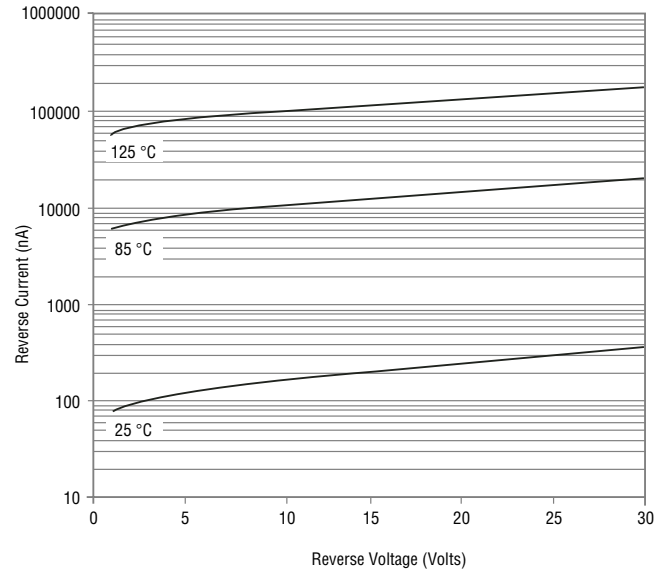

Derating Curve

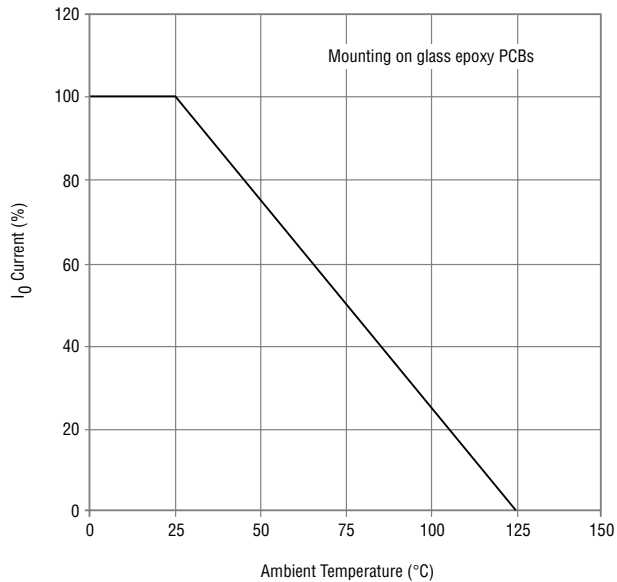

Capacitance Between Terminals

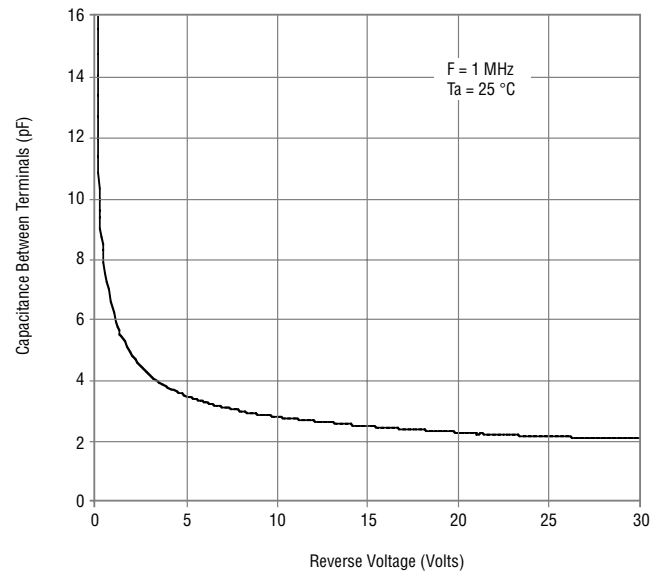

Specifications are subject to change without notice.
Customers should verify actual device performance in their specific applications.

CD0603/1005 Schottky Barrier Chip Diode Series

BOURNS®

Rating and Characteristic Curves: CDxxxx-B0140L

Forward Characteristics

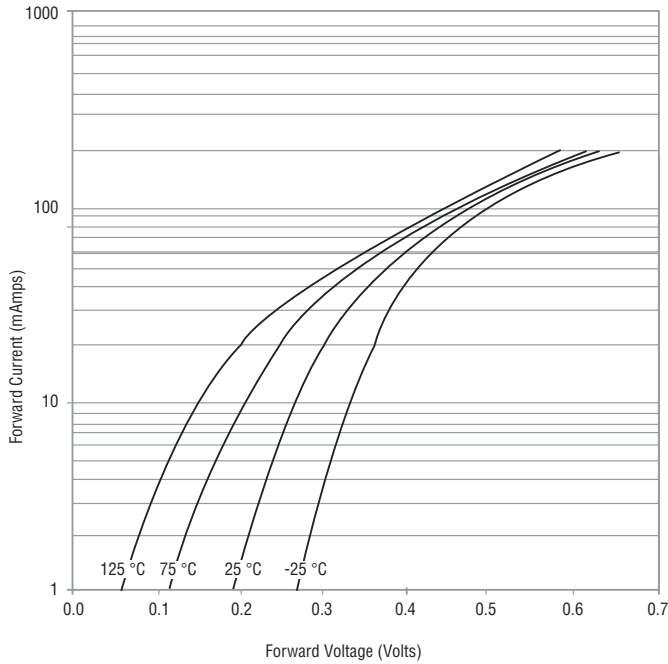

Reverse Characteristics

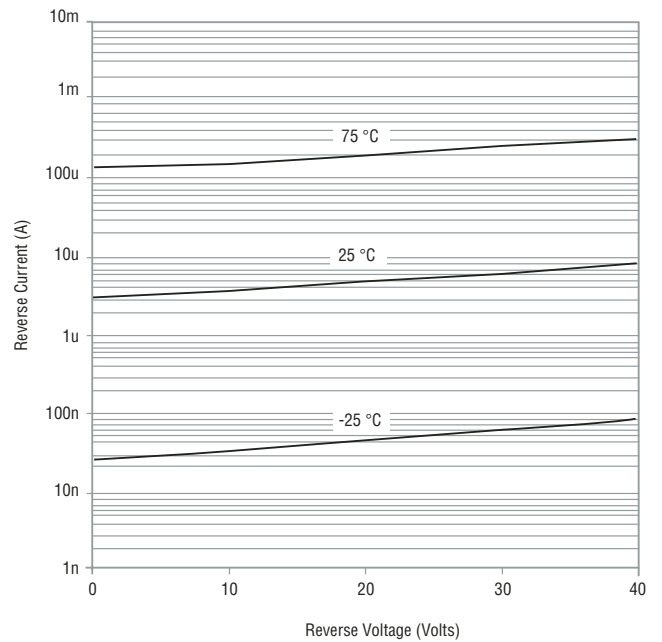

Derating Curve

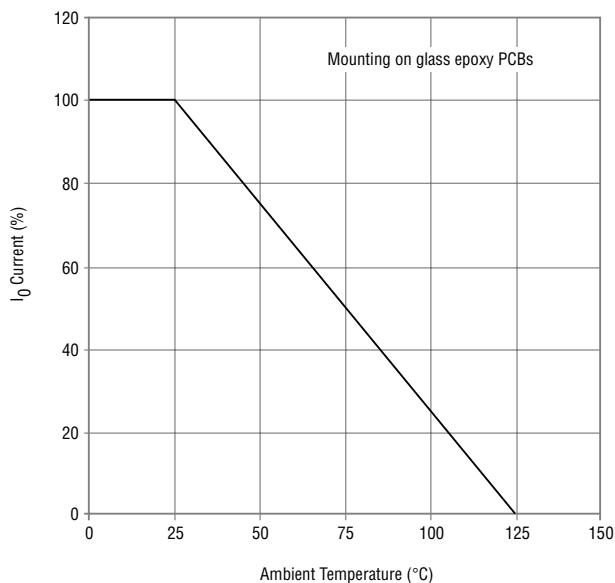

Capacitance Between Terminals

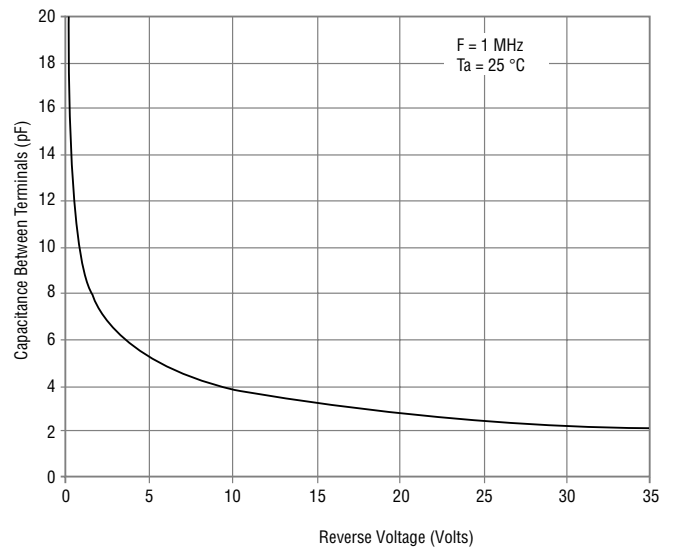

Specifications are subject to change without notice. Customers should verify actual device performance in their specific applications.

CD0603/1005 Schottky Barrier Chip Diode Series

BOURNS®

Rating and Characteristic Curves: CDxxx-B0140R

Forward Characteristics

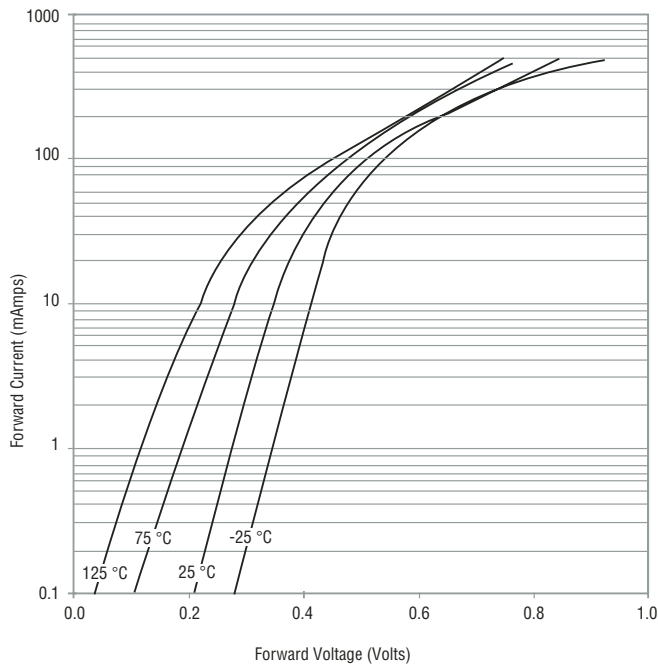

Reverse Characteristics

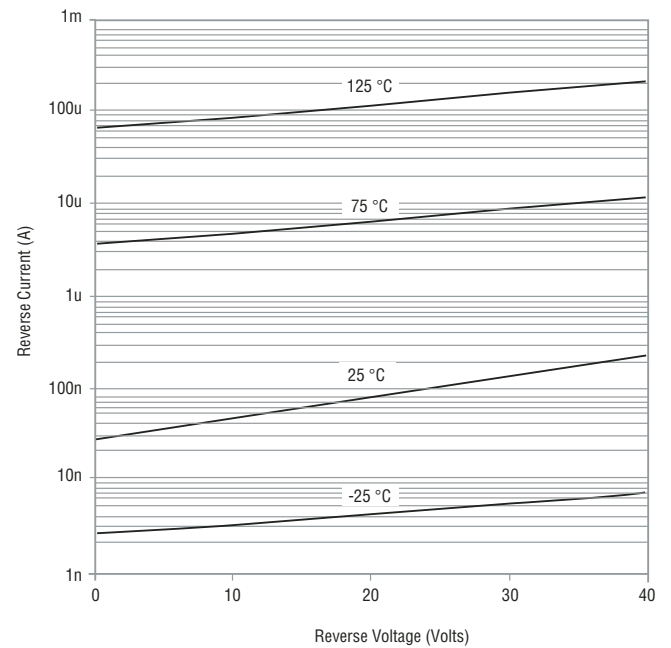

Derating Curve

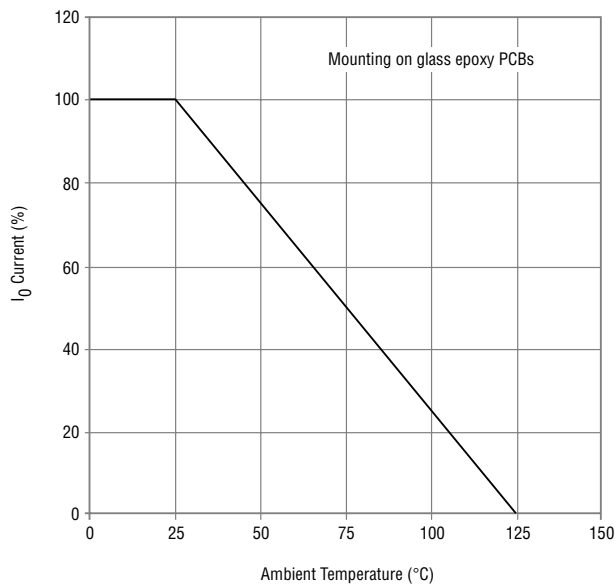

Capacitance Between Terminals

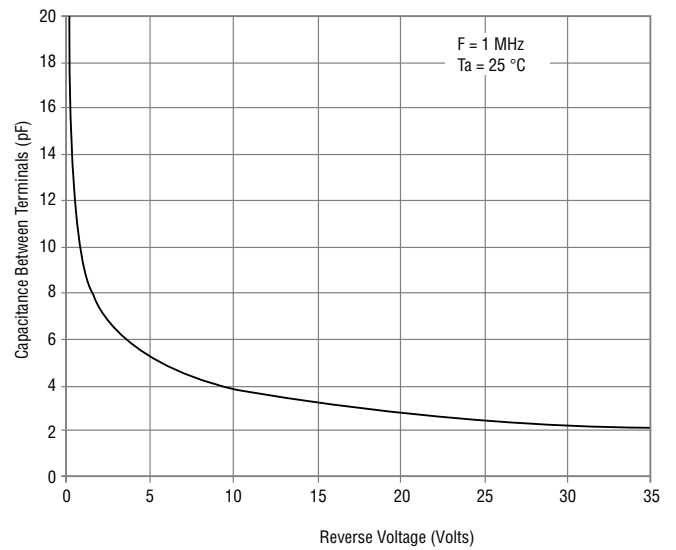

Specifications are subject to change without notice.
Customers should verify actual device performance in their specific applications.

CD0603/1005 Schottky Barrier Chip Diode Series

BOURNS®

Rating and Characteristic Curves: CDxxxx-B0230

Forward Characteristics

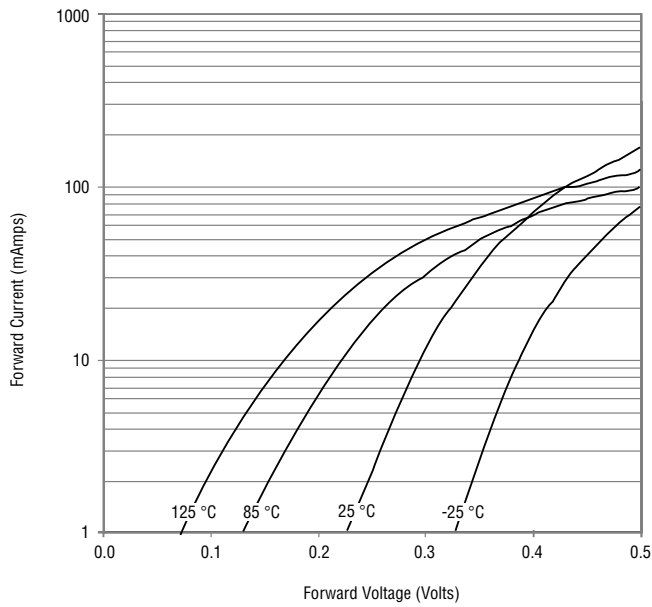

Reverse Characteristics

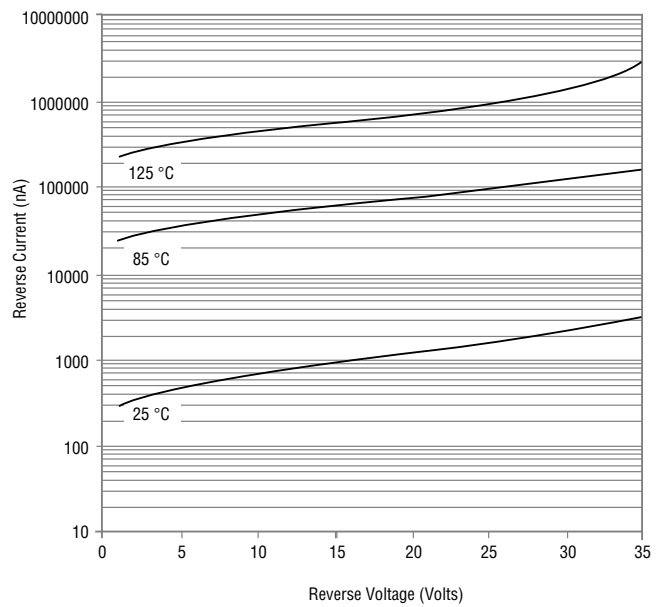

Derating Curve

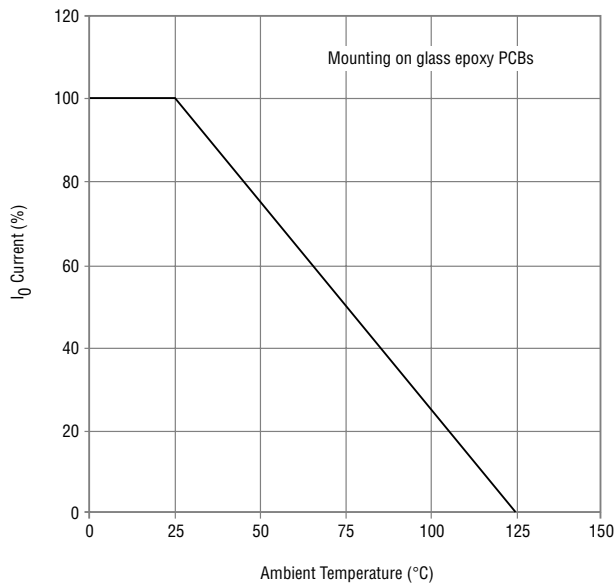

Capacitance Between Terminals

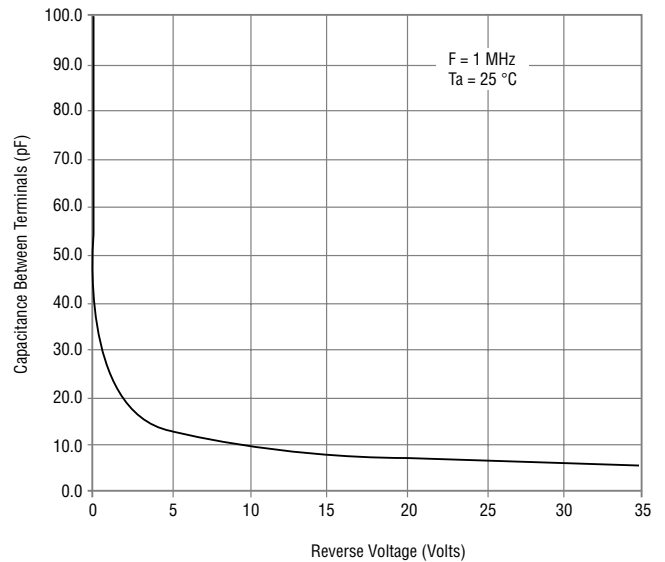

Specifications are subject to change without notice. Customers should verify actual device performance in their specific applications.

CD0603/1005 Schottky Barrier Chip Diode Series

BOURNS®

Rating and Characteristic Curves: CDxxx-B0240

Forward Characteristics

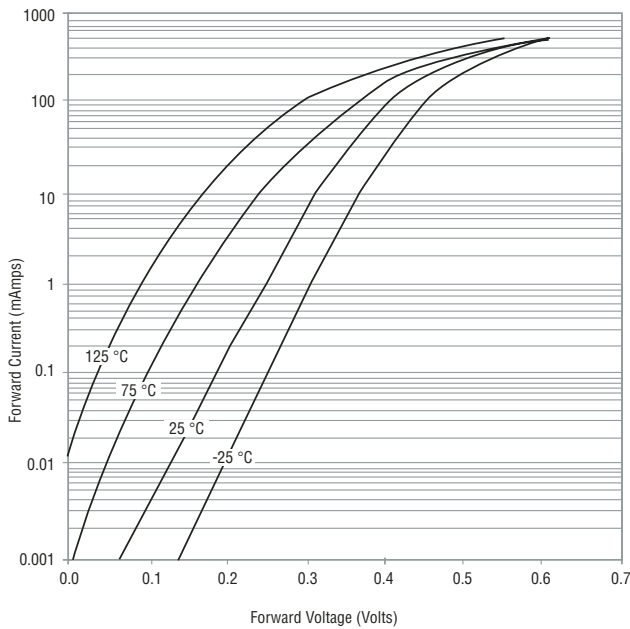

Reverse Characteristics

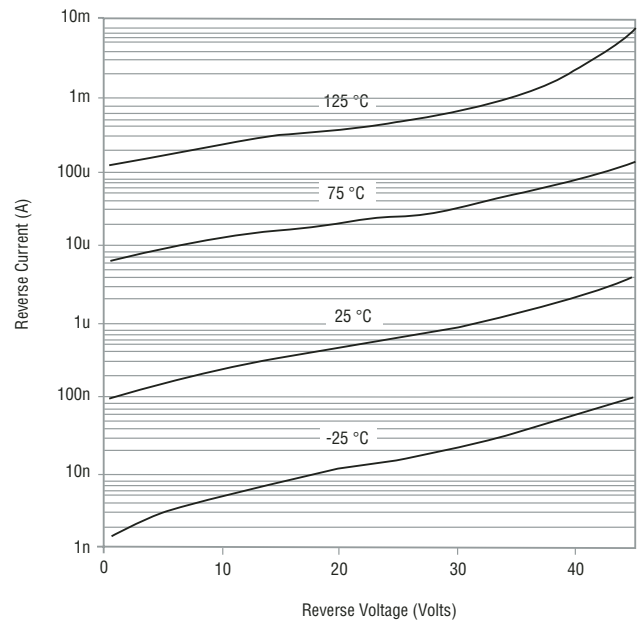

Derating Curve

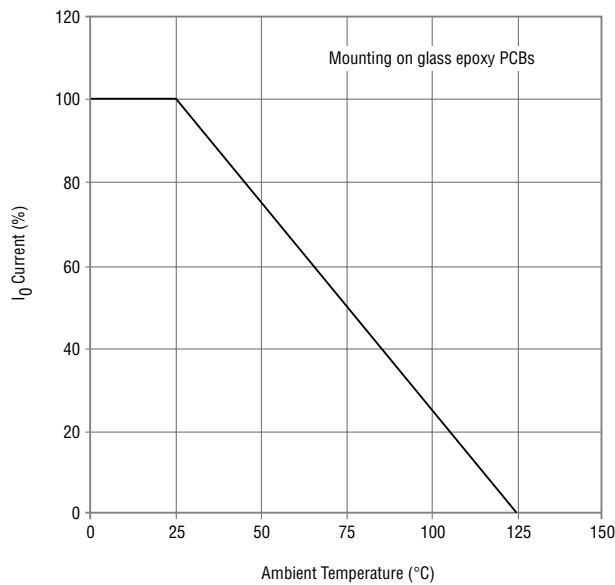

Capacitance Between Terminals

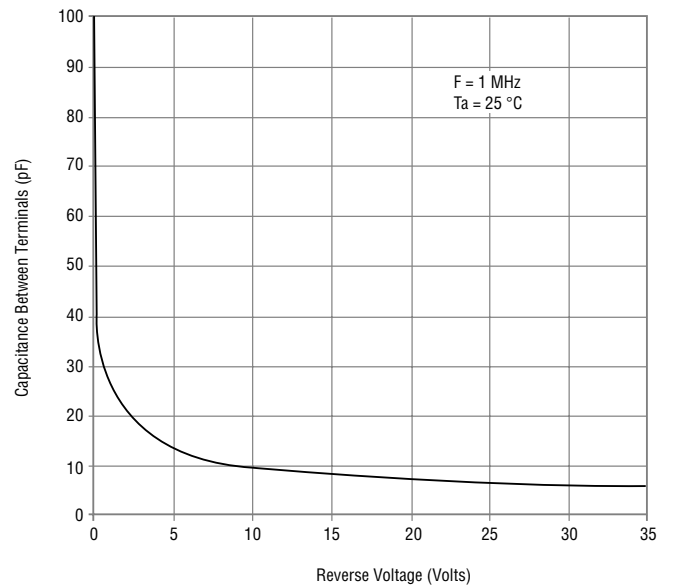

Specifications are subject to change without notice.
Customers should verify actual device performance in their specific applications.

CD0603/1005 Schottky Barrier Chip Diode Series

BOURNS®

Packaging Information

The product will be dispensed in Tape and Reel format (see diagram below).

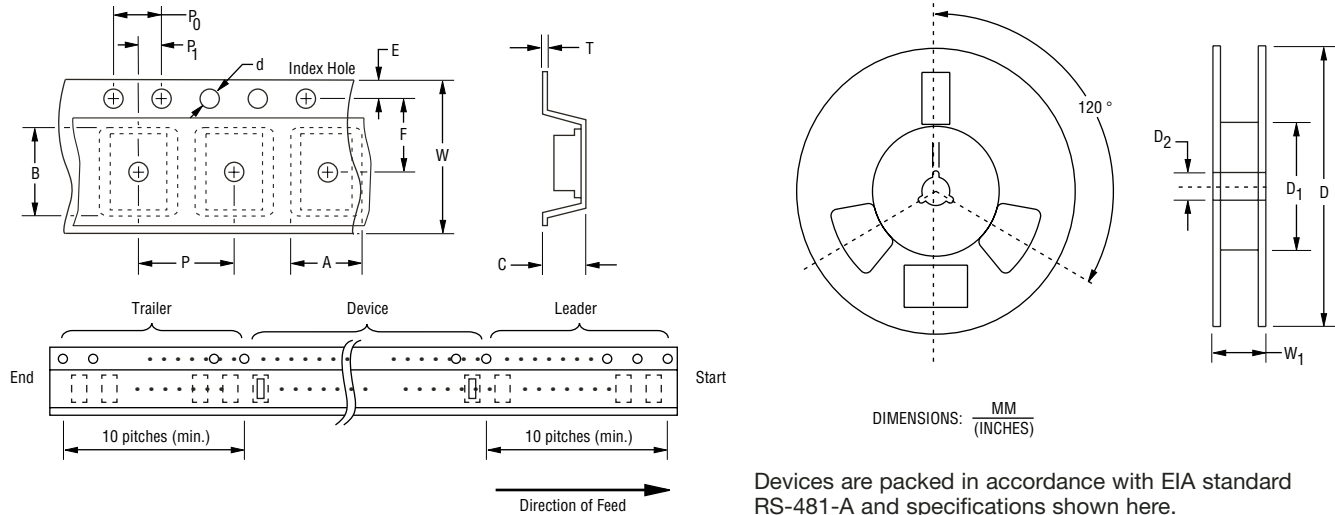

Item	Symbol	0603	1005
Carrier Width	A	$\frac{1.00 \pm 0.10}{(0.039 - 0.004)}$	$\frac{1.55 \pm 0.10}{(0.061 - 0.004)}$
Carrier Length	B	$\frac{1.85 \pm 0.10}{(0.073 - 0.004)}$	$\frac{2.65 \pm 0.10}{(0.104 - 0.004)}$
Carrier Depth	C	$\frac{1.00 \pm 0.10}{(0.039 - 0.004)}$	$\frac{1.05 \pm 0.10}{(0.041 - 0.004)}$
Sprocket Hole	d	$\frac{1.55 \pm 0.05}{(0.061 - 0.002)}$	$\frac{1.55 \pm 0.10}{(0.061 - 0.004)}$
Reel Outside Diameter	D	$\frac{178}{(7.008)}$	$\frac{178}{(7.008)}$
Reel Inner Diameter	D ₁	$\frac{60.0}{(2.362)}$ MIN.	$\frac{60.0}{(2.362)}$ MIN.
Feed Hole Diameter	D ₂	$\frac{13.0 \pm 0.20}{(0.512 - 0.008)}$	$\frac{13.0 \pm 0.20}{(0.512 - 0.008)}$
Sprocket Hole Position	E	$\frac{1.75 \pm 0.10}{(0.069 - 0.004)}$	$\frac{1.75 \pm 0.10}{(0.069 - 0.004)}$
Punch Hole Position	F	$\frac{3.50 \pm 0.05}{(0.138 - 0.002)}$	$\frac{3.50 \pm 0.05}{(0.138 - 0.002)}$
Punch Hole Pitch	P	$\frac{4.00 \pm 0.10}{(0.157 - 0.004)}$	$\frac{4.00 \pm 0.10}{(0.157 - 0.004)}$
Sprocket Hole Pitch	P ₀	$\frac{4.00 \pm 0.10}{(0.157 - 0.004)}$	$\frac{4.00 \pm 0.10}{(0.157 - 0.004)}$
Embossment Center	P ₁	$\frac{2.00 \pm 0.05}{(0.079 - 0.002)}$	$\frac{2.00 \pm 0.05}{(0.079 - 0.002)}$
Overall Tape Thickness	T	$\frac{0.20 \pm 0.05}{(0.008 - 0.002)}$	$\frac{0.25 \pm 0.05}{(0.010 - 0.002)}$
Tape Width	W	$\frac{8.00 \pm 0.20}{(0.315 - 0.008)}$	$\frac{8.00 \pm 0.20}{(0.315 - 0.008)}$
Reel Width	W ₁	$\frac{13.5}{(0.531)}$ MAX.	$\frac{13.5}{(0.531)}$ MAX.
Quantity per Reel	--	4,000	4,000

Specifications are subject to change without notice.
Customers should verify actual device performance in their specific applications.

REV. 07/05

COPYRIGHT© 2003, BOURNS, INC. LITHO IN U.S.A. 10/03 e/IPA0303