



Small Signal Switching Diode, High Voltage

Features

- For surface mounted applications
- Low profile package
- Ideal for automated placement
- Glass passivated
- High temperature soldering: 260 °C/10 s at terminals
- Wave and reflow solderable
- AEC-Q101 qualified
- Compliant to RoHS directive 2002/95/EC and in accordance to WEEE 2002/96/EC
- Halogen-free according to IEC 61249-2-21 definition



RoHS
COMPLIANT
HALOGEN
FREE

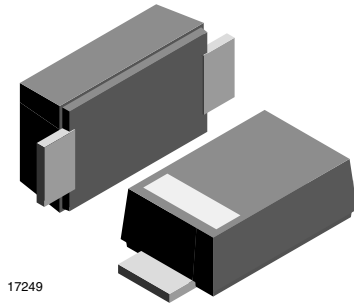

17249

Mechanical Data

Case: JEDEC DO219AB (SMF[®]) plastic case

Polarity: band denotes cathode end

Weight: approx. 15 mg

Packaging codes/options:

18/10K per 13" reel (8 mm tape)

08/3K per 7" reel (8 mm tape)

Parts Table

Part	Ordering code	Marking	Remarks
S07B-M	S07B-M-18 or S07B-M-08	UB	Tape and reel
S07D-M	S07D-M-18 or S07D-M-08	UD	Tape and reel
S07G-M	S07G-M-18 or S07G-M-08	UG	Tape and reel
S07J-M	S07J-M-18 or S07J-M-08	UJ	Tape and reel
S07M-M	S07M-M-18 or S07M-M-08	UM	Tape and reel

Absolute Maximum Ratings

$T_{amb} = 25\text{ }^{\circ}\text{C}$, unless otherwise specified

Parameter	Test condition	Part	Symbol	Value	Unit
Maximum repetitive peak reverse voltage		S07B-M	V_{RRM}	100	V
		S07D-M	V_{RRM}	200	V
		S07G-M	V_{RRM}	400	V
		S07J-M	V_{RRM}	600	V
		S07M-M	V_{RRM}	1000	V
Maximum RMS voltage		S07B-M	V_{RMS}	70	V
		S07D-M	V_{RMS}	140	V
		S07G-M	V_{RMS}	280	V
		S07J-M	V_{RMS}	420	V
		S07M-M	V_{RMS}	700	V
Maximum DC blocking voltage		S07B-M	V_{DC}	100	V
		S07D-M	V_{DC}	200	V
		S07G-M	V_{DC}	400	V
		S07J-M	V_{DC}	600	V
		S07M-M	V_{DC}	1000	V
Maximum average forward rectified current	$T_{tp} = 75\text{ }^{\circ}\text{C}$ ¹⁾		$I_{F(AV)}$	1.5	A
	$T_A = 65\text{ }^{\circ}\text{C}$ ¹⁾		$I_{F(AV)}$	0.7	A
Peak forward surge current 8.3 ms single half sine-wave	$T_L = 25\text{ }^{\circ}\text{C}$		I_{FSM}	25	A

Note:

¹⁾ Averaged over any 20 ms period

Thermal Characteristics

$T_{amb} = 25\text{ }^{\circ}\text{C}$, unless otherwise specified

Parameter	Test condition	Symbol	Value	Unit
Thermal resistance junction to ambient air ¹⁾		R_{thJA}	180	K/W
Operating junction and storage temperature range		T_J, T_{STG}	- 55 to + 150	$^{\circ}\text{C}$

Note:

¹⁾ Mounted on epoxy substrate with 3 mm x 3 mm CU pads (≥ 40 mm thick)

Electrical Characteristics

$T_{amb} = 25\text{ }^{\circ}\text{C}$, unless otherwise specified

Parameter	Test condition	Symbol	Min.	Typ.	Max.	Unit
Maximum instantaneous forward voltage	1 A ¹⁾	V_F			1.1	V
Maximum DC reverse current at rated DC blocking voltage	$T_A = 25\text{ }^{\circ}\text{C}$	I_R			10	μA
	$T_A = 125\text{ }^{\circ}\text{C}$	I_R			50	μA
Reverse recovery time	$I_F = 0.5\text{ A}, I_R = 1\text{ A}, I_{rr} = 0.25\text{ A}$	t_{rr}			1.8	μs
Typical capacitance at 4 V, MHz		C_j		4		pF

Note:

¹⁾ Pulse test: 300 μ pulse width, 1 % duty cycle

Typical Characteristics

$T_{amb} = 25\text{ }^{\circ}\text{C}$, unless otherwise specified

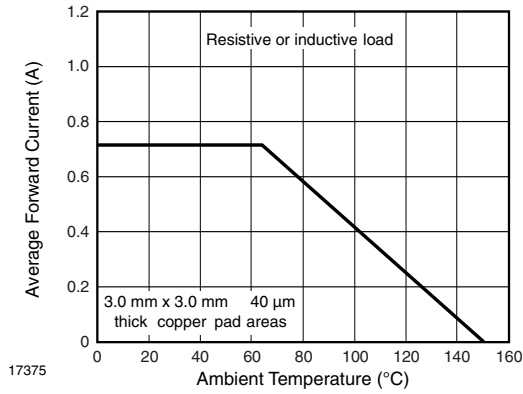

Figure 1. Forward Current Derating Curve

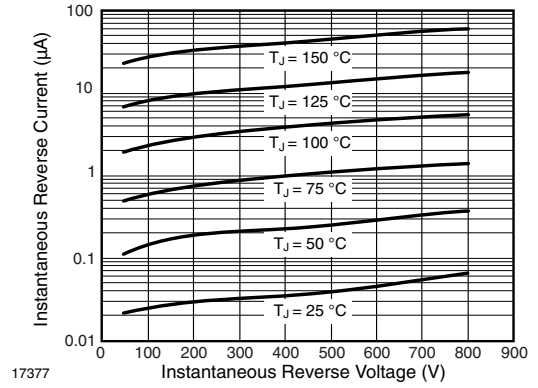

Figure 3. Typical Instantaneous Reverse Characteristics

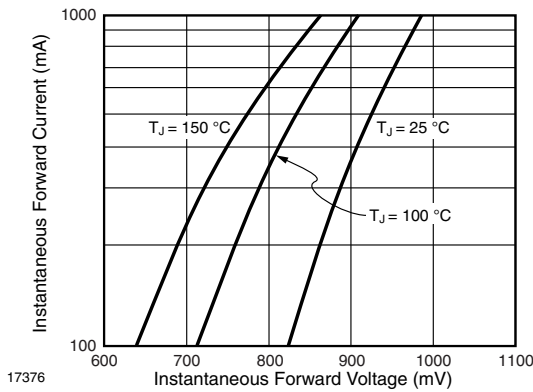

Figure 2. Typical Instantaneous Forward Characteristics

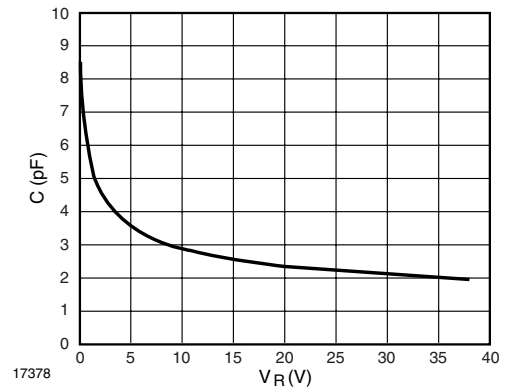

Figure 4. Capacitance vs. Reverse Voltage

S07B-M, S07D-M, S07G-M, S07J-M, S07M-M



Vishay Semiconductors

Package Dimensions in millimeters (inches): DO219AB

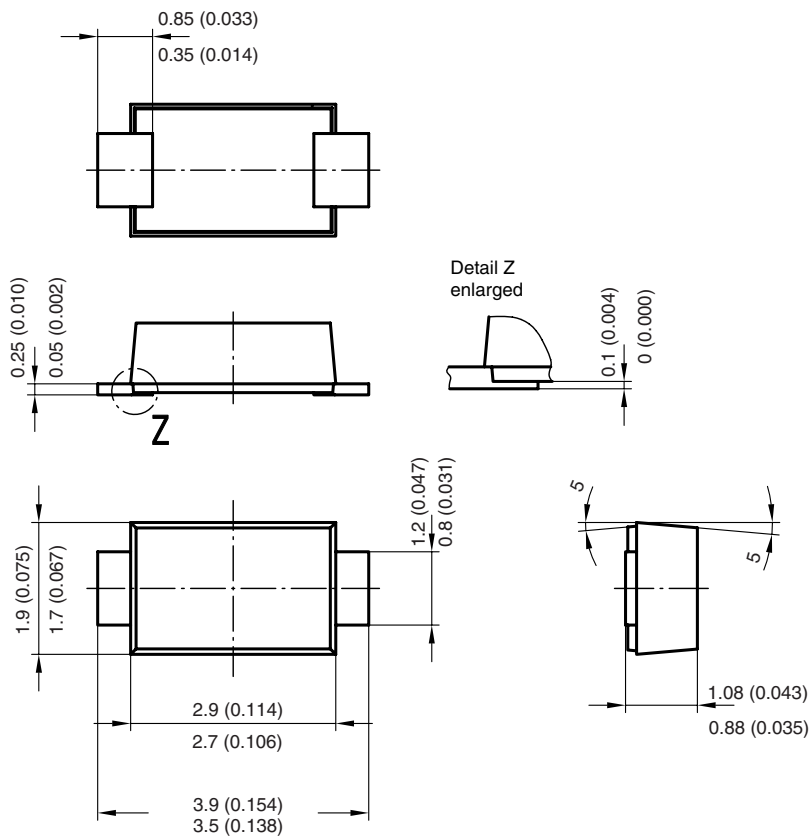

Foot print recommendation:

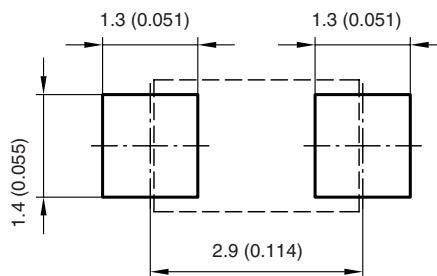

Created - Date: 15. February 2005
Rev. 3 - Date: 13. March 2007
Document no.:S8-V-3915.01-001 (4)
17247



S07B-M, S07D-M, S07G-M, S07J-M, S07M-M

Vishay Semiconductors

Blisertape Dimensions for SMF in millimeters

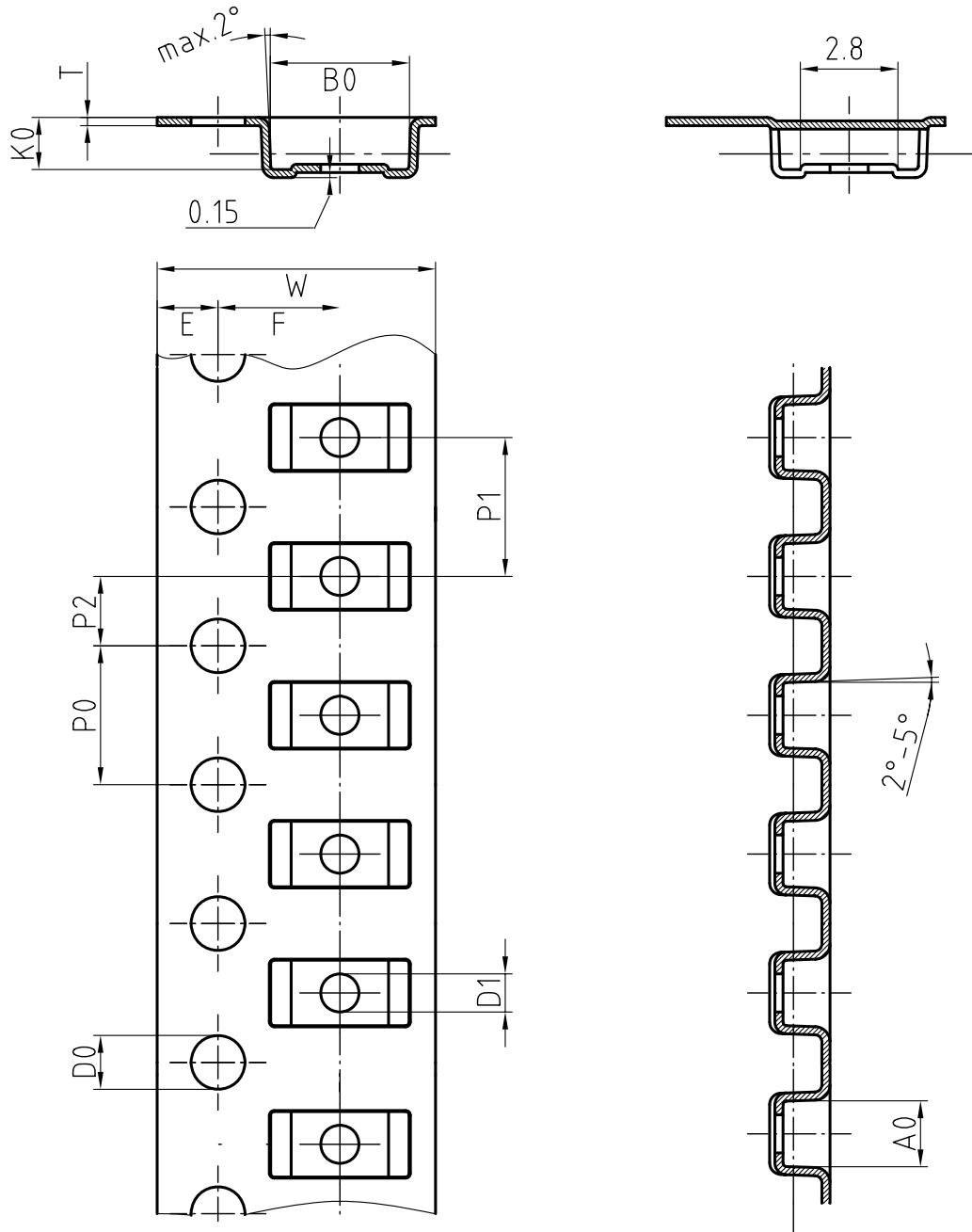

Mat:	A0	B0	K0	W	T	P0	P2	P1	D0	D1	E	F
PS	1.9	4.0	1.5	8.0	0.235	4.0	2.0	4.0	1.5	1	1.75	3.5

Document-No.: S8-V-3717.02-001 (3)

18513



Disclaimer

All product specifications and data are subject to change without notice.

Vishay Intertechnology, Inc., its affiliates, agents, and employees, and all persons acting on its or their behalf (collectively, "Vishay"), disclaim any and all liability for any errors, inaccuracies or incompleteness contained herein or in any other disclosure relating to any product.

Vishay disclaims any and all liability arising out of the use or application of any product described herein or of any information provided herein to the maximum extent permitted by law. The product specifications do not expand or otherwise modify Vishay's terms and conditions of purchase, including but not limited to the warranty expressed therein, which apply to these products.

No license, express or implied, by estoppel or otherwise, to any intellectual property rights is granted by this document or by any conduct of Vishay.

The products shown herein are not designed for use in medical, life-saving, or life-sustaining applications unless otherwise expressly indicated. Customers using or selling Vishay products not expressly indicated for use in such applications do so entirely at their own risk and agree to fully indemnify Vishay for any damages arising or resulting from such use or sale. Please contact authorized Vishay personnel to obtain written terms and conditions regarding products designed for such applications.

Product names and markings noted herein may be trademarks of their respective owners.