

D4SBS4

40V 4A

特長

- 薄型 SIP パッケージ
- SBDブリッジ
- 低 V_F

Feature

- Thin-SIP
- SBD Bridge
- Low V_F

■ 外観図 OUTLINE

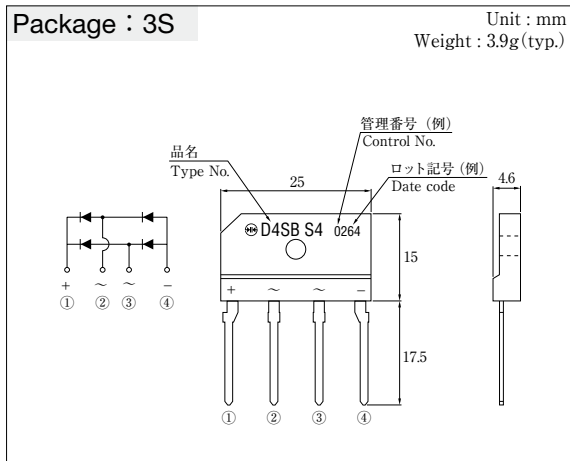

外形図については新電元 Web サイト又は〈半導体製品一覧表〉をご参照下さい。捺印表示については捺印仕様をご確認下さい。
For details of outline dimensions, refer to our web site or the Semiconductor Short Form Catalog. As for the marking, refer to the specification "Marking, Terminal Connection."

■ 定格表 RATINGS

● 絶対最大定格 Absolute Maximum Ratings (指定のない場合 $T_C=25^\circ\text{C}$ / unless otherwise specified)

項目 Item	記号 Symbol	条件 Conditions	品名 Type No.	D4SBS4	単位 Unit	
保存温度 Storage Temperature	T_{stg}			-55~150	$^\circ\text{C}$	
接合部温度 Operation Junction Temperature	T_j			150	$^\circ\text{C}$	
せん頭逆電圧 Maximum Reverse Voltage	V_{RM}			40	V	
繰り返しせん頭サージ逆電圧 Repetitive Peak Surge Voltage	V_{RRSM}	パルス幅0.5ms, duty 1/40 Pulse width 0.5ms, duty 1/40		45	V	
出力電流 Average Rectified Forward Current	I_O	50Hz 正弦波, 抵抗負荷 50Hz sine wave, Resistance load	フィン付き With heatsink	$T_C=116^\circ\text{C}$	4	A
			フィンなし Without heatsink	$T_a=33^\circ\text{C}$	2.3	
せん頭サージ順電流 Peak Surge Forward Current	I_{FSM}	50Hz 正弦波, 非繰り返し1サイクルせん頭値, $T_j=25^\circ\text{C}$ 50Hz sine wave, Non-repetitive 1 cycle peak value, $T_j=25^\circ\text{C}$		60	A	
繰り返しせん頭サージ逆電力 Repetitive Peak Surge Reverse Power	P_{RRSM}	パルス幅10 μs , 1素子当たり, $T_j=25^\circ\text{C}$ Pulse width 10 μs , per diode, $T_j=25^\circ\text{C}$		160	W	
絶縁耐圧 Dielectric Strength	V_{dis}	一括端子・ケース間, AC 1分間印加 Terminals to Case, AC 1 minute		2	kV	
締め付けトルク Mounting Torque	TOR	(推奨値: 0.5 N \cdot m) (Recommended torque : 0.5 N \cdot m)		0.8	N \cdot m	

● 電氣的・熱的特性 Electrical Characteristics (指定のない場合 $T_C=25^\circ\text{C}$ / unless otherwise specified)

順電圧 Forward Voltage	V_F	$I_F=2\text{A}$, パルス測定, 1素子当たりの規格値 Pulse measurement, per diode	MAX	0.55	V
逆電流 Reverse Current	I_R	$V_R=V_{RM}$, パルス測定, 1素子当たりの規格値 Pulse measurement, per diode	MAX	2	mA
接合容量 Junction Capacitance	C_j	$f=1\text{MHz}$, $V_R=10\text{V}$, 1素子当たりの規格値 per diode	TYP	95	pF
熱抵抗 Thermal Resistance	θ_{jc}	接合部・ケース間, フィン付き Junction to Case, With heatsink	MAX	5.5	$^\circ\text{C}/\text{W}$
	θ_{jl}	接合部・リード間, フィンなし Junction to Lead, Without heatsink	MAX	6	
	θ_{ja}	接合部・周囲間, フィンなし Junction to Ambient, Without heatsink	MAX	40	

■特性図 CHARACTERISTIC DIAGRAMS

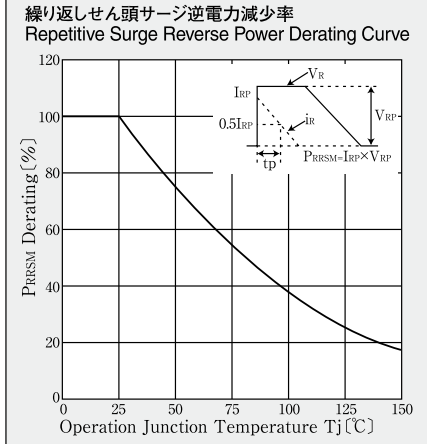
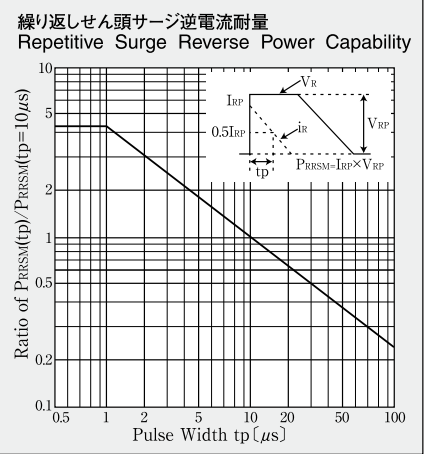
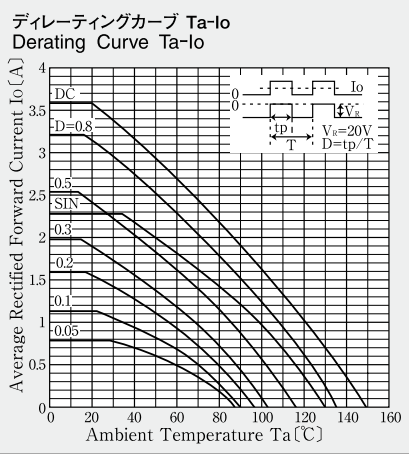
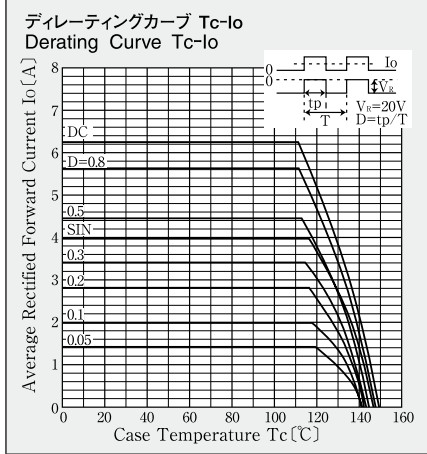
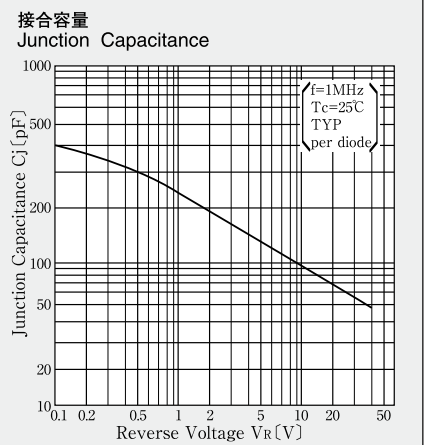
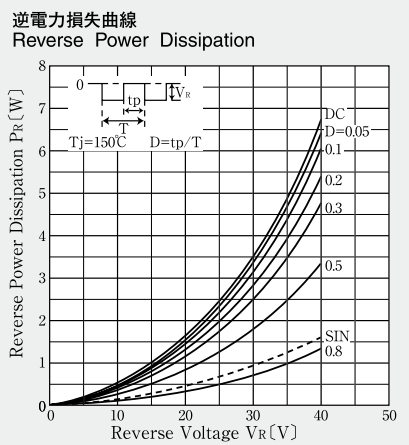
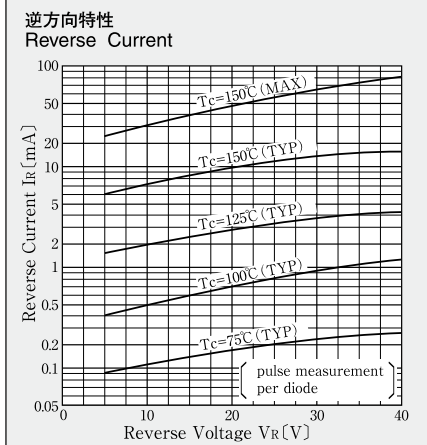
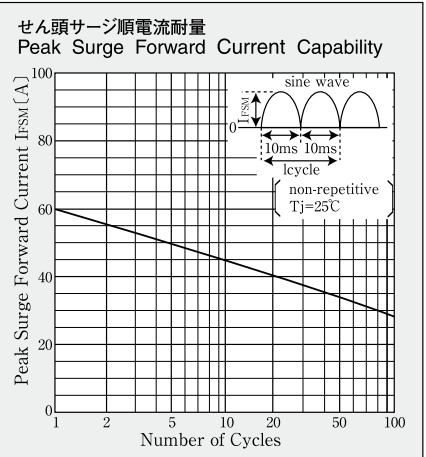
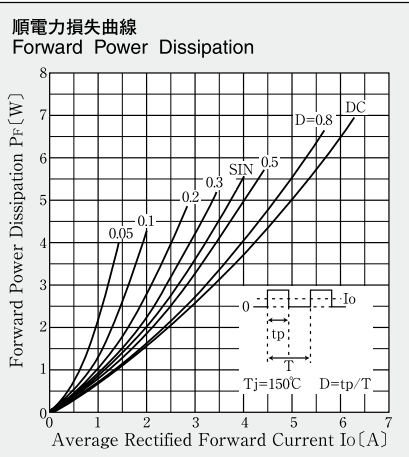
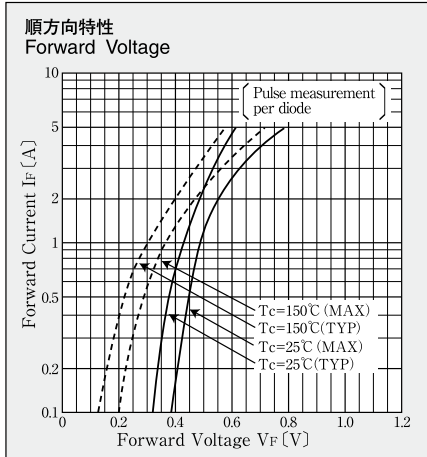

* Sine wave は 50Hz で測定しています。
* 50Hz sine wave is used for measurements.
* 半導体製品の特性は一般的にバラツキを持ってあります。
Typical は統計的な実力を表しています。
* Semiconductor products generally have characteristic variation.
Typical is a statistical average of the device's ability.