

BUT12AX

Silicon diffused power transistor

Rev. 01 — 16 June 2004

Product data

1. Product profile

1.1 Description

High voltage, high speed, NPN power transistor in a plastic package.

1.2 Features

- Isolated package
- Fast switching.

1.3 Applications

- Inverters
- Switching regulators
- Motor control systems
- DC-to-DC converters.

1.4 Quick reference data

- $V_{CESM} \leq 1000 \text{ V}$
- $I_C \leq 8 \text{ A}$
- $P_{tot} \leq 23 \text{ W}$
- $t_f \leq 0.8 \mu\text{s}$.

2. Pinning information

Table 1: Pinning - SOT186A (TO-220F), simplified outline and symbol

Pin	Description	Simplified outline	Symbol
1	base (b)		
2	collector (c)		
3	emitter (e)		
mb	mounting base; isolated		

SOT186A (TO-220F)



PHILIPS

3. Ordering information

Table 2: Ordering information

Type number	Package		Version
	Name	Description	
BUT12AX	TO-220F	Plastic single-ended package; isolated heatsink mounted; 1 mounting hole; 3 leads.	SOT186A

4. Limiting values

Table 3: Limiting values

In accordance with the Absolute Maximum Rating System (IEC 60134).

Symbol	Parameter	Conditions	Min	Max	Unit
V_{CESM}	peak collector-emitter voltage	$V_{BE} = 0\text{ V}$	-	1000	V
V_{CEO}	collector-emitter voltage	base open circuit	-	450	V
I_C	collector current	Figure 2 and 3	-	8	A
I_{Csat}	collector saturation current		-	5	A
I_{CM}	peak collector current	Figure 3	-	20	A
I_B	base current (DC)		-	4	A
I_{BM}	peak base current		-	6	A
P_{tot}	total power dissipation	$T_h = 25\text{ °C}$; Figure 1	[1] -	23	W
T_{stg}	storage temperature		-65	+150	°C
T_j	junction temperature		-	+150	°C

[1] Mounted without heatsink compound.

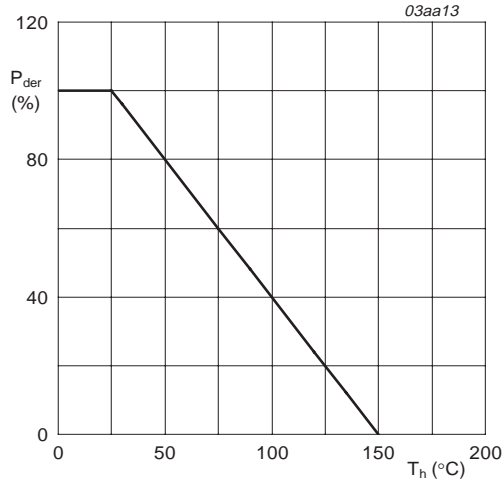

$$P_{der} = \frac{P_{tot}}{P_{tot(25^\circ C)}} \times 100\%$$

Fig 1. Normalized total power dissipation as a function of heatsink temperature.

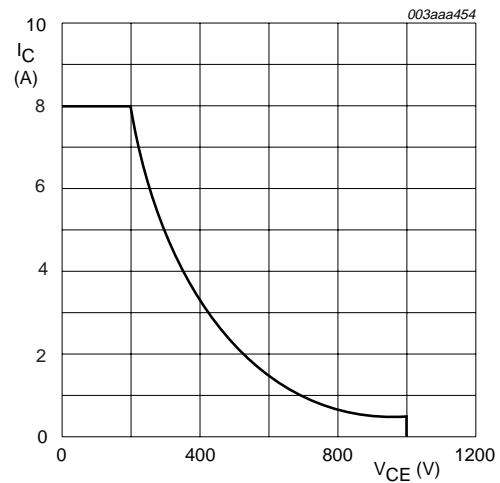

$V_{BE} = -1 \text{ V to } -5 \text{ V}; T_h = 100^\circ \text{C}.$

Fig 2. Reverse bias safe operating area; continuous collector current as a function of collector-emitter voltage.

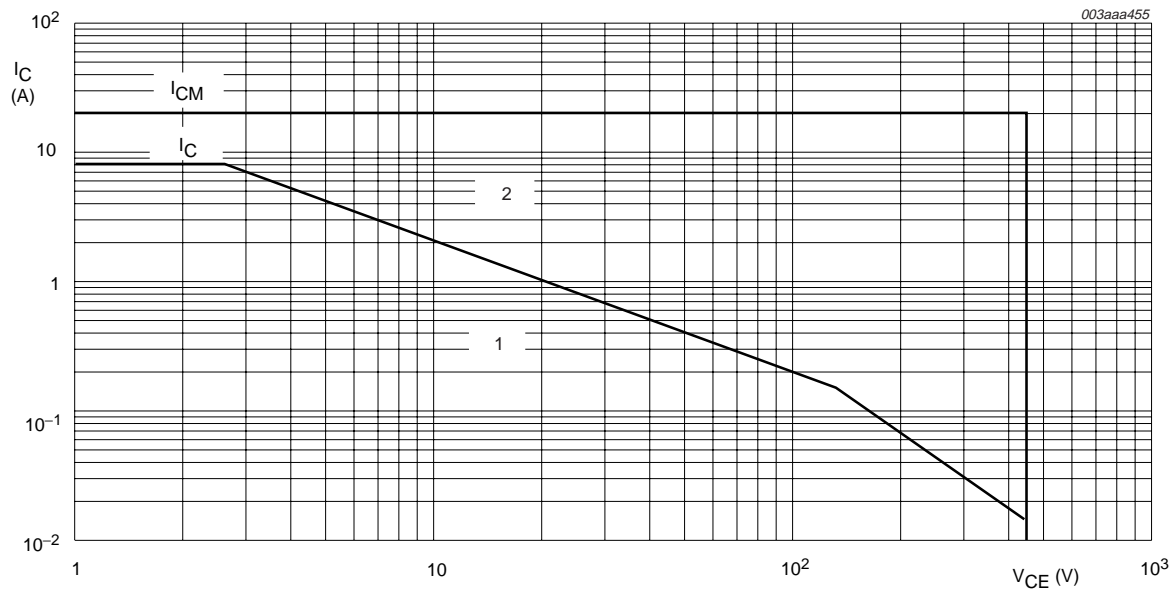

$T_h = 25^\circ \text{C}$

- 1 - Region of permissible DC operation.
- 2 - Permissible extension for repetitive operation.

Fig 3. Forward bias safe operating area; continuous and peak collector currents as a function of collector-emitter voltage.

5. Thermal characteristics

Table 4: Thermal characteristics

Symbol	Parameter	Conditions	Min	Typ	Max	Unit	
$R_{th(j-h)}$	thermal resistance from junction to heatsink	Mounted without heatsink compound	[1]	-	-	5.5	K/W
		Mounted with heatsink compound	[1]	-	-	3.9	K/W
$R_{th(j-a)}$	thermal resistance from junction to ambient		-	55	-	K/W	

[1] External heatsink connected to mounting base.

6. Characteristics

Table 5: Characteristics

$T_j = 25\text{ °C}$ unless otherwise specified.

Symbol	Parameter	Conditions	Min	Typ	Max	Unit	
Static characteristics							
V_{CE0sus}	collector-emitter sustaining voltage	$I_C = 100\text{ mA}$; $I_{Boff} = 0\text{ A}$; $L = 25\text{ mH}$; Figure 9 and 10	400	-	-	V	
V_{CEsat}	collector-emitter saturation voltage	$I_C = 5\text{ A}$; $I_B = 1\text{ A}$; Figure 5	-	-	1.5	V	
V_{BEsat}	base-emitter saturation voltage	$I_C = 5\text{ A}$; $I_B = 1\text{ A}$; Figure 4	-	-	1.5	V	
I_{CES}	collector-emitter cut-off current	$V_{CE} = V_{CESM}$; $V_{BE} = 0\text{ V}$					
		$T_j = 25\text{ °C}$	[1]	-	-	1	mA
		$T_j = 125\text{ °C}$	[1]	-	-	3	mA
h_{FE}	DC current gain	$V_{CE} = 5\text{ V}$; Figure 8					
		$I_C = 10\text{ mA}$	10	18	35		
		$I_C = 1\text{ A}$	10	20	35		
Dynamic characteristics							
t_{on}	turn-on time	$I_{Con} = 5\text{ A}$; $I_{Bon} = I_{Boff} = 1\text{ A}$; resistive load; Figure 11 and 12	-	-	1	μs	
t_s	carrier storage time	$I_{Con} = 5\text{ A}$; $I_{Bon} = I_{Boff} = 1\text{ A}$; resistive load; Figure 11 and 12	[2]	-	-	4	μs
		$I_{Con} = 5\text{ A}$; $I_{Bon} = 1\text{ A}$; $V_{CL} = 250\text{ V}$; $T_{mb} = 100\text{ °C}$; inductive load; Figure 13 and 14	-	1.9	2.5	μs	
t_f	fall time	$I_{Con} = 5\text{ A}$; $I_{Bon} = I_{Boff} = 1\text{ A}$; resistive load; Figure 11 and 12	-	-	0.8	μs	
		$I_{Con} = 5\text{ A}$; $I_{Bon} = 1\text{ A}$; $V_{CL} = 300\text{ V}$; $T_{mb} = 100\text{ °C}$; inductive load; Figure 13 and 14	-	200	300	ns	

[1] Measured with a half-sinewave voltage.

[2] turn-off storage time

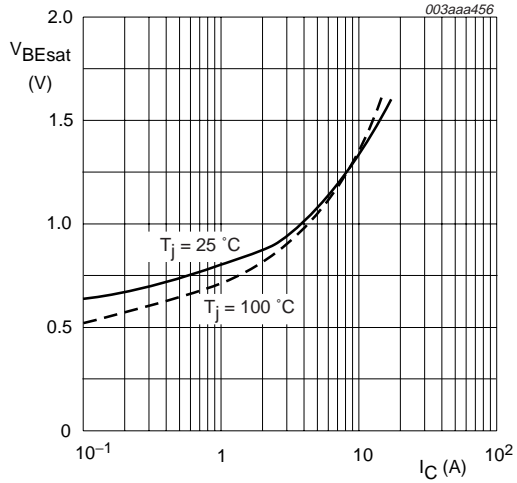

$T_j = 25^\circ\text{C}$ and 100°C

Fig 4. Base-emitter saturation voltage as a function of collector current; typical values.

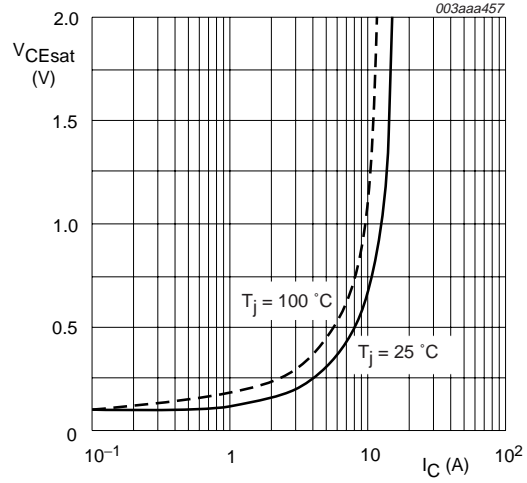

$T_j = 25^\circ\text{C}$ and 100°C

Fig 5. Collector-emitter saturation voltage as a function of collector current; typical values.

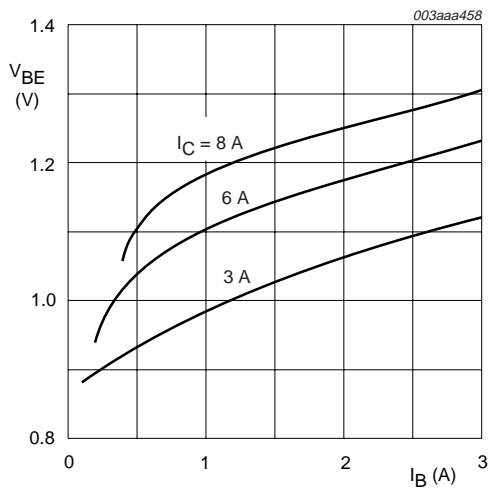

$T_j = 25^\circ\text{C}$

Fig 6. Base-emitter voltage as a function of base current; typical values.

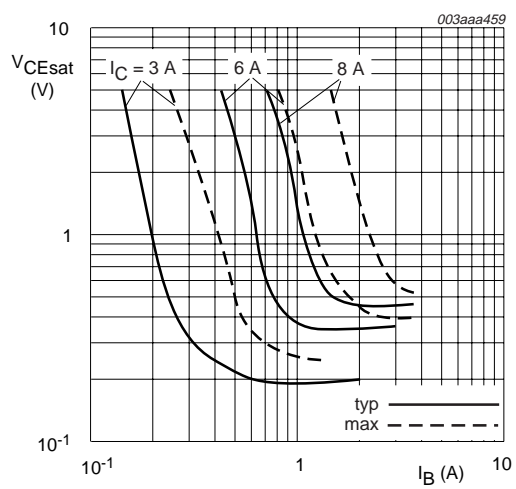
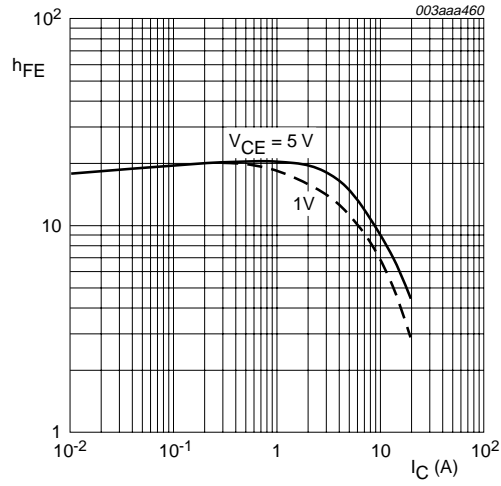

Fig 7. Collector-emitter saturation voltage as a function base current; typical and maximum values.



$V_{CE} = 5\text{ V and }1\text{ V}$

Fig 8. DC current gain as a function of collector current; typical values.

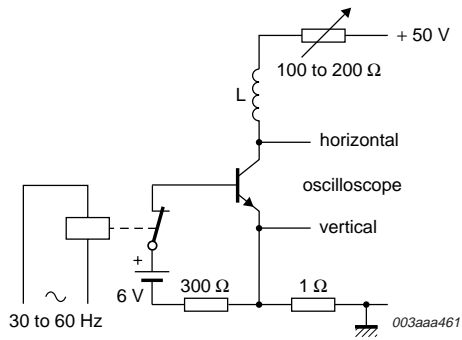

Fig 9. Test circuit for collector-emitter sustaining voltage.

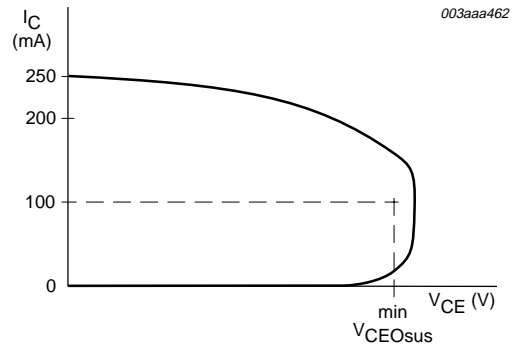
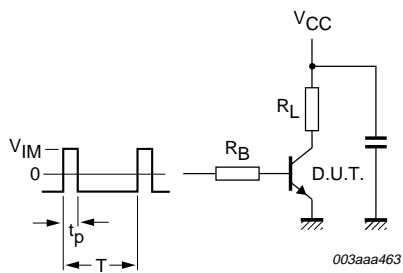

Fig 10. Oscilloscope display for collector-emitter sustaining voltage.



$V_{CC} = 250\text{ V}$; $t_p = 20\ \mu\text{s}$; $V_{IM} = -6\text{ V to } 8\text{ V}$; $t_p/T = 0.01$.
The values of R_B and R_L are selected in accordance with I_{Con} and I_{Bon} requirements.

Fig 11. Test circuit for resistive load switching times

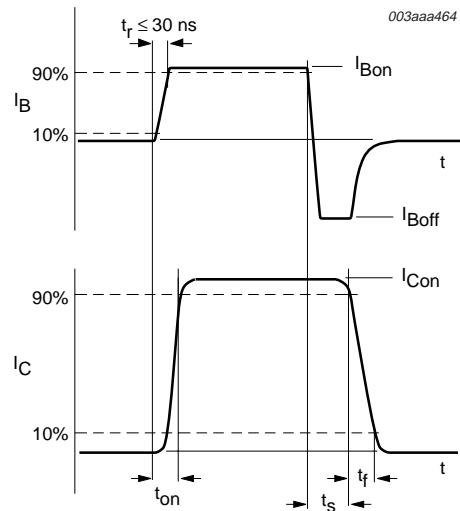
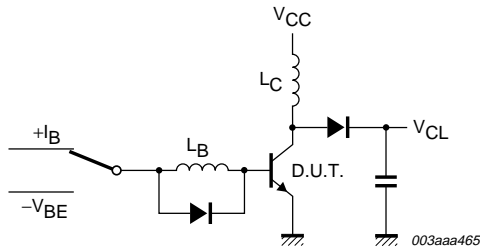

Fig 12. Switching time waveforms with resistive load.



$V_{CL} \leq 1000 \text{ V}$; $V_{CC} = 30 \text{ V}$; $V_{BE} = -1 \text{ V to } -5 \text{ V}$;
 $L_B = 1 \mu\text{H}$; $L_C = 200 \mu\text{H}$

Fig 13. Test circuit for inductive load switching and reverse bias safe operating area.

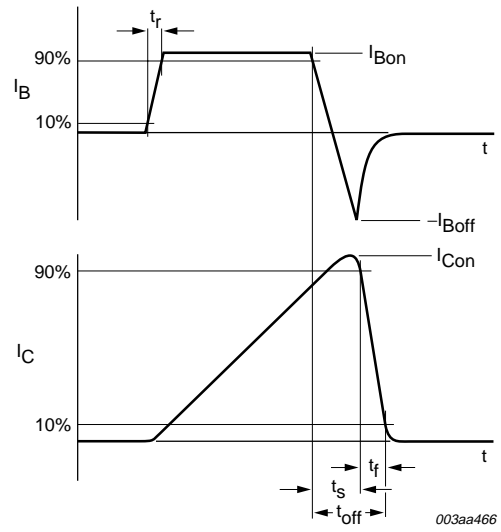

Fig 14. Switching time waveforms with inductive load.

7. Isolation characteristics

Table 6: Isolation characteristics

Symbol	Parameter	Conditions	Min.	Typ.	Max.	Unit
$V_{isol(RMS)M}$	Peak RMS isolation voltage from all three terminals to external heatsink.	$f = 50 \text{ to } 60 \text{ Hz}$; sinusoidal waveform; $RH \leq 65\%$; clean and dust-free.	-	-	2500	V
C_{c-h}	Capacitance from collector to external heatsink.		-	12	-	pF

8. Package outline

Plastic single-ended package; isolated heatsink mounted;
1 mounting hole; 3 lead TO-220 'full pack'

SOT186A

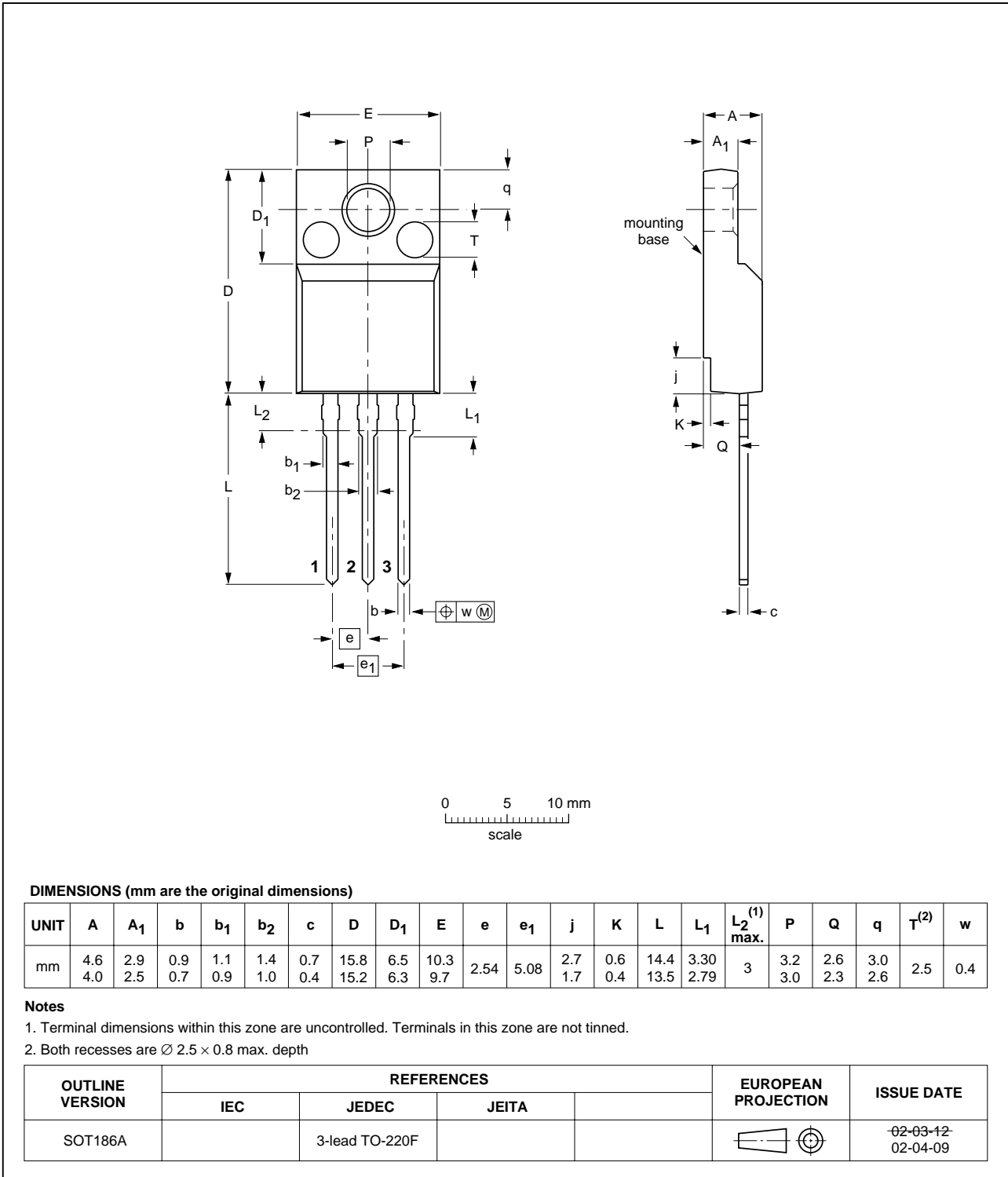

Fig 15. SOT186A (TO-220F).

9. Revision history

Table 7: Revision history

Rev	Date	CPCN	Description
01	20040616	-	Product data (9397 750 13442)

10. Data sheet status

Level	Data sheet status ^[1]	Product status ^{[2][3]}	Definition
I	Objective data	Development	This data sheet contains data from the objective specification for product development. Philips Semiconductors reserves the right to change the specification in any manner without notice.
II	Preliminary data	Qualification	This data sheet contains data from the preliminary specification. Supplementary data will be published at a later date. Philips Semiconductors reserves the right to change the specification without notice, in order to improve the design and supply the best possible product.
III	Product data	Production	This data sheet contains data from the product specification. Philips Semiconductors reserves the right to make changes at any time in order to improve the design, manufacturing and supply. Relevant changes will be communicated via a Customer Product/Process Change Notification (CPCN).

[1] Please consult the most recently issued data sheet before initiating or completing a design.

[2] The product status of the device(s) described in this data sheet may have changed since this data sheet was published. The latest information is available on the Internet at URL <http://www.semiconductors.philips.com>.

[3] For data sheets describing multiple type numbers, the highest-level product status determines the data sheet status.

11. Definitions

Short-form specification — The data in a short-form specification is extracted from a full data sheet with the same type number and title. For detailed information see the relevant data sheet or data handbook.

Limiting values definition — Limiting values given are in accordance with the Absolute Maximum Rating System (IEC 60134). Stress above one or more of the limiting values may cause permanent damage to the device. These are stress ratings only and operation of the device at these or at any other conditions above those given in the Characteristics sections of the specification is not implied. Exposure to limiting values for extended periods may affect device reliability.

Application information — Applications that are described herein for any of these products are for illustrative purposes only. Philips Semiconductors make no representation or warranty that such applications will be suitable for the specified use without further testing or modification.

12. Disclaimers

Life support — These products are not designed for use in life support appliances, devices, or systems where malfunction of these products can reasonably be expected to result in personal injury. Philips Semiconductors customers using or selling these products for use in such applications do so at their own risk and agree to fully indemnify Philips Semiconductors for any damages resulting from such application.

Right to make changes — Philips Semiconductors reserves the right to make changes in the products - including circuits, standard cells, and/or software - described or contained herein in order to improve design and/or performance. When the product is in full production (status 'Production'), relevant changes will be communicated via a Customer Product/Process Change Notification (CPCN). Philips Semiconductors assumes no responsibility or liability for the use of any of these products, conveys no licence or title under any patent, copyright, or mask work right to these products, and makes no representations or warranties that these products are free from patent, copyright, or mask work right infringement, unless otherwise specified.

Contact information

For additional information, please visit <http://www.semiconductors.philips.com>.

For sales office addresses, send e-mail to: sales.addresses@www.semiconductors.philips.com.

Fax: +31 40 27 24825

Contents

1	Product profile	1
1.1	Description	1
1.2	Features	1
1.3	Applications	1
1.4	Quick reference data	1
2	Pinning information	1
3	Ordering information	2
4	Limiting values	2
5	Thermal characteristics	4
6	Characteristics	4
7	Isolation characteristics	8
8	Package outline	9
9	Revision history	10
10	Data sheet status	11
11	Definitions	11
12	Disclaimers	11

© Koninklijke Philips Electronics N.V. 2004.
Printed in The Netherlands

All rights are reserved. Reproduction in whole or in part is prohibited without the prior written consent of the copyright owner.

The information presented in this document does not form part of any quotation or contract, is believed to be accurate and reliable and may be changed without notice. No liability will be accepted by the publisher for any consequence of its use. Publication thereof does not convey nor imply any license under patent- or other industrial or intellectual property rights.

Date of release: 16 June 2004

Document order number: 9397 750 13442



PHILIPS

Let's make things better.