

## VCC6-Q Series

### 3.3 volt LVPECL Crystal Oscillator, Output Frequencies > 270MHz

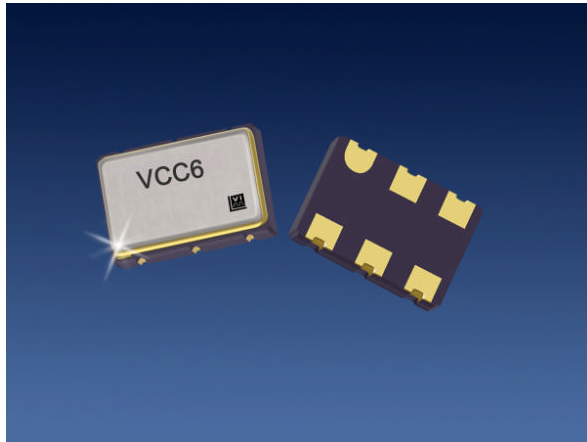

The VCC6 Crystal Oscillator

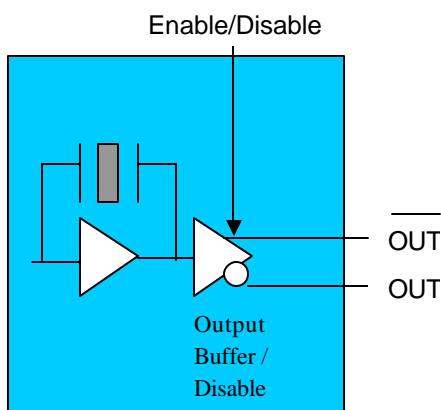

#### Features

- 3.3V LVPECL
- Output frequencies from 270 to 800 MHz
- Enable/Disable for test and board debug
- -10/70 or -40/85 °C operating temperature
- Hermetically sealed ceramic SMD package
- Product is compliant to RoHS directive  and fully compatible with lead free assembly

#### Applications

- SONET/SDH/DWDM
- Fiber Channel
- Ethernet, Gigabit Ethernet
- Storage Area Network
- Digital Video
- Broadband Access

#### Description

Vectron's VCC6 Crystal Oscillator (XO) is quartz stabilized square wave generator with a LV-PECL output, operating off a 3.3 volt supply.

# VCC6-Q 3.3v LVPECL Crystal Oscillator, Output Frequencies > 270MHZ

## Performance Characteristics

**Table 1. Electrical Performance**

Parameter	Symbol	Min	Typical	Maximum	Units
Frequency	$f_o$	270		800	MHz
Supply Voltage <sup>1</sup> ,	$V_{DD}$	3.15		3.45	V
Supply Current	$I_{DD}$			100	mA
Output Logic Levels, -10/70°C					
Output Logic High <sup>2</sup>	$V_{OH}$	$V_{DD}-1.025$		$V_{DD}-0.880$	V
Output Logic Low <sup>2</sup>	$V_{OL}$	$V_{DD}-1.810$		$V_{DD}-1.620$	V
Output Logic Levels, -40/85°C					
Output Logic High <sup>2</sup>	$V_{OH}$	$V_{DD}-1.085$		$V_{DD}-0.880$	V
Output Logic Low <sup>2</sup>	$V_{OL}$	$V_{DD}-1.830$		$V_{DD}-1.555$	V
Transition Times					
Rise Time <sup>2</sup>	$t_R$			600	ps
Fall Time <sup>2</sup>	$t_F$			600	ps
Symmetry or Duty Cycle <sup>3</sup>	SYM	45	50	55	%
Operating temperature (ordering option)	$T_{OP}$	-10/70 or -40/85			°C
Stability (ordering option) <sup>4</sup>	$\Delta F/F$	$\pm 20, \pm 25, \pm 50$ or $\pm 100$			ppm
Jitter, 12kHz to 20MHz <sup>5</sup>			2		ps
Period RMS Jitter			4		
Period p/p Jitter			30		
Output Enabled <sup>6</sup>	$V_{IH}$	$0.7 \cdot V_{DD}$			V
Output Disabled <sup>6</sup>	$V_{IL}$			$0.3 \cdot V_{DD}$	V
Enable/Disable Leakage Current	$I_{IL}$			$\pm 200$	uA
Output Enable Pull-Up Resistor <sup>6</sup>			100		

1. A 0.01uF and a 0.1uF capacitor should be located as close to the supply as possible and terminated to ground.

2. Figure 1 defines these parameters. Figure 2 illustrates the operating conditions under which these parameters are tested and specified.

3. Symmetry is measured defined as On Time/Period.

4. Includes calibration tolerance, operating temperature, supply voltage variations, aging (40 degreesC/10 years) and shock and vibration (not under operation).

5. Measurements made on a VCC6-QAB-622M080 using a LeCroy 8600, 25K samples.

6. Output will be enabled if Enable/Disable is left open.

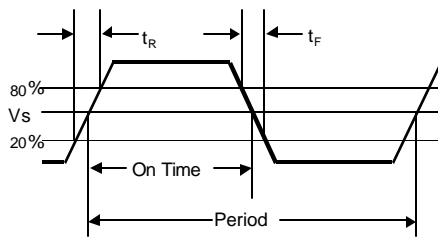

**Figure 1. Output Waveform**

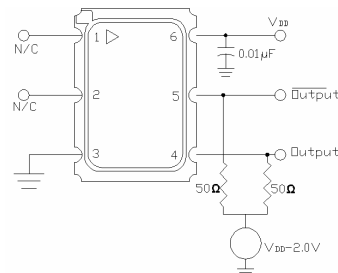
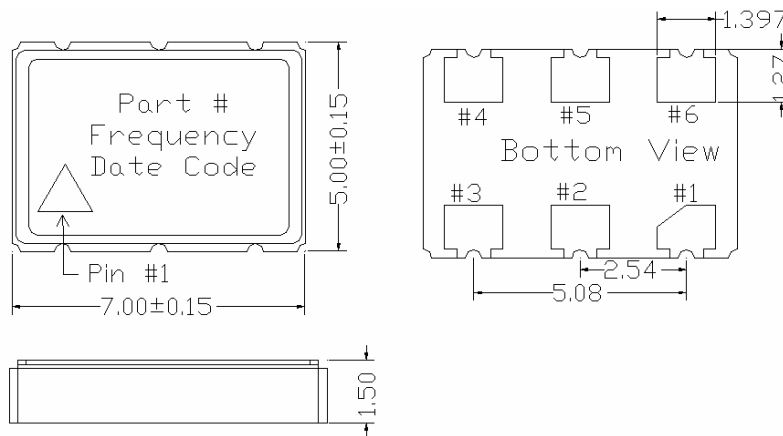

**Figure 2. Typical Output Test Conditions (25±5°C)**

## VCC6-Q 3.3v LVPECL Crystal Oscillator, Output Frequencies > 270MHZ

Table 2. VCC6-QAx Pinout		
Pin #	Symbol	Function
1	NC	This pin has no internal connection and is floating.
2	E/D	Enable/Disable Function
3	GND	Ground
4	$f_o$	Output Frequency
5	$Cf_o$	Complementary Output Frequency
6	$V_{DD}$	Supply Voltage

Table 3. VCC6-QCx Pinout		
Pin #	Symbol	Function
1	E/D	Enable/Disable Function
2	NC	This pin has no internal connection and is floating.
3	GND	Ground
4	$f_o$	Output Frequency
5	$Cf_o$	Complementary Output Frequency
6	$V_{DD}$	Supply Voltage



Contact pads are Gold over Nickel plating  
**Figure 3. VCC6-QCx Package Drawing**

## VCC6-Q 3.3v LVPECL Crystal Oscillator, Output Frequencies > 270MHZ

### Terminating PECL Outputs

The VCC6 incorporates a standard PECL output scheme, which are un-terminated emitters as shown in Figure 4. There are numerous application notes on terminating and interfacing PECL logic and the two most common methods are a single resistor to ground, Figure 5, and a pull-up/pull-down scheme as shown in Figure 6. An AC coupling capacitor is optional, depending on the application and the input logic requirements of the next stage.

One of the most important considerations is terminating the Output and Complementary Outputs equally. An unused output should not be left un-terminated, and if one of the two outputs is left open it will result in excessive jitter on both. PC board layout must take this and 50 ohm impedance matching into account. Load matching and power supply noise are the main contributors to jitter related problems.

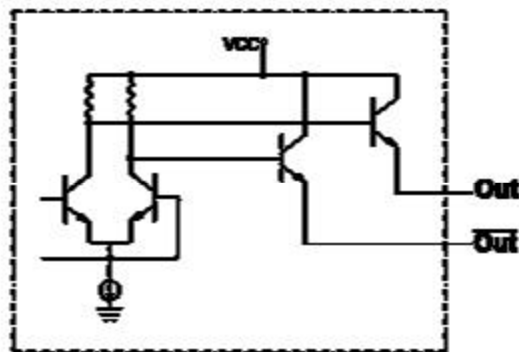

Figure 4. Standard PECL Output Configuration

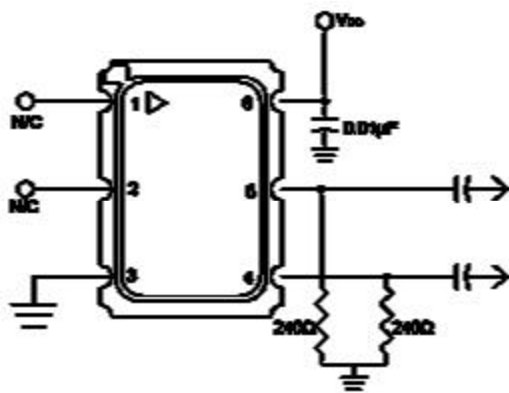

Figure 5. Single Resistor Termination  
Resistor value are typically:  
120 to 240ohms for 3.3V

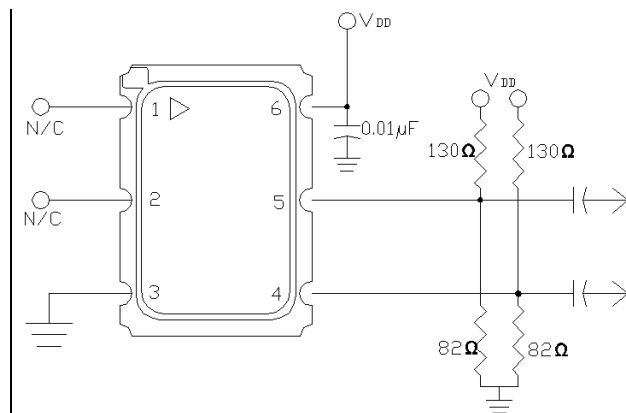

Figure 6. Pull-up Pull-down Termination  
Resistor values are typically:  
130 and 82 ohms for 3.3V

## VCC6-Q 3.3v LVPECL Crystal Oscillator, Output Frequencies > 270MHZ

### Enable/Disable Functional Description

Under normal operation the Enable/Disable is left open, or set to a logic high state, and the VCC6 is oscillating. When the E/D is set to a logic low, the oscillator stops and the both the output and complementary outputs are in a high impedance state. This helps facilitate board testing and troubleshooting.

### Absolute Maximum Ratings

Stresses in excess of the absolute maximum ratings can permanently damage the device. Functional operation is not implied at these or any other conditions in excess of conditions represented in the operational sections of this data sheet. Exposure to absolute maximum ratings for extended periods may adversely affect device reliability.

**Table 4. Absolute Maximum Ratings**

Parameter	Symbol	Ratings	Unit
Power Supply	$V_{DD}$	-0.5 to +4.6	Vdc
Enable/Disable	$V_{IN}$	-0.5 to $V_{DD}+0.5$	Vdc
Storage Temperature	$T_{storage}$	-55/125	°C

### Reliability

The VCC6 qualification tests included:

**Table 5. Environmental Compliance**

Parameter	Conditions
Mechanical Shock	MIL-STD-883 Method 2002
Mechanical Vibration	MIL-STD-883 Method 2007
Solderability	MIL-STD-883 Method 2003
Gross and Fine Leak	MIL-STD-883 Method 1014
Resistance to Solvents	MIL-STD-883 Method 2016

### Handling Precautions

Although ESD protection circuitry has been designed into the the VCC6, proper precautions should be taken when handling and mounting. VI employs a Human Body Model and a Charged-Device Model (CDM) for ESD susceptibility testing and design protection evaluation. ESD thresholds are dependent on the circuit parameters used to define the model. Although no industry wide standard has been adopted for the CDM, a standard HBM of resistance = 1.5kohms and capacitance = 100pF is widely used and therefore can be used for comparison purposes.

**Table 6. ESD Ratings**

Model	Minimum	Conditions
Human Body Model	1500	MIL-STD-883 Method 3015
Charged Device Model	1500	

## VCC6-Q 3.3v LVPECL Crystal Oscillator, Output Frequencies > 270MHZ

### IR Reflow and Suggested Pad Size Layout

The VCC6 has been qualified to meet the JEDEC standard for Pb-Free assembly. The temperatures and time intervals listed are based on the Pb-Free small body requirements and parameters are listed in Table 7. The VCC6 is hermetically sealed so an aqueous wash is not an issue.

Table 7. Reflow Profile (IPC/JEDEC J-STD-020B)		
Parameter	Symbol	Value
PreHeat Time	$t_s$	60 sec Min, 200 sec Max
Ramp Up	$R_{UP}$	3 °C/sec Max
Time Above 217 °C	$t_L$	60 sec Min, 150 sec Max
Time To Peak Temperature	$t_{AMB-P}$	480 sec Max
Time At 260 °C (max)	$t_P$	10 sec Max
Ramp Down	$R_{DN}$	6 °C/sec Max

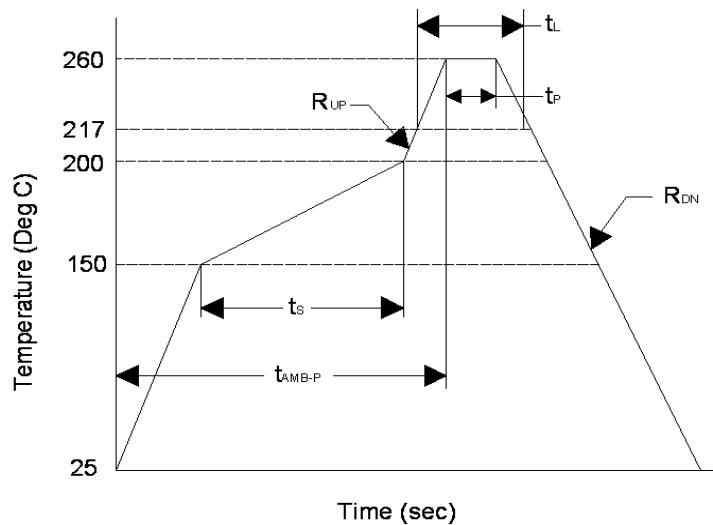

Figure 7. IR Reflow Diagram

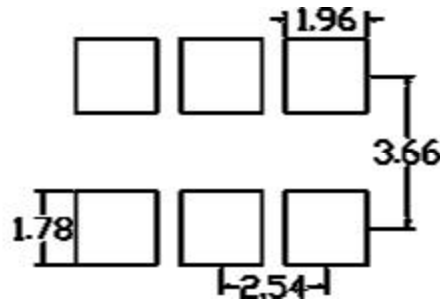

Figure 8. Pad Size Diagram

# VCC6-Q 3.3v LVPECL Crystal Oscillator, Output Frequencies > 270MHZ

## Tape and Reel

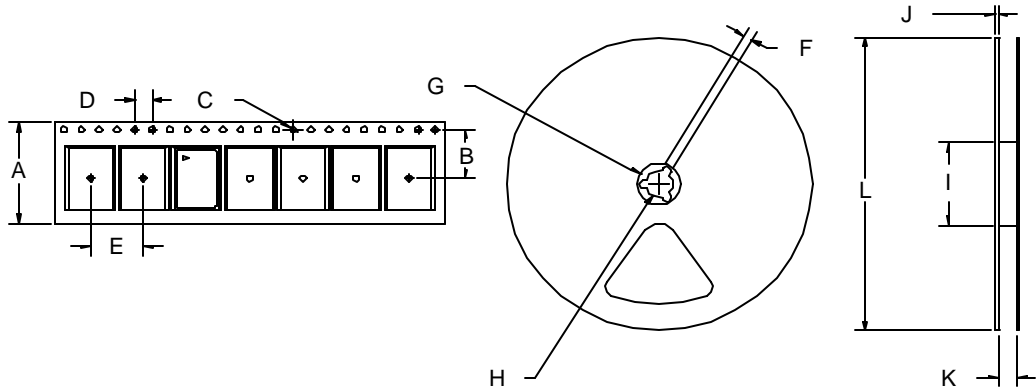

Figure 9. Tape and Reel Diagram

Table 8. Tape and Reel Dimensions (mm)													
Tape Dimensions						Reel Dimensions							# Per Reel
Product	A	B	C	D	E	F	G	H	I	J	K	L	
VCC6	16	7.5	1.5	4	8	2	21	13	60	2	17	180	250

# VCC6-Q 3.3v LVPECL Crystal Oscillator, Output Frequencies > 270MHz

Table 9. Frequencies (MHz)				
311.040	312.500	320.000	322.2656	332.000
333.000	350.000	400.000	446.000	472.000
500.000	600.000	622.080	625.000	644.5313
666.5413	669.3236	693.3265	693.4829	693.750
700.000	779.5686			

Other frequencies may be available upon request. Standard frequencies are frequencies which the crystal has been designed and does not imply a stock position.

## Ordering Information

### VCC6 – Qxx – xxxMxx

**Product Family**

Crystal Oscillator

**Supply Voltage, Output**

Q=3.3V, PECL

**Enable/Disable**

A: E/D is on Pin 2, Pin 1 is a NC

C: E/D is on Pin 1, Pin 2 is a NC

**Frequency MHz**

example: 625M00= 625.000MHz

**Stability Options/Temperature**

A: ±100ppm      -10 to 70°C

B: ±50ppm        -10 to 70°C

C: ±100ppm      -40 to 85°C

D: ±50ppm        -40 to 85°C

E: ±25ppm        -10 to 70°C

F: ±25ppm        -40 to 85°C

**NOTE:** Not all combinations of options are available.

A +/-20ppm over -10/70°C, VCC6-107-frequency, is also available.

**For Additional Information, Please Contact:**



[www.vectron.com](http://www.vectron.com)

**USA:** Vectron International • 267 Lowell Road, Hudson, NH 03051

• Tel: 1-88-VECTRON-1 • Fax: 1-888-FAX-VECTRON

**EUROPE:** Landstrasse, D-74924, Neckarbischofsheim, Germany •

Tel: 49 (0) 7268 8010 • Fax: 49 (0) 7268 801281

**ASIA:** Vectron Asia Pacific Sales 1F-2F, No.8 Workshop No.308 Fenju Rd., WaiGaoQiao Free Trade Zone, Pudong New Area Shanghai, China 200131

•Tel: 8621 50480777 • Fax: 8621 50481881

Vectron International reserves the right to make changes to the product(s) and/or information contained herein without notice. No liability is assumed as a result of their use or application. No rights under any patent accompany the sale of any such product(s) or information.

VCC6-Q 270Mhz (REVISION DATE: September7, 2005)