

Micropower, 300mA Low Dropout CMOS Regulator

Features

- 300mA output current capability
 - 300mA peak in SOT-23 package
 - 300mA continuous in MSOP package
- 300mV maximum dropout voltage at full load
- Excellent line and load regulation
- Stable with any output capacitor
- Ultra low noise with optional bypass capacitor
- Fast power-up with bypass capacitor
- "Zero" current in Shutdown mode
- Thermal overload protection
- Foldback current limiting protection
- Reverse current protection

Applications

- Notebook and palmtop computers
- Cell phones and battery powered devices
- Consumer and personal electronics
- PC Card V_{CC} and V_{PP} regulation and switching

CM3015 Regulator Family

PRODUCT	OUTPUT VOLTAGE*
CM3015-00	Adjustable
CM3015-12	1.2V
CM3015-15	1.5V
CM3015-18	1.8V
CM3015-25	2.5V
CM3015-28	2.8V
CM3015-30	3.0V
CM3015-33	3.3V

* For other output voltages, please consult factory.

Product Description

The CM3015 is a CMOS linear voltage regulator with low quiescent current, very low dropout voltage and better than 1% fixed output voltage accuracy. The CM3015 ground current is typically 150 μ A at light loads and only 165 μ A at 300mA.

Load regulation of 0.25% is maintained for peak currents up to 300mA. This is useful for supplying in-rush currents during power-up and transient conditions. The continuous output current is determined by power dissipation, package type and board layout.

A dedicated control input (EN, Active High) has been included for power-up sequencing flexibility. When this input is taken low, the regulator is disabled and the supply current will drop to near zero.

The CM3015 also features reverse current protection. This protects the device by blocking the pass transistor's parasitic diode when the output voltage is forced higher than the input. The device also incorporates overload current limiting and high temperature thermal shutdown protection.

For low noise performance and increased power supply ripple rejection, a bypass capacitor can be connected to the BYP pin. Connecting this capacitor will not significantly delay the speed of power-up.

To reduce board cost and layout size the CM3015 was designed to be stable with or without any output capacitor. This includes tiny, low ESR ceramic capacitors. The CM3015 is available in a low profile, 8-lead MSOP package and 5 and 6-lead SOT23 packages making it ideal for space critical applications.

Block Diagram

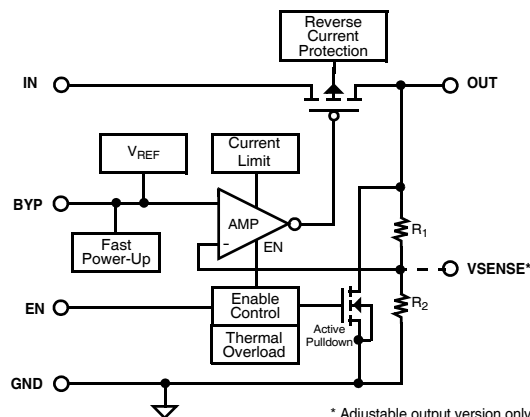

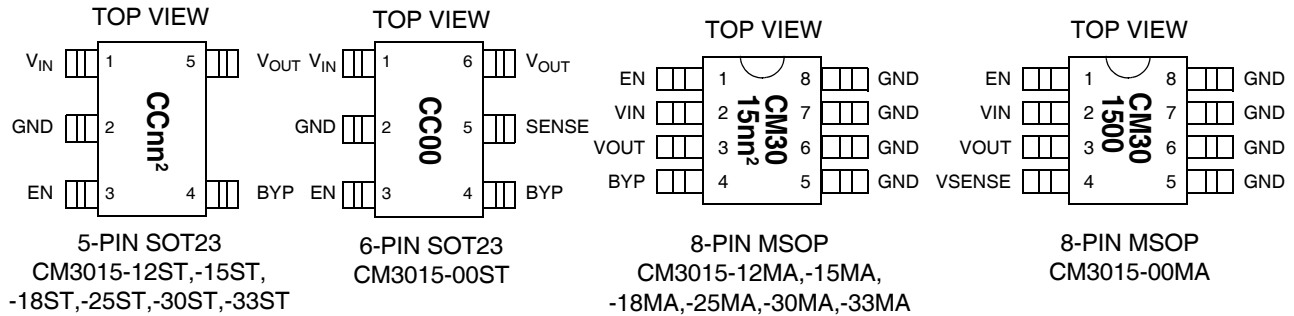
PACKAGE / PINOUT DIAGRAM (Note 1)

Notes:

- 1) These drawings are not to scale.
- 2) See Ordering Information section for part marking details.

PIN DESCRIPTIONS

SOT23-5 PIN(S)	SOT23-6 PIN(S)	MSOP-8 PIN(S)	NAME	DESCRIPTION
1	1	2	V_{IN}	V_{IN} is the input power source for the regulator. If this input is within a few inches of the main supply filter, a capacitor may not be necessary. Otherwise, an input filter capacitor of about 1-10 μ F will ensure adequate filtering.
2	2	5-8	GND	The negative reference for all voltages.
3	3	1	EN	Enable input. When this input is taken low (< 0.4V), the regulator is disabled. In this state, the supply current will drop to near zero.
4	4	4	BYP	Reference Bypass Pin. Connect to an external capacitor for noise reduction. A 10nF-100nF size ceramic capacitor is recommended.
—	5	4	VSENSE	This pin sets V_{OUT} with an external divider: $V_{OUT} = VSENSE(1 + R_1/R_2)$. R_1 is the upper resistor, like the internal divider shown on the block diagram on page 1.
5	6	3	V_{OUT}	V_{OUT} is the output voltage used to power the load. An output capacitor may not be required for stability, but its use can improve transient response, noise performance and power supply ripple rejection for frequencies over ~100kHz (see note 1).

Note 1: Tantalum, electrolytic or low cost ceramic capacitors may be used.

Ordering Information

PART NUMBERING INFORMATION			
Pins	Package	Ordering Part Number ¹	Part Marking
6	SOT23-6	CM3015-00ST	CC00
5	SOT23-5	CM3015-12ST	CC12
5	SOT23-5	CM3015-15ST	CC15
5	SOT23-5	CM3015-18ST	CC18
5	SOT23-5	CM3015-25ST	CC25
5	SOT23-5	CM3015-28ST	CC28
5	SOT23-5	CM3015-30ST	CC30
5	SOT23-5	CM3015-33ST	CC33
8	MSOP-8	CM3015-00MA	CM301500
8	MSOP-8	CM3015-12MA	CM301512
8	MSOP-8	CM3015-15MA	CM301515
8	MSOP-8	CM3015-18MA	CM301518
8	MSOP-8	CM3015-25MA	CM301525
8	MSOP-8	CM3015-28MA	CM301528
8	MSOP-8	CM3015-30MA	CM301530
8	MSOP-8	CM3015-33MA	CM301533

Note 1: Parts are shipped in Tape & Reel form unless otherwise specified.

Specifications

ABSOLUTE MAXIMUM RATINGS		
PARAMETER	RATING	UNITS
ESD Protection (HBM)	±2000	V
Pin Voltages		
V_{IN}	[GND - 0.6] to [+6.0]	V
EN	[GND - 0.6] to [$V_{CC} + 0.6$]	V
V_{OUT}	[GND - 0.6] to [$V_{CC} + 0.6$]	V
Storage Temperature Range	-40 to +150	°C
Operating Temperature Range, Junction	0 to +150	°C
Power Dissipation (Notes 1,2)	Internally Limited	W

STANDARD OPERATING CONDITIONS		
PARAMETER	RATING	UNITS
V_{IN}	2.2 to 6.0	V
Ambient Operating Temperature Range	-40 to +85	°C
Load Current	0 to 300	mA
C_{EXT} (notes 1 and 2)	0 to 50	μF

Note 1: Tantalum, electrolytic or low cost ceramic capacitors may be used.

Note 2: $V_{OUT} + 1V < V_{IN}$ & $2.5V < V_{IN} < 6V$, $I_{OUT} = 1mA$, $C_{IN} = 2.2\mu F$, $T_J = 25^\circ C$, $C_{OUT} = 2.2\mu F$, $V_{SD} = 1.5V$, unless specified otherwise. **Bold values indicate $-40^\circ C < T_J < 125^\circ C$**

Specifications (cont'd)

ELECTRICAL OPERATING CHARACTERISTICS (SEE NOTE 1)						
SYMBOL	PARAMETER	CONDITIONS	MIN	TYP	MAX	UNIT S
V_{OUT}	Regulator Output Voltage	$T_A = 25^{\circ}\text{C}$ $0^{\circ}\text{C} < T_J < 125^{\circ}\text{C}$ $-40^{\circ}\text{C} < T_J < 125^{\circ}\text{C}$	-1 -2 -3		+1 +2 +3	% % %
$V_{R\text{ LINE}}$	Line Regulation	$V_{OUT} + 1\text{V} < V_{IN} \text{ \& } 2.5\text{V} < V_{IN} < 6\text{V}$		0.1	0.2 0.4	%/V
$V_{R\text{ LOAD}}$	Load Regulation	$0\text{mA} \leq I_{LOAD} \leq 150\text{mA}$; $V_{IN} = V_{OUT} + 1\text{V}$; Note 2		0.1	0.25 0.50	%
V_{SENSE}	Reference Voltage	$T_A = 25^{\circ}\text{C}$		1.20		V
R_{DROP}	Dropout Resistance	$1\text{mA} \leq I_{LOAD} \leq 300\text{mA}$; $V_{IN} = V_{OUT}(\text{nominal}) - 100\text{mV}$		0.7	1.0 1.2	Ω
I_{GND}	Ground Current	with EN tied to V_{IN} ; $I_{LOAD} = 1\text{mA}$		150	200	μA
		with EN tied to V_{IN} ; $I_{LOAD} = 350\text{mA}$		165	250	μA
		with EN tied to GND (Disable Mode)		0.01	1	μA
V_{EN}	Enable Voltage	Regulator enabled	1.5			V
V_{DIS}	Disable Voltage	Regulator shutdown			0.40 0.18	V
I_{EN}	Enable Input Current			0.01		μA
PSSR	Power Supply Ripple Rejection	$f = 1\text{kHz}$		75		dB
E_{NOISE}	Output Noise Voltage	10Hz-100kHz; $C_{BYP} = 0.1\mu\text{F}$		30		μVrms
t_{ON}	V_{OUT} Turn-on Time	$C_{BYP} = 0\mu\text{F}$		80		μs
		$C_{BYP} = 0.1\mu\text{F}$		100		μs
I_{LIM}	Overload Current Limit			800		mA
I_{SC}	Short Circuit Current Limit	$V_{OUT} < 0.5\text{V}$		550		mA
T_{JSD}	Thermal Shutdown Junction Temperature			165		$^{\circ}\text{C}$
T_{HYST}	Thermal Hysteresis			20		$^{\circ}\text{C}$

Note 1: $V_{OUT} + 1\text{V} < V_{IN} \text{ \& } 2.5\text{V} < V_{IN} < 6\text{V}$, $I_{LOAD} = 1\text{mA}$, $C_{IN} = 2.2\mu\text{F}$, $T_J = 25^{\circ}\text{C}$, $C_{OUT} = 2.2\mu\text{F}$, $V_{SD} = 1.5\text{V}$, unless specified otherwise. **Bold values indicate $-40^{\circ}\text{C} < T_J < 125^{\circ}\text{C}$**

Note 2: Regulation voltages and dropout resistance measured at constant junction temperature using low duty cycle pulse testing.

Note 3: Line regulation is displayed as the average regulation across the full operating range measured in %/V.

THERMAL PERFORMANCE		
PACKAGE	θ_{JA} MINIMUM FOOTPRINT	θ_{JA} 1" SQUARE 2OZ. COPPER
SOT23-5 / SOT23-6	220 $^{\circ}\text{C}/\text{W}$	170 $^{\circ}\text{C}/\text{W}$
MSOP-8 Fused	160 $^{\circ}\text{C}/\text{W}$	70 $^{\circ}\text{C}/\text{W}$

Performance Information

Typical DC Characteristics (nominal conditions unless specified otherwise)

Nominal Conditions: $C_{IN} = 1\mu F$, $C_{OUT} = 2.2\mu F$, No C_{BYP} , $V_{IN} = 4.0V$, Load = 5mA (all plots measured with 3.0V V_{OUT})

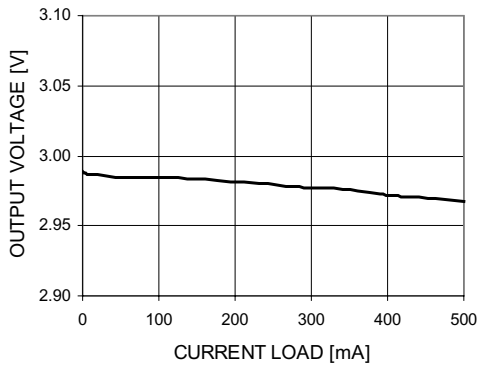

Figure 1. Load Regulation

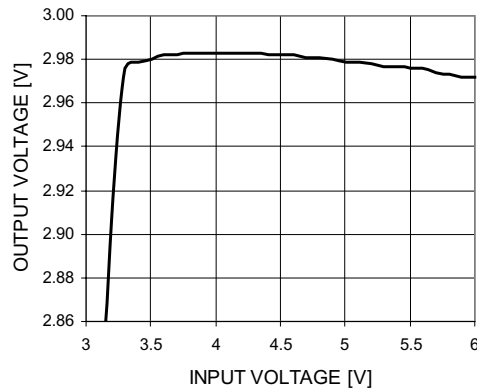

Figure 4. Line Regulation ($I_{LOAD}=300mA$)

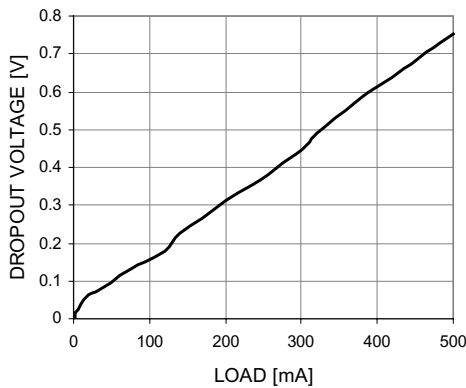

Figure 2. Dropout Voltage ($V_{OUT}=2.9V$)

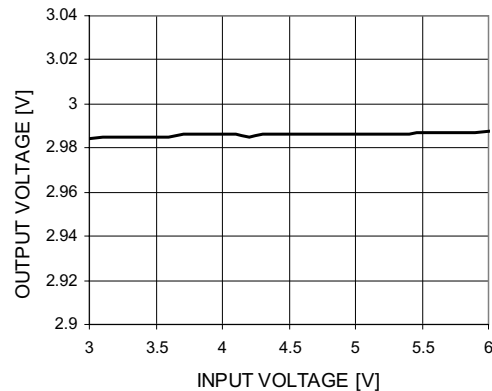

Figure 5. Line Regulation ($I_{LOAD}=5mA$)

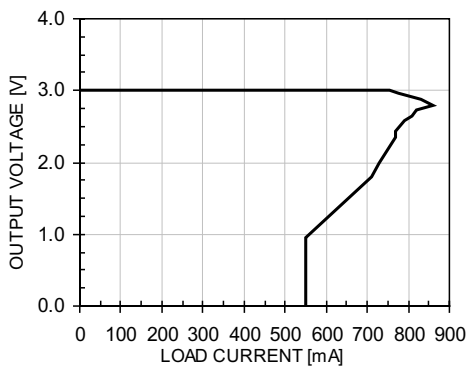

Figure 3. Foldback Current Limiting

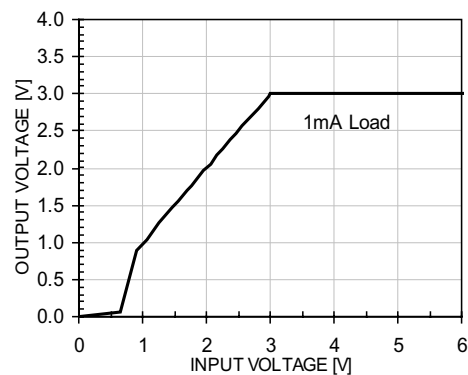

Figure 6. Line Regulation ($I_{LOAD}=1mA$)

Performance Information (cont'd)

Typical DC Characteristics (cont'd - nominal conditions unless specified otherwise)

Nominal Conditions: $C_{IN} = 1\mu F$, $C_{OUT} = 2.2\mu F$, No C_{BYP} , $V_{IN} = 4.0V$, Load = 5mA (all plots measured with 3.0V V_{OUT})

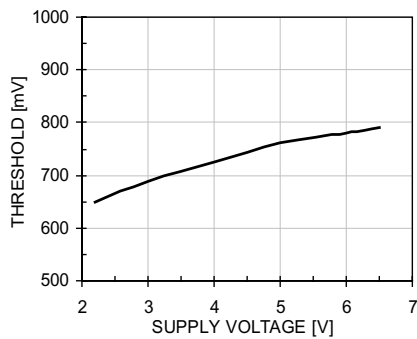

Figure 7. Enable Voltage Threshold

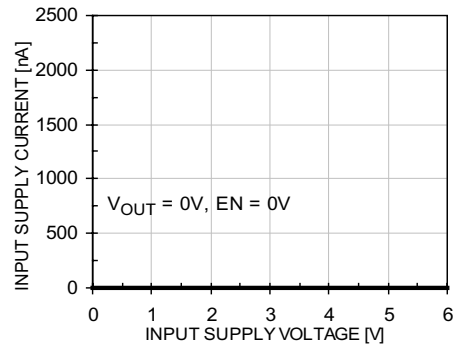

Figure 10. Input Supply Current vs. Voltage

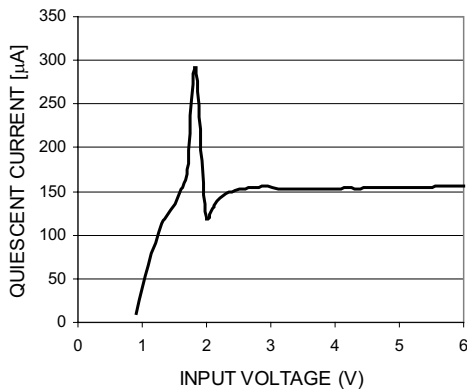

Figure 8. Supply Current vs. Voltage (EN=V_{IN}, I_{LOAD} = 5mA)

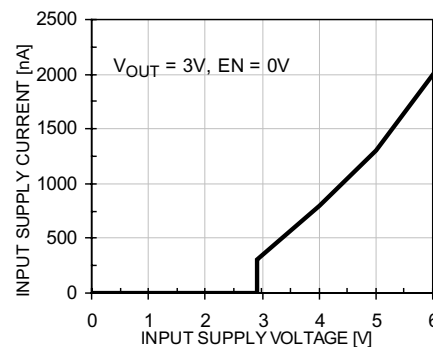

Figure 11. Input Supply Current vs. Voltage

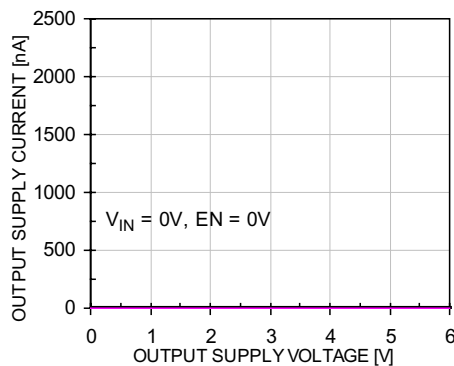

Figure 9. Output Supply Current vs. Voltage

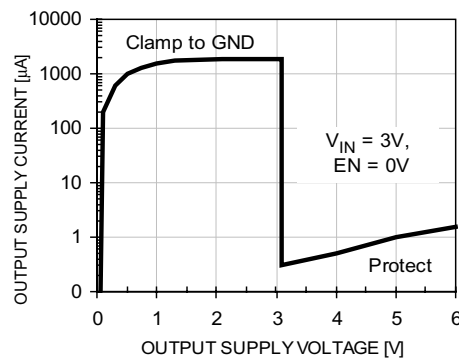

Figure 12. Output Supply Current vs. Voltage

Performance Information (cont'd)

Transient Characteristics (nominal conditions unless specified otherwise)

Nominal Conditions: $C_{IN} = 1\mu F$, $C_{OUT} = 2.2\mu F$, No C_{BYP} , $V_{IN} = 4.0V$, Load = 5mA

(all plots measured with 3.0V V_{OUT})

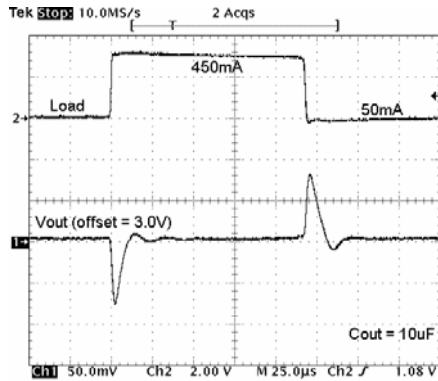

Figure 13. 10% to 90% Load Step ($t_r=1\mu s$, $C_{OUT}=10\mu F$)

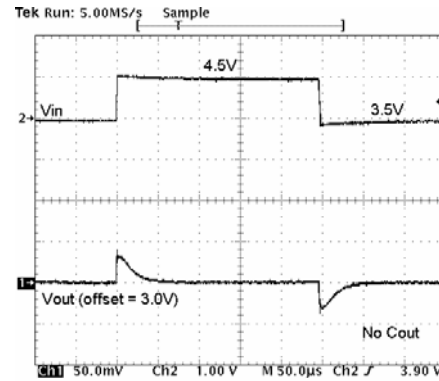

Figure 16. 3.5V - 4.5V Line Step ($t_r=1\mu s$, No C_{OUT})

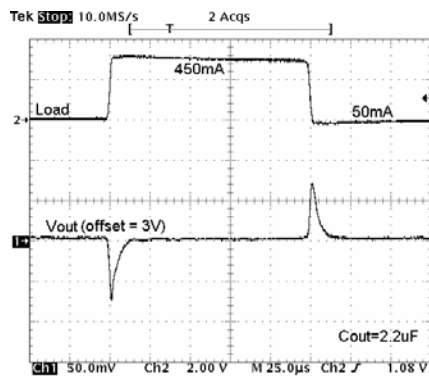

Figure 14. 10% to 90% Load Step ($t_r=1\mu s$, $C_{OUT}=2.2\mu F$)

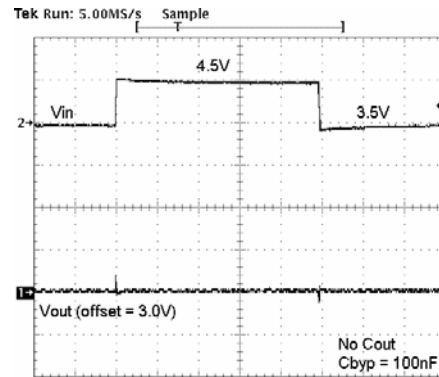

Figure 17. 3.5V - 4.5V Line Step ($t_r=1\mu s$, No C_{OUT} , $C_{BYP}=100nF$)

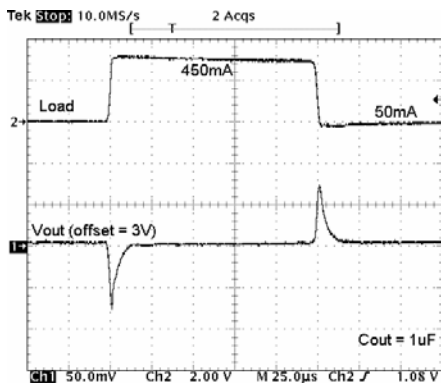

Figure 15. 10% to 90% Load Step ($t_r=1\mu s$, $C_{OUT}=1.0\mu F$)

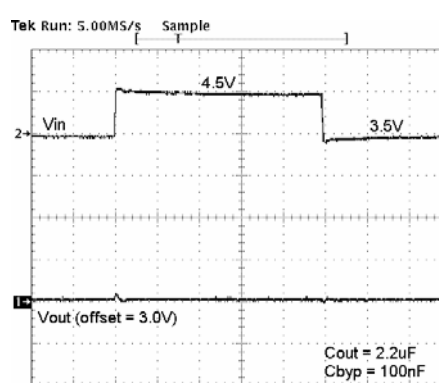

Figure 18. 3.5V - 4.5V Line Step ($t_r=1\mu s$, $C_{OUT}=2.2\mu F$, $C_{BYP}=100nF$)

Performance Information (cont'd)

Transient Characteristics (nominal conditions unless specified otherwise)

Nominal Conditions: $C_{IN} = 1\mu F$, $C_{OUT} = 2.2\mu F$, No C_{BYP} , $V_{IN} = 4.0V$, Load = 5mA

(all plots measured with 3.0V V_{OUT})

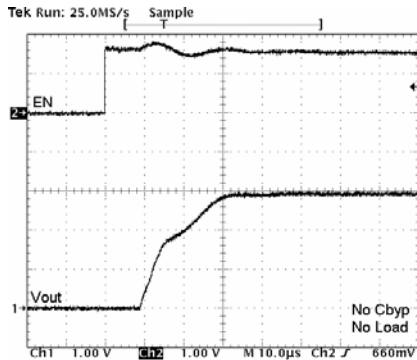

Figure 19. Enable Response (No C_{BYP} , No Load)

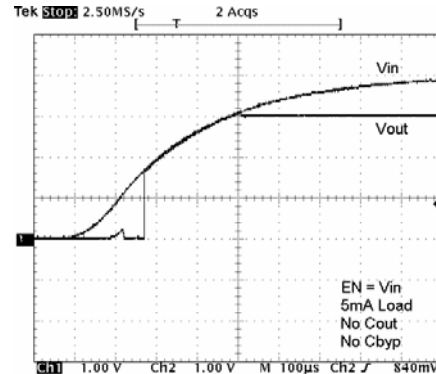

Figure 22. Power-Up ($EN=V_{IN}$, $I_{LOAD}=5mA$, No C_{OUT} , No C_{BYP})

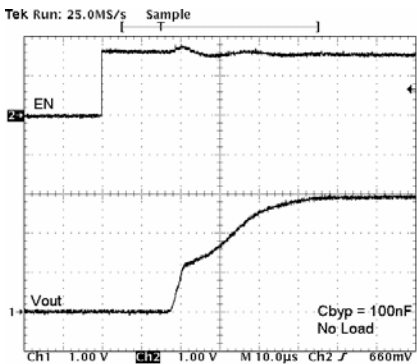

Figure 20. Enable Response ($C_{BYP}=100nF$, No Load)

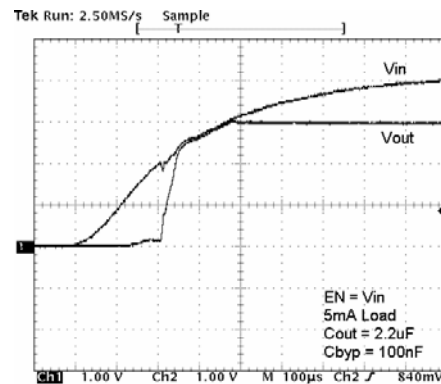

Figure 23. Power-Up ($EN=V_{IN}$, $I_{LOAD}=5mA$, $C_{OUT}=2.2\mu F$, $C_{BYP}=100nF$)

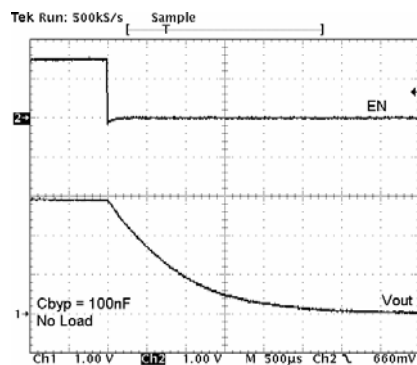

Figure 21. Disable Response ($C_{BYP}=100nF$, No Load)

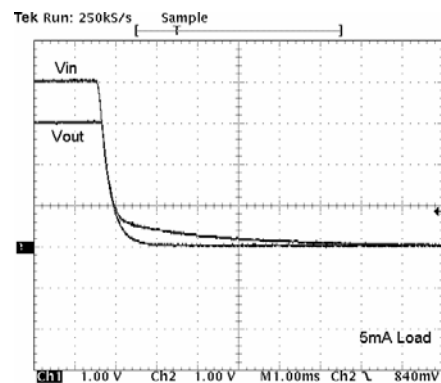

Figure 24. Power-Down ($I_{LOAD}=5mA$)

Performance Information (cont'd)

Power Supply Ripple Rejection and Noise Characteristics (nominal conditions unless specified otherwise)

Nominal Conditions: $C_{IN} = 1\mu F$, $V_{IN} = 4.0V$, PSRR measured with 50mV peak-to-peak sine wave on V_{IN} .

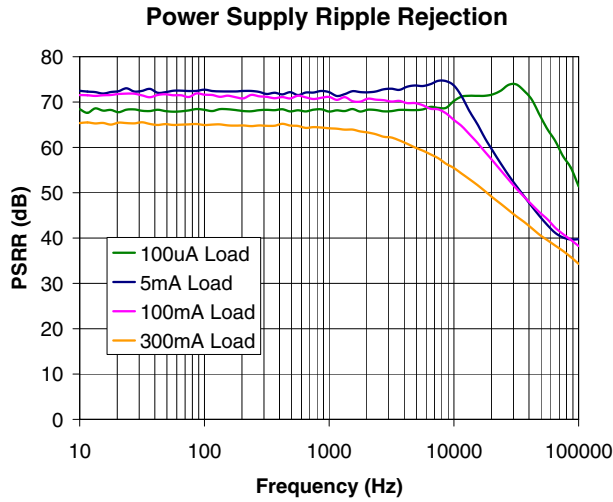

Figure 25. Power Supply Ripple Rejection
($C_{OUT}=10\mu F$, $C_{BYP}=100nF$)

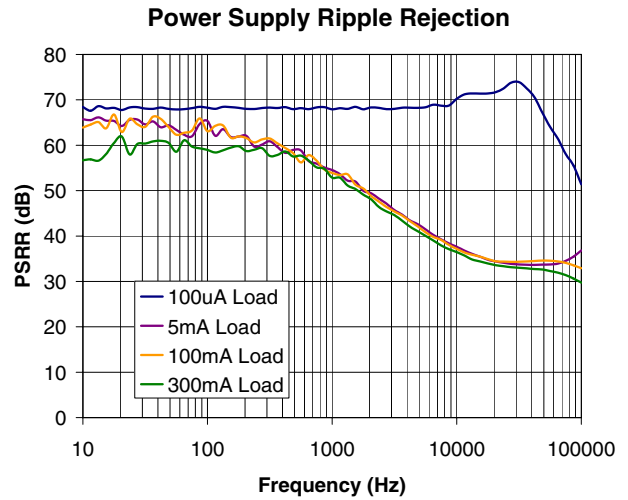

Figure 27. Power Supply Ripple Rejection
(No C_{OUT} , $C_{BYP}=100nF$)

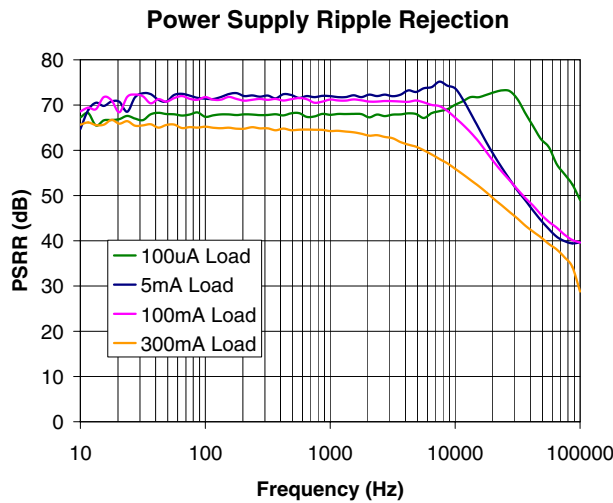

Figure 26. Power Supply Ripple Rejection
($C_{OUT}=2.2\mu F$, $C_{BYP}=100nF$)

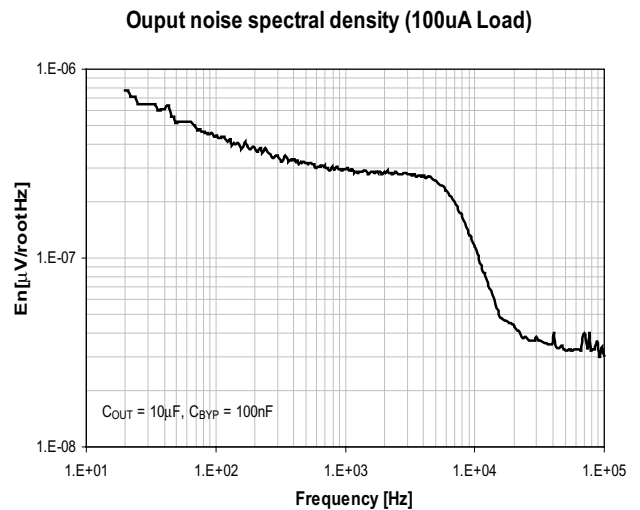

Figure 28. Output Noise Spectral Density
($I_{LOAD}=100\mu A$, $C_{OUT}=10\mu F$, $C_{BYP}=100nF$)

Performance Information (cont'd)

Typical Thermal Characteristics (nominal conditions unless specified otherwise)

Nominal Conditions: $C_{IN} = 1\mu F$, $C_{OUT} = 2.2\mu F$, No C_{BYP} , $V_{IN} = 4.0V$, Load = 5mA

(all plots measured with 3.0V V_{OUT})

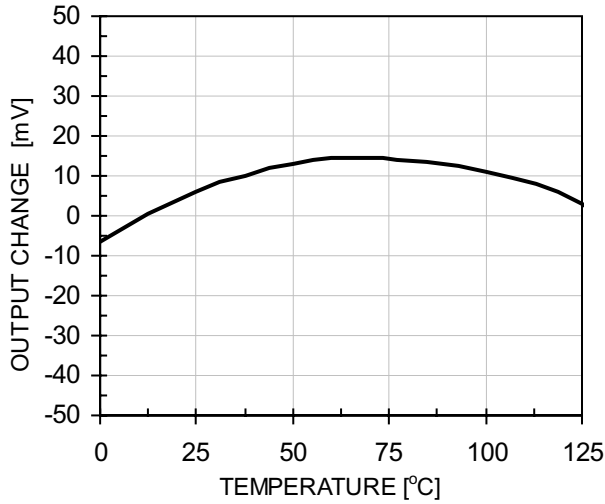

Figure 29. V_{OUT} vs. Temperature
($T_A = 0^\circ C$ to $125^\circ C$)

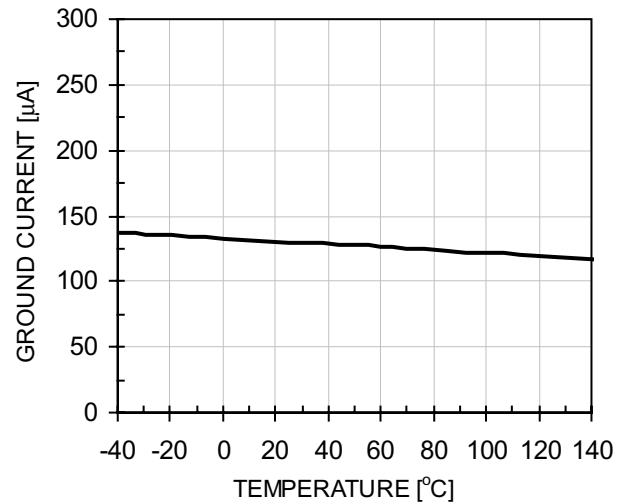

Figure 31. I_{GND} vs. Temperature
($T_A = -40^\circ C$ to $140^\circ C$)

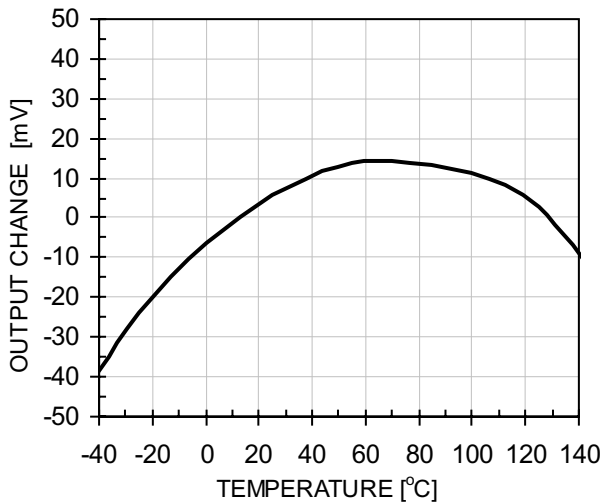
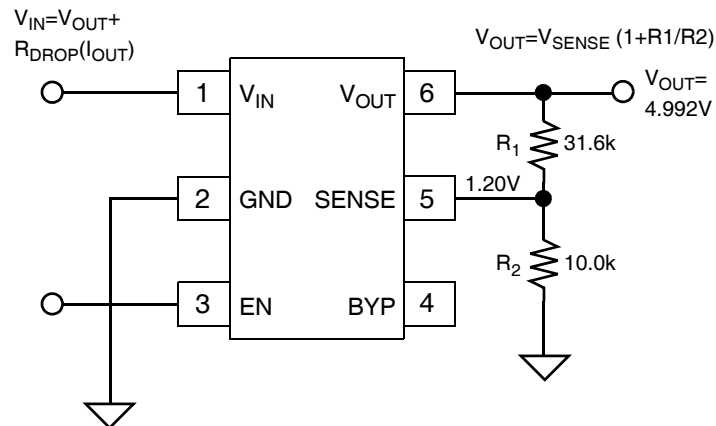

Figure 30. V_{OUT} vs. Temperature
($T_A = -40^\circ C$ to $140^\circ C$)

Application Information



For the input voltage, V_{in} minimum will depend on the output current. For example, if I_{out} is 100mA, V_{in} must be at least $4.992V = 1\text{ohm} \times 100\text{mA} = 4.992 + 0.1 = 5.092V$.

Figure 32. Adjustable Regulator Application Example

Output Compensation

Low-dropout regulator topologies use a current-carrying transistor ("pass device") that adds additional gain and phase shift to the design. It is necessary to compensate for these attributes to prevent the design from becoming unstable. The simplest way to do this is to add an output RC filter to roll off the gain. Since all regulators use an output capacitor anyway, the only component needed is a suitable resistance. Fortunately, for the usual range and types of output capacitors, this resistance can be supplied by the ESR of the caps.

For many years, capacitors have been the largest components in regulator circuits, but newer types are shrinking in size rapidly. Unfortunately, their ESRs have shrunk as well, taking them out of the range where they can perform the R function described in existing LDOs. The CM3015 is a new breed of LDO regulator that can work with these tiny low-ESR capacitors and thus permit designs that take a minimum of space.

An attribute of the LDO topology is that the pass device gain generally increases with increasing output current. This may affect output stability: a design that didn't need a capacitor now does, or a design that used a small value now needs a larger one. The CMD advantage is that this component can be selected from any capacitor family without regard to its ESR. If the circuit calls for a tiny, low-ESR capacitor, it will work just fine.

Mechanical Details

CM3015 devices are available in a 5-lead SOT23 package, a 6-lead SOT23 package and an 8-lead MSOP package. Dimensions are presented below and on the following pages.

SOT23-5 Mechanical Specifications

The dimensions for the 3-lead SOT23 package are presented below.

PACKAGE DIMENSIONS				
Package	SOT23-5			
JEDEC No.	MO-178 (Var. AA)			
Pins/Leads	5			
Dimensions	Millimeters		Inches	
	Min	Max	Min	Max
A	--	1.45	--	0.0571
A1	0.00	0.15	0.0000	0.0059
b	0.30	0.50	0.0118	0.0197
c	0.08	0.22	0.0031	0.0087
D	2.75	3.05	0.1083	0.1201
E	2.60	3.00	0.1024	0.1181
E1	1.45	1.75	0.0571	0.0689
e	0.95 BSC		0.0374 BSC	
e1	1.90 BSC		0.0748 BSC	
L	0.30	0.60	0.0118	0.0236
L1	0.60 REF		0.0236 REF	
# per tape and reel	3000 pieces			
Controlling dimension: millimeters				

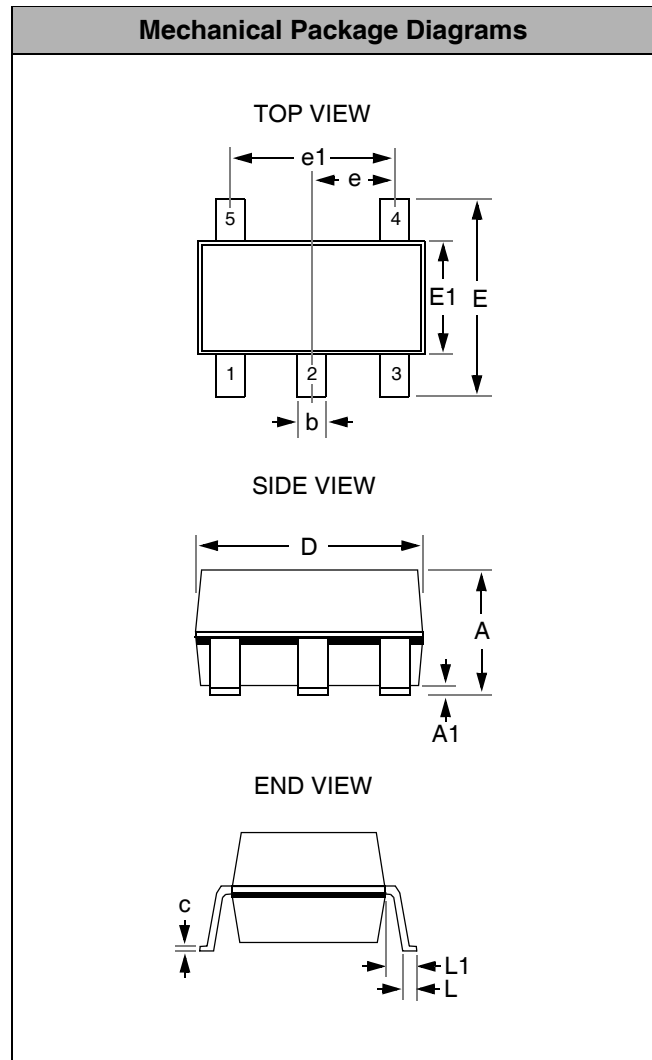

Package Dimensions for SOT23-5.

Mechanical Details (cont'd)

SOT23-6 Mechanical Specifications

The dimensions for the 6-lead SOT23 package are presented below.

PACKAGE DIMENSIONS				
Package	SOT23-6			
JEDEC No.	MO-178 (Var. AB)			
Pins/Leads	6			
Dimensions	Millimeters		Inches	
	Min	Max	Min	Max
A	--	1.45	--	0.0571
A1	0.00	0.15	0.0000	0.0059
b	0.30	0.50	0.0118	0.0197
c	0.08	0.22	0.0031	0.0087
D	2.75	3.05	0.1083	0.1201
E	2.60	3.00	0.1024	0.1181
E1	1.45	1.75	0.0571	0.0689
e	0.95 BSC		0.0374 BSC	
e1	1.90 BSC		0.0748 BSC	
L	0.30	0.60	0.0118	0.0236
L1	0.60 REF		0.0236REF	
# per tape and reel	3000 pieces			
Controlling dimension: millimeters				

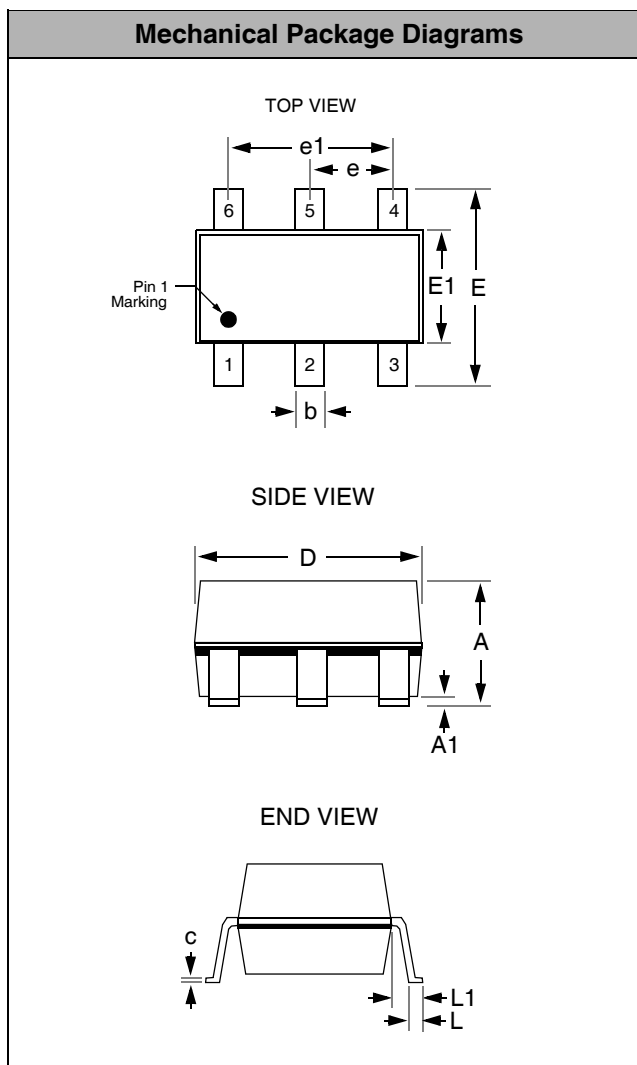

Package Dimensions for SOT23-6.

Mechanical Details (cont'd)

MSOP-8 Mechanical Specifications:

The dimensions for the 6-lead SOT23 package are presented below.

PACKAGE DIMENSIONS				
Package	MSOP			
Pins	8			
Dimensions	Millimeters		Inches	
	Min	Max	Min	Max
A	0.87	1.17	0.034	0.046
A1	0.05	0.25	0.002	0.010
B	0.30 (typ)		0.012 (typ)	
C	0.18		0.007	
D	2.90	3.10	0.114	0.122
E	2.90	3.10	0.114	0.122
e	0.65 BSC		0.025 BSC	
H	4.78	4.98	0.188	0.196
L	0.52	0.54	0.017	0.025
# per tube	80 pieces*			
# per tape and reel	4000 pieces			
Controlling dimension: inches				

* This is an approximate amount which may vary.

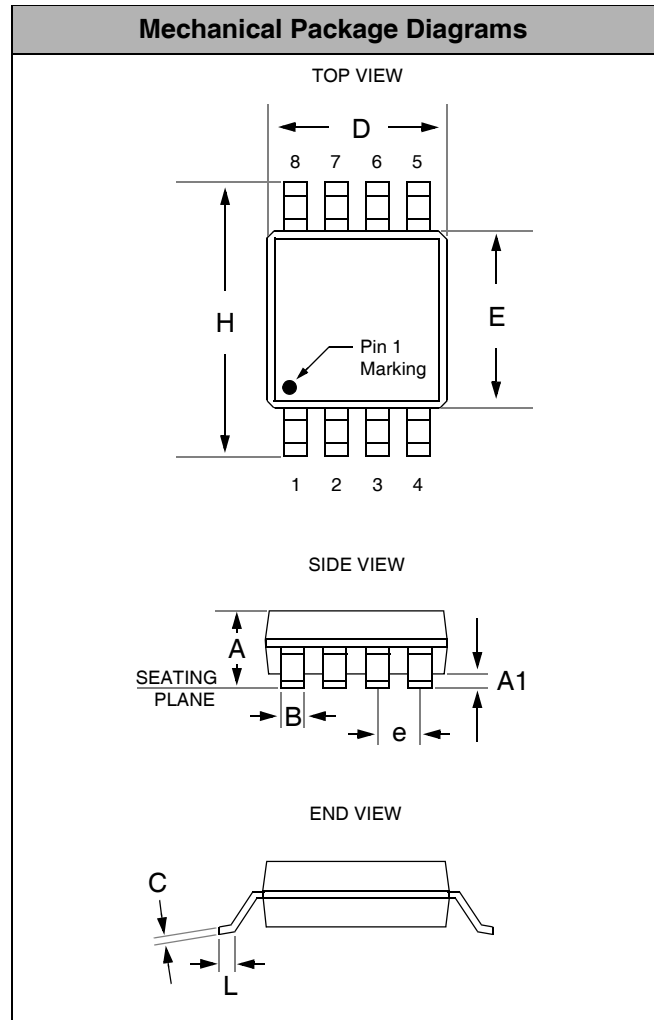

Package Dimensions for MSOP-8