

# MSKW2000 Series

## 5W 2:1 Wide Input Range SMD, Single & Dual Output DC/DC Converters

### Key Features



- Efficiency up to 85%
- High Power Density
- 2:1 Input Range
- I/O Isolation 1500VDC
- Remote on/off Control
- SMT Technology
- Industry Standard Pinout
- Short Circuit Protection
- EMI Complies With EN55022 Class A
- MTBF > 1,000,000 Hours

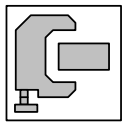

Low Profile

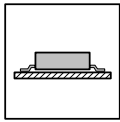

SMD

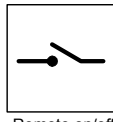

Remote on/off

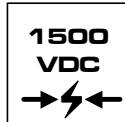

I/O Isolation



EN55022

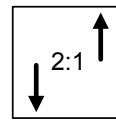

Wide Range

Minmax's MSKW2000-Series are in "gull-wing" SMT package. The series consists of 21 models with input voltage ranges of 9–18VDC, 18–36VDC and 36–75VDC which provide precisely regulated output voltages of 3.3V, 5V, 12V, 15V,  $\pm 5V$ ,  $\pm 12V$  and  $\pm 15VDC$ .

The  $-40^{\circ}C$  to  $+71^{\circ}C$  operating temperature range makes it ideal for data communication equipments, mobile battery driven equipments, distributed power systems, telecommunication equipments, mixed analog/digital subsystems, process/machine control equipments, computer peripheral systems and industrial robot systems.

The modules have a maximum power rating of 5W and a typical full-load efficiency of 85%, continuous short circuit, Remote on/off EN55022 Class A conducted noise compliance minimize design-in time, cost and eliminate the need for external filtering.

### Absolute Maximum Ratings

Parameter	Min.	Max.	Unit	
Input Surge Voltage (1000 mS)	12VDC Input Models	-0.7	25	VDC
	24VDC Input Models	-0.7	50	VDC
	48VDC Input Models	-0.7	100	VDC
Lead Temperature (1.5mm from case for 10 Sec.)	---	260	$^{\circ}C$	
Internal Power Dissipation	---	2,500	mW	

Exceeding the absolute maximum ratings of the unit could cause damage. These are not continuous operating ratings.

### Environmental Specifications

Parameter	Conditions	Min.	Max.	Unit
Operating Temperature	Ambient	-40	+71	$^{\circ}C$
Operating Temperature	Case	-40	+90	$^{\circ}C$
Storage Temperature		-40	+125	$^{\circ}C$
Humidity		---	95	%
Cooling	Free-Air Convection			
Conducted EMI	EN55022 Class A			

Leadfree Reflow Solder Process as per IPC/JEDEC J-STD-020C peak temp. 245C/10 sec.

## Model Selection Guide

Model Number	Input Voltage	Output Voltage	Output Current		Input Current		Reflected Ripple Current	Efficiency
			Max.	Min.	@Max. Load	@No Load		@Max. Load
	VDC	VDC	mA	mA	mA (Typ.)	mA (Typ.)	mA (Typ.)	% (Typ.)
MSKW2021	12 (9 ~ 18)	3.3	1200	120	434	45	25	76
MSKW2022		5	1000	100	521			80
MSKW2023		12	417	41.7	502			83
MSKW2024		15	333	33.3	502			83
MSKW2025		±5	±500	±50	521			80
MSKW2026		±12	±208	±20.8	501			83
MSKW2027		±15	±167	±16.7	503			83
MSKW2031	24 (18 ~ 36)	3.3	1200	120	212	15	15	78
MSKW2032		5	1000	100	254			82
MSKW2033		12	417	41.7	245			85
MSKW2034		15	333	33.3	245			85
MSKW2035		±5	±500	±50	254			82
MSKW2036		±12	±208	±20.8	245			85
MSKW2037		±15	±167	±16.7	246			85
MSKW2041	48 (36 ~ 75)	3.3	1200	120	106	6	10	78
MSKW2042		5	1000	100	127			82
MSKW2043		12	417	41.7	123			85
MSKW2044		15	333	33.3	122			85
MSKW2045		±5	±500	±50	127			82
MSKW2046		±12	±208	±20.8	122			85
MSKW2047		±15	±167	±16.7	123			85

## Capacitive Load

Models by Vout	3.3V	5V	12V	15V	±5V #	±12V #	±15V #	Unit
Maximum Capacitive Load	680	680	680	680	100	100	100	uF

# For each output

## Input Fuse Selection Guide

12V Input Models	24V Input Models	48V Input Models
1500mA Slow – Blow Type	700mA Slow – Blow Type	350mA Slow – Blow Type

## Input Specifications

Parameter	Model	Min.	Typ.	Max.	Unit
Start Voltage	12V Input Models	7.5	8	9	VDC
	24V Input Models	14	16	18	
	48V Input Models	30	33	36	
Under Voltage Shutdown	12V Input Models	6.5	7	8	
	24V Input Models	13	15	17	
	48V Input Models	28	31	34	
Reverse Polarity Input Current	All Models	---	---	1	A
Short Circuit Input Power		---	1000	3000	mW
Input Filter		Pi Filter			

## Output Specifications

Parameter	Conditions	Min.	Typ.	Max.	Unit
Output Voltage Accuracy		---	$\pm 0.5$	$\pm 1.0$	%
Output Voltage Balance	Dual Output, Balance Loads	---	$\pm 0.5$	$\pm 2.0$	%
Line Regulation	$V_{in} = \text{Min. to Max.}$	---	$\pm 0.1$	$\pm 0.3$	%
Load Regulation	$I_o = 20\% \text{ to } 100\%$	---	$\pm 0.3$	$\pm 1.0$	%
Ripple & Noise (20MHz)		---	50	85	mV P-P
Ripple & Noise (20MHz)	Over Line, Load & Temp	---	---	100	mV P-P
Ripple & Noise (20MHz)		---	---	15	mV rms.
Over Power Protection		115	140	165	%
Transient Recovery Time	25% Load Step Change	---	250	500	$\mu\text{s}$
Transient Response Deviation		---	$\pm 2$	$\pm 6$	%
Temperature Coefficient		---	$\pm 0.01$	$\pm 0.02$	%/°C
Output Short Circuit	Continuous				

## General Specifications

Parameter	Conditions	Min.	Typ.	Max.	Unit
Isolation Voltage Rated	60 Seconds	1500	---	---	VDC
Isolation Voltage Test	Flash Tested for 1 Second	1650	---	---	VDC
Isolation Resistance	500VDC	1000	---	---	M $\Omega$
Isolation Capacitance	100KHz, 1V	---	650	750	pF
Switching Frequency		200	260	350	KHz
MTBF	MIL-HDBK-217F @ 25°C, Ground Benign	1000	---	---	K Hours
Moisture Sensitivity Level (MSL) TEMPERATURE	IPC/JEDEC J-STD-20	LEVEL 2			

## Remote On/Off Control

Parameter	Conditions	Min.	Typ.	Max.	Unit
Supply On	2.5 to 5.5 VDC or Open Circuit				
Supply off		-0.7	---	0.8	VDC
Device Standby Input Current		---	---	10	mA
Control Input Current ( on )	$V_{in} = \text{Min. to Max.}$	---	---	-200	$\mu\text{A}$
Control Input Current ( off )	$V_{in} = \text{Min. to Max.}$	---	---	-300	$\mu\text{A}$
Control Common	Referenced to Negative Input				

### Notes:

1. Specifications typical at  $T_a = +25^\circ\text{C}$ , resistive load, nominal input voltage, rated output current unless otherwise noted.
2. Transient recovery time is measured to within 1% error band for a step change in output load of 75% to 100%.
3. Ripple & Noise measurement bandwidth is 0-20 MHz.
4. These power converters require a minimum output loading to maintain specified regulation.
5. Operation under no-load conditions will not damage these modules; however, they may not meet all specifications listed.
6. All DC/DC converters should be externally fused at the front end for protection
7. Other input and output voltage may be available, please contact factory.
8. Specifications subject to change without notice.

## Block Diagram

### Single Output

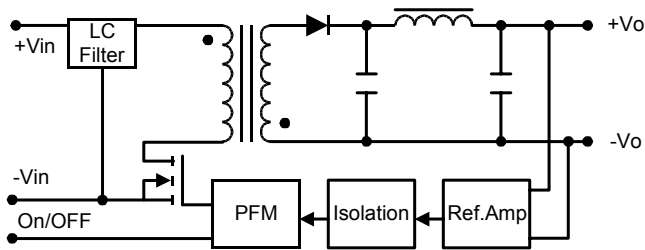

### Dual Output

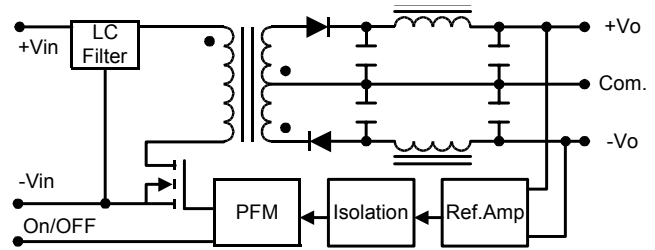

## Input Voltage Transient Rating

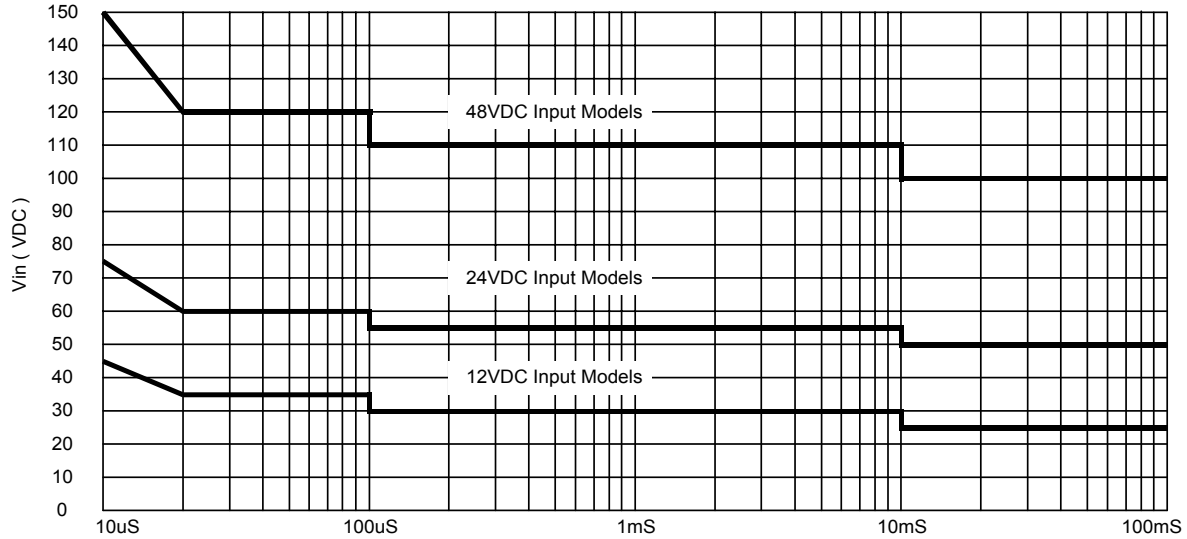

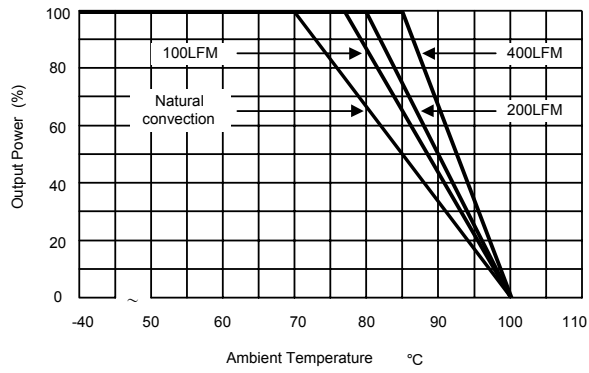

**Derating Curve**

## Test Configurations

### Input Reflected-Ripple Current Test Setup

Input reflected-ripple current is measured with an inductor  $L_{in}$  (4.7uH) and  $C_{in}$  (220uF, ESR < 1.0Ω at 100 KHz) to simulate source impedance.

Capacitor  $C_{in}$ , offsets possible battery impedance.

Current ripple is measured at the input terminals of the module, measurement bandwidth is 0–500 KHz.

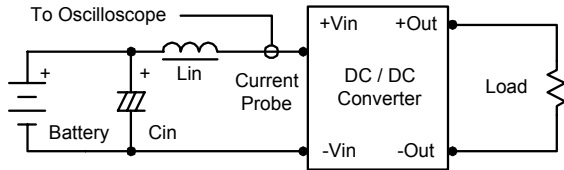

### Peak-to-Peak Output Noise Measurement Test

Use a  $C_{out}$  0.47uF ceramic capacitor.

Scope measurement should be made by using a BNC socket, measurement bandwidth is 0–20 MHz. Position the load between 50 mm and 75 mm from the DC/DC Converter.

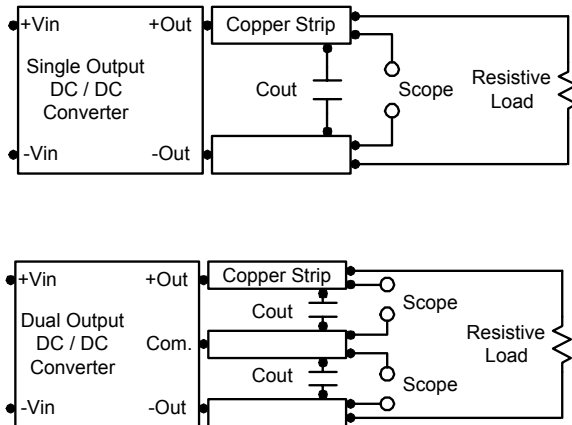

## Design & Feature Considerations

### Input Source / Remote On/Off

Positive logic remote on/off turns the module on during a logic high voltage on the remote on/off pin, and off during a logic low.

To turn the power module on and off, the user must supply a switch to control the voltage between the on/off terminal and the  $-V_{in}$  terminal.

The switch can be an open collector or equivalent.

A logic low is  $-0.7V$  to  $0.8V$ .

A logic high is  $2.5V$  to  $5.5V$ .

The maximum sink current of the switch at on/off terminal during a logic low is 300 uA.

The maximum sink current of the switch at on/off terminal =  $2.5$  to  $5.5V$  is 200uA or open.

### Maximum Capacitive Load

The MSKW2000 series has limitation of maximum connected capacitance at the output.

The power module may be operated in current limiting mode during start-up, affecting the ramp-up and the startup time.

For optimum performance we recommend 100uF maximum capacitive load for dual outputs and 680uF capacitive load for single outputs.

The maximum capacitance can be found in the data sheet.

### Overcurrent Protection

To provide protection in a fault (output overload) condition, the unit is equipped with internal current limiting circuitry and can endure current limiting for an unlimited duration. At the point of current-limit inception, the unit shifts from voltage control to current control. The unit operates normally once the output current is brought back into its specified range.

### Input Source Impedance

The power module should be connected to a low ac-impedance input source. Highly inductive source impedances can affect the stability of the power module.

In applications where power is supplied over long lines and output loading is high, it may be necessary to use a capacitor at the input to ensure startup.

Capacitor mounted close to the power module helps ensure stability of the unit, it is recommended to use a good quality low Equivalent Series Resistance (ESR < 1.0Ω at 100 KHz) capacitor of a 3.3uF for the 12V input devices and a 2.2uF for the 24V and 48V devices.

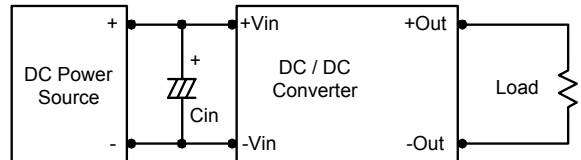

## Output Ripple Reduction

A good quality low ESR capacitor placed as close as practicable across the load will give the best ripple and noise performance.

To reduce output ripple, it is recommended to use 3.3 $\mu$ F capacitors at the output.

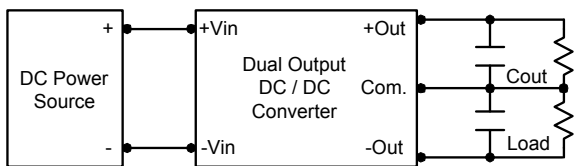
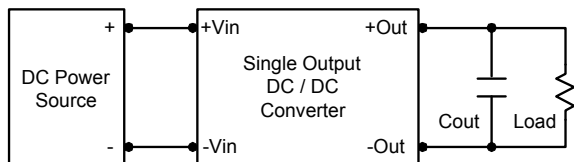

## Thermal Considerations

Many conditions affect the thermal performance of the power module, such as orientation, airflow over the module and board spacing. To avoid exceeding the maximum temperature rating of the components inside the power module, the case temperature must be kept below 90°C.

The derating curves are determined from measurements obtained in an experimental apparatus.

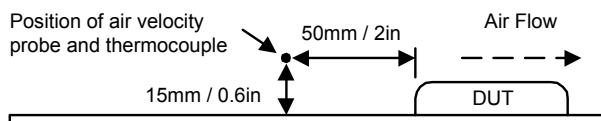

## Mechanical Dimensions

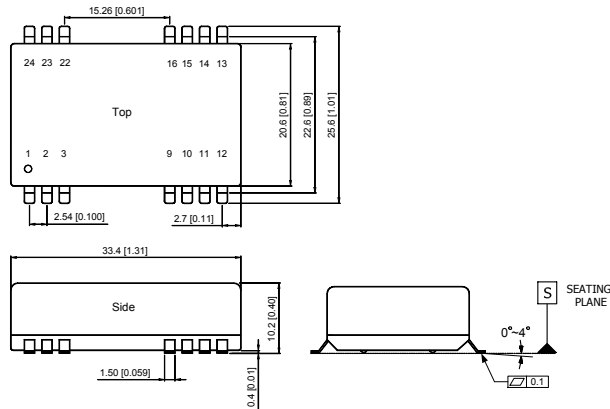

## Connecting Pin Patterns

Top View ( 2.54 mm / 0.1 inch grids )

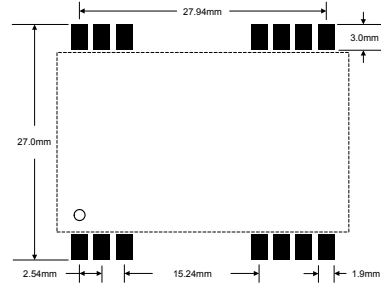

Tolerance	Millimeters	Inches
	$X.X \pm 0.25$	$X.XX \pm 0.01$
	$X.XX \pm 0.13$	$X.XXX \pm 0.005$
Pin	$\pm 0.05$	$\pm 0.002$

## Pin Connections

Pin	Single Output	Dual Output
1	Remote On/Off	Remote On/Off
2	-Vin	-Vin
3	-Vin	-Vin
9	NC	Common
10	NC	NC
11	NC	-Vout
12	NC	NC
13	NC	NC
14	+Vout	+Vout
15	NC	NC
16	-Vout	Common
22	+Vin	+Vin
23	+Vin	+Vin
24	NC	NC

NC: No Connection

## Physical Characteristics

Case Size	:	33.4x20.6x10.2 mm 1.31x0.81x0.40 inches
Case Material	:	Non-Conductive Black Plastic
Weight	:	14g
Flammability	:	UL94V-0