



Elektrische Eigenschaften / Electrical properties

Höchstzulässige Werte / Maximum rated values

Periodische Vorwärts- und Rückwärts-Spitzenpersperrspannung repetitive peak forward off-state and reverse voltages	$T_{vj} = -40^{\circ}\text{C} \dots T_{vj\text{max}}$	$V_{\text{DRM}}, V_{\text{RRM}}$	2000 2400	2200 2600	V V ¹⁾
Vorwärts-Stoßspitzenpersperrspannung non-repetitive peak forward off-state voltage	$T_{vj} = -40^{\circ}\text{C} \dots T_{vj\text{max}}$	V_{DSM}	2000 2400	2200 2600	V V
Rückwärts-Stoßspitzenpersperrspannung non-repetitive peak reverse voltage	$T_{vj} = +25^{\circ}\text{C} \dots T_{vj\text{max}}$	V_{RSM}	2100 2500	2300 2700	V V
Durchlaßstrom-Grenzeffektivwert RMSM on-state current		I_{TRSMMSM}		1800	A
Dauergrenzstrom average on-state current	$T_{\text{C}} = 85^{\circ}\text{C}$ $T_{\text{C}} = 60^{\circ}\text{C}$	I_{TAVM}		829 1145	A A
Stoßstrom-Grenzwert surge current	$T_{vj} = 25^{\circ}\text{C}, t_p = 10\text{ms}$ $T_{vj} = T_{vj\text{max}}, t_p = 10\text{ms}$	I_{TSM}		17500 15500	A A
Grenzlastintegral I^2t -value	$T_{vj} = 25^{\circ}\text{C}, t_p = 10\text{ms}$ $T_{vj} = T_{vj\text{max}}, t_p = 10\text{ms}$	I^2t		1531 1201	$\text{A}^2\text{s} \cdot 10^3$ $\text{A}^2\text{s} \cdot 10^5$
Kritische Stromsteilheit critical rate of rise of on-state current	DIN IEC 747-6 $f=50\text{Hz}, v_L = 10\text{V}, i_{\text{GM}} = 1\text{A}$ $di_{\text{G}}/dt = 1\text{A}/\mu\text{s}$	$(di_{\text{T}}/dt)_{\text{cr}}$		50	$\text{A}/\mu\text{s}$
Kritische Spannungssteilheit critical rate of rise of off-state voltage	$T_{vj} = T_{vj\text{max}}, v_{\text{D}} = 0,67 V_{\text{DRM}}$ 5.Kennbuchstabe / 5th letter F	$(dv_{\text{D}}/dt)_{\text{cr}}$		1000	$\text{V}/\mu\text{s}$

Charakteristische Werte / Characteristic values

Durchlaßspannung on-state voltage	$T_{vj} = T_{vj\text{max}}, i_{\text{T}} = 1800\text{A}$	v_{T}	max.	1,78	V
Schleusenspannung threshold voltage	$T_{vj} = T_{vj\text{max}}$	$V_{\text{T(TO)}}$		0,95	V
Ersatzwiderstand slope resistance	$T_{vj} = T_{vj\text{max}}$	r_{T}		0,425	$\text{m}\Omega$
Durchlaßkennlinie on-state voltage $v_{\text{T}} = A + B \times i_{\text{T}} + C \times \ln(i_{\text{T}} + 1) + D \times \sqrt{i_{\text{T}}}$	$T_{vj} = T_{vj\text{max}}$	A= 1,0069 B= 3,381E-04 C=-0,02723 D= 8,5423E-03			
Zündstrom gate trigger current	$T_{vj} = 25^{\circ}\text{C}, v_{\text{D}} = 6\text{V}$	I_{GT}	max.	250	mA
Zündspannung gate trigger voltage	$T_{vj} = 25^{\circ}\text{C}, v_{\text{D}} = 6\text{V}$	V_{GT}	max.	1,5	V
Nicht zündener Steuerstrom gate non-trigger current	$T_{vj} = T_{vj\text{max}}, v_{\text{D}} = 6\text{V}$ $T_{vj} = T_{vj\text{max}}, v_{\text{D}} = 0,5 V_{\text{DRM}}$	I_{GD}	max. max.	10 5	mA mA
Nicht zündene Steuerspannung gate non-trigger voltage	$T_{vj} = T_{vj\text{max}}, v_{\text{D}} = 0,5 V_{\text{DRM}}$	V_{GD}	max.	0,2	mV
Haltestrom holding current	$T_{vj} = 25^{\circ}\text{C}, v_{\text{D}} = 6\text{V}, R_{\text{A}} = 5\Omega$	I_{H}	max.	600	mA
Einraststrom latching current	$T_{vj} = 25^{\circ}\text{C}, v_{\text{D}} = 6\text{V}, R_{\text{GK5}} = 10\Omega$ $i_{\text{GM}} = 1\text{A}, di_{\text{G}}/dt = 1\text{A}/\mu\text{s}$ $t_{\text{G}} = 20\mu\text{s}$	I_{L}	max.	2000	mA
Vorwärts- und Rückwärts-Sperrstrom forward off-state and reverse currents	$T_{vj} = T_{vj\text{max}}$ $v_{\text{D}} = V_{\text{DRM}}, v_{\text{R}} = V_{\text{RRM}}$	$i_{\text{D}}, i_{\text{R}}$	max.	100	mA
Zündverzug gate controlled delay time	DIN IEC 747-6 $T_{vj} = 25^{\circ}\text{C}$ $i_{\text{GM}} = 1\text{A}, di_{\text{G}}/dt = 1\text{A}/\mu\text{s}$	t_{gd}	max.	4	μs

Netz-Thyristor
Phase Control Thyristor

T 829 N 20 ...26

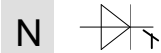

Elektrische Eigenschaften / Electrical properties

Charakteristische Werte / Characteristic values

Freiwerdezeit circuit commutated turn-off time	$T_{vj} = T_{vj\ max}$, $i_{TM} = I_{TAVM}$ $V_{RM} = 100V$, $v_{DM} = 0,67 V_{DRM}$ $dv_D/dt = 20 V/\mu s$, $-di_T/dt = 10 A/\mu s$ 4. Kennbuchstabe / 4th letter O	t_q	typ. 350	μs
---	--	-------	----------	---------

Thermische Eigenschaften / Thermal properties

Innerer Wärmewiderstand thermal resistance, junction to case	Kühlfläche / cooling surface beidseitig / two-sided, $\theta = 180^\circ \sin$ beidseitig / two-sided, DC Anode / anode, $\theta = 180^\circ \sin$ Anode / anode, DC Kathode / cathode, $\theta = 180^\circ \sin$ Kathode / cathode, DC	R_{thJC}	max. 0,0265 max. 0,0240 max. 0,0445 max. 0,0420 max. 0,0585 max. 0,0560	$^\circ C/W$ $^\circ C/W$ $^\circ C/W$ $^\circ C/W$ $^\circ C/W$ $^\circ C/W$
Übergangs- Wärmewiderstand thermal resistance, case to heatsink	Kühlfläche / cooling surface beidseitig / two-sided einseitig / single-sided	R_{thCK}	max. 0,0035 max. 0,0070	$^\circ C/W$ $^\circ C/W$
Höchstzulässige Sperrschichttemperatur max. junction temperature		$T_{vj\ max}$	125	$^\circ C$
Betriebstemperatur operating temperature		$T_{c\ op}$	-40...125	$^\circ C$
Lagertemperatur storage temperature		T_{stg}	-40...140	$^\circ C$

Mechanische Eigenschaften / Mechanical properties

Gehäuse, siehe Anlage case, see appendix			Seite 3 page 3	
Si-Element mit Druckkontakt Si-pellet with pressure contact				
Anpreßkraft clamping force		F	12 ...24	kN
Gewicht weight		G	typ. 540	g
Kriechstrecke creepage distance			32	mm
Feuchteklasse humidity classification	DIN 40040		C	
Schwingfestigkeit vibration resistance	f = 50Hz		50	m/s ²

Mit dieser technischen Information werden Halbleiterbauelemente spezifiziert, jedoch keine Eigenschaften zugesichert. Sie gilt in Verbindung mit den zugehörigen Technischen Erläuterungen./ The technical information specifies semiconductor devices but promises no characteristics. It is valid in combination with the belonging technical notes.

Netz-Thyristor
Phase Control Thyristor

T 829 N 20 ...26

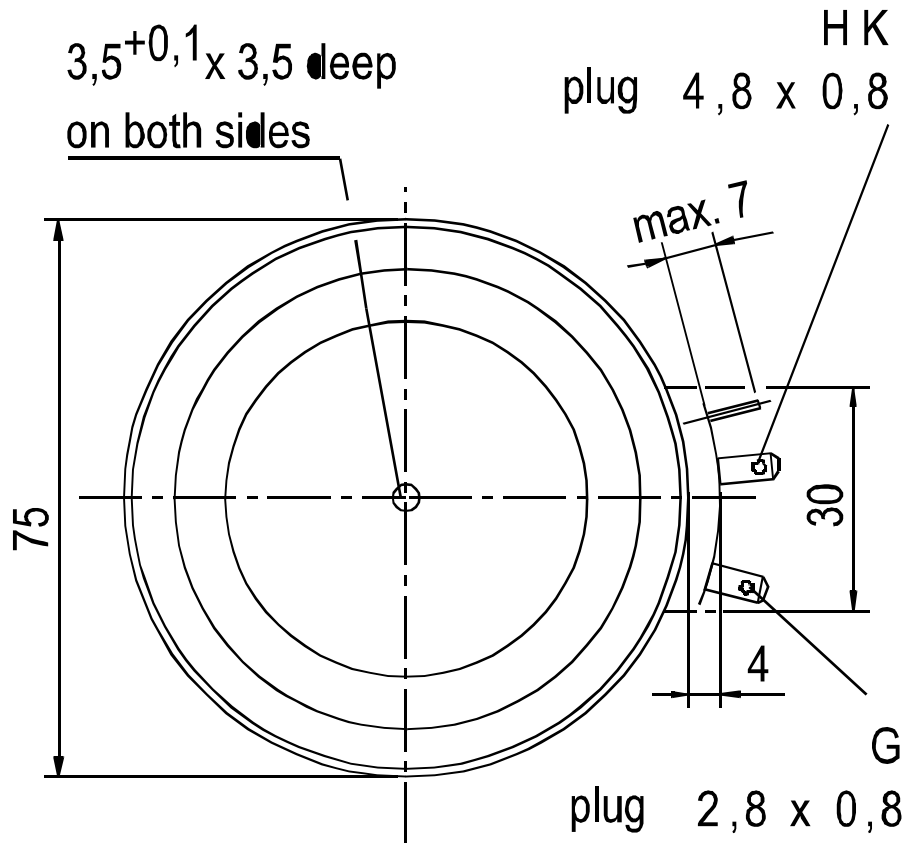
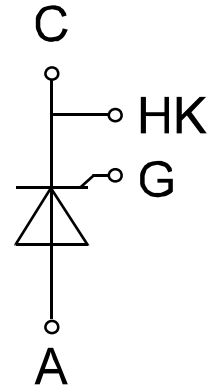
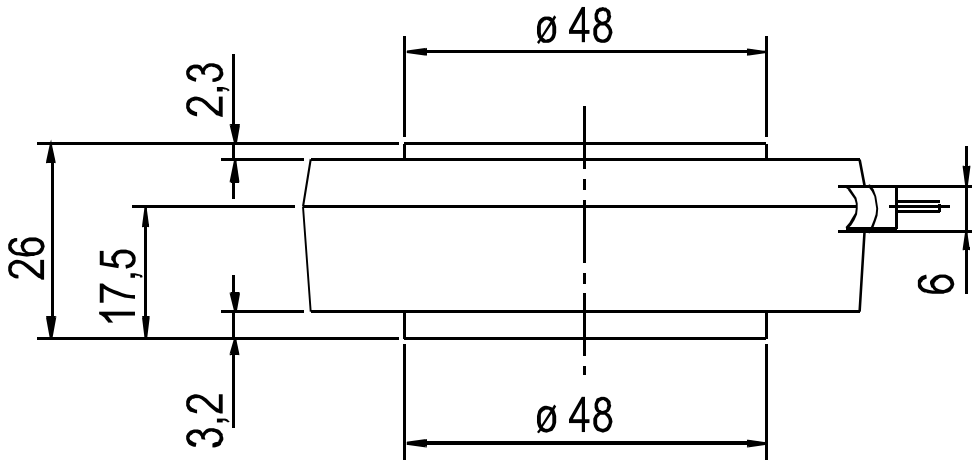

Kühlung cooling	Analytische Elemente des transienten Wärmewiderstandes Z_{thJC} für DC Analytical elements of transient thermal impedance Z_{thJC} for DC							
	Pos.n	1	2	3	4	5	6	7
beidseitig two-sided	R_{thn} [°C/W]	0,001230	0,002720	0,003330	0,008230	0,008490		
	τ_n [s]	0,001460	0,005630	0,060900	0,239000	1,240000		
anodenseitig anode-sided	R_{thn} [°C/W]	0,001200	0,002720	0,003580	0,009650	0,004650		
	τ_n [s]	0,001440	0,005470	0,061100	0,276000	4,300000		
kathodenseitig cathode-sided	R_{thn} [°C/W]	0,001280	0,002910	0,009550	0,003560	0,038700		
	τ_n [s]	0,001470	0,006130	0,134000	0,741000	8,810000		
Analytische Funktion / analytical function : $Z_{thJC} = \sum_{n=1}^{n_{max}} R_{thn} (1 - EXP (- t / \tau_n))$								

Netz-Thyristor
Phase Control Thyristor

T 829 N 20 ...26

N

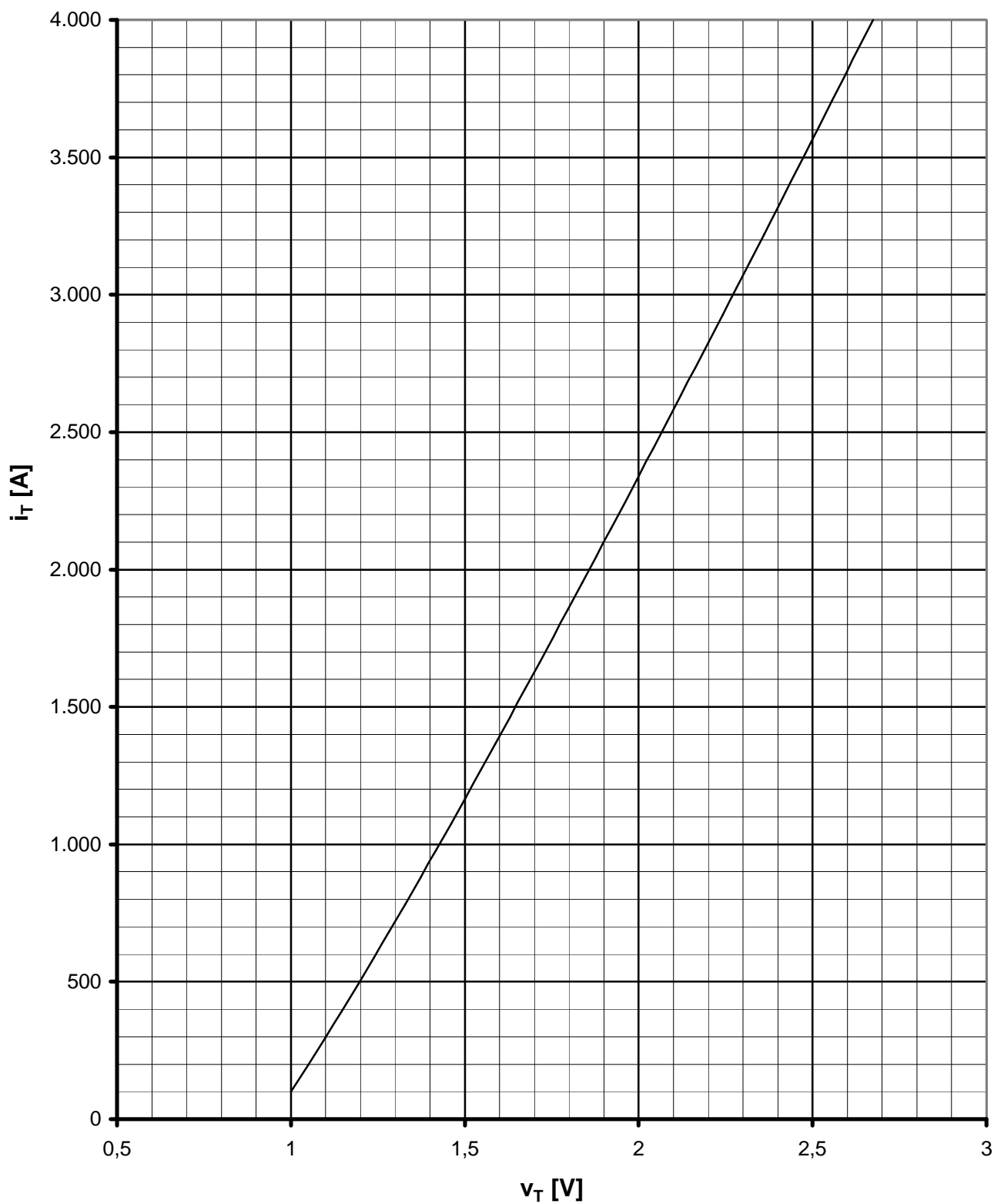

Grenzdurchlaßkennlinie / Limiting On-state characteristics $i_T = f(v_T)$
 $T_{vj} = T_{vj} \text{ max}$

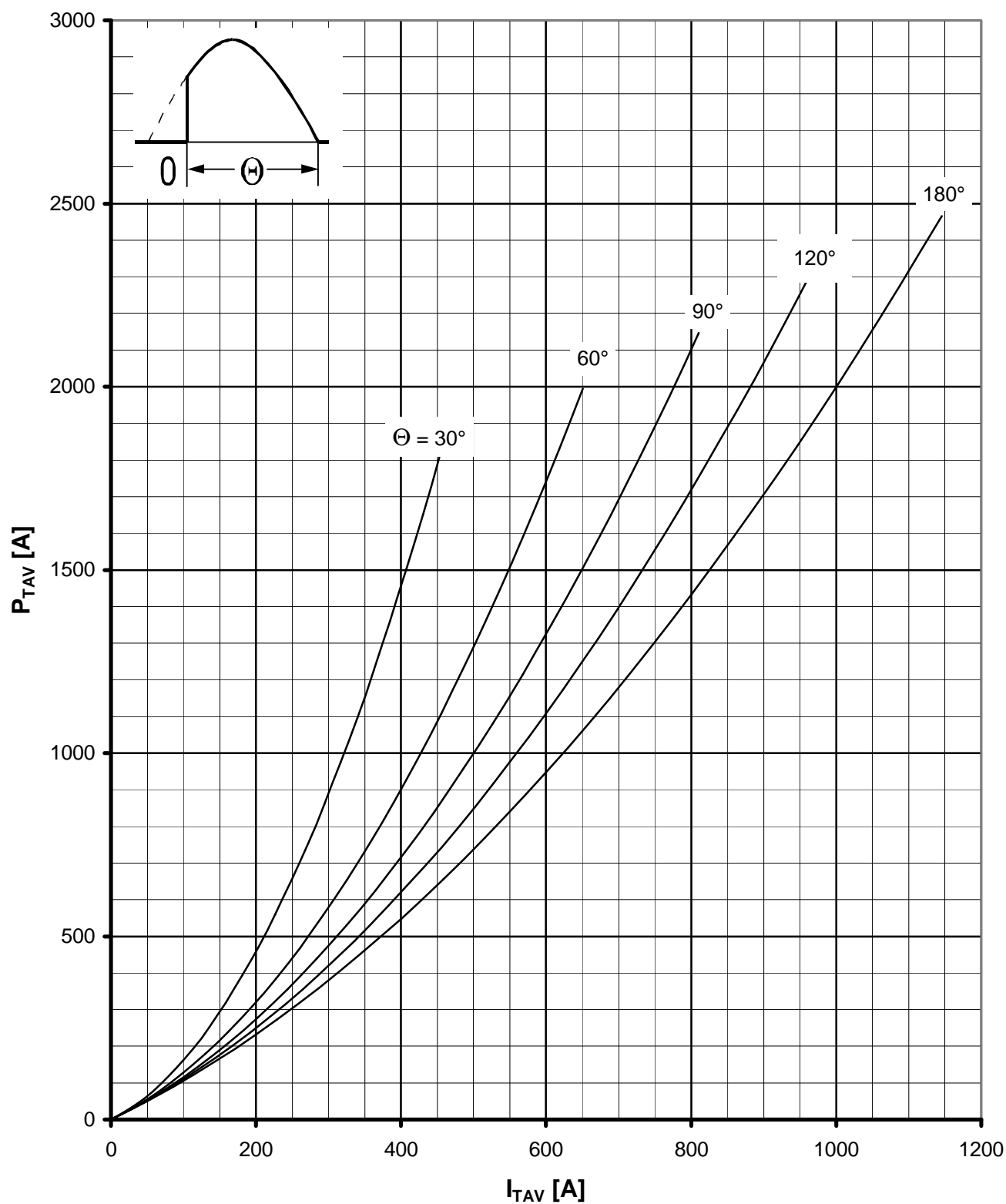

Durchlaßverlustleistung / On-state power loss $P_{TAV} = f(I_{TAV})$
 Parameter: Stromflußwinkel Θ / current conduction angle Θ

Netz-Thyristor
Phase Control Thyristor

T 829 N 20 ...26

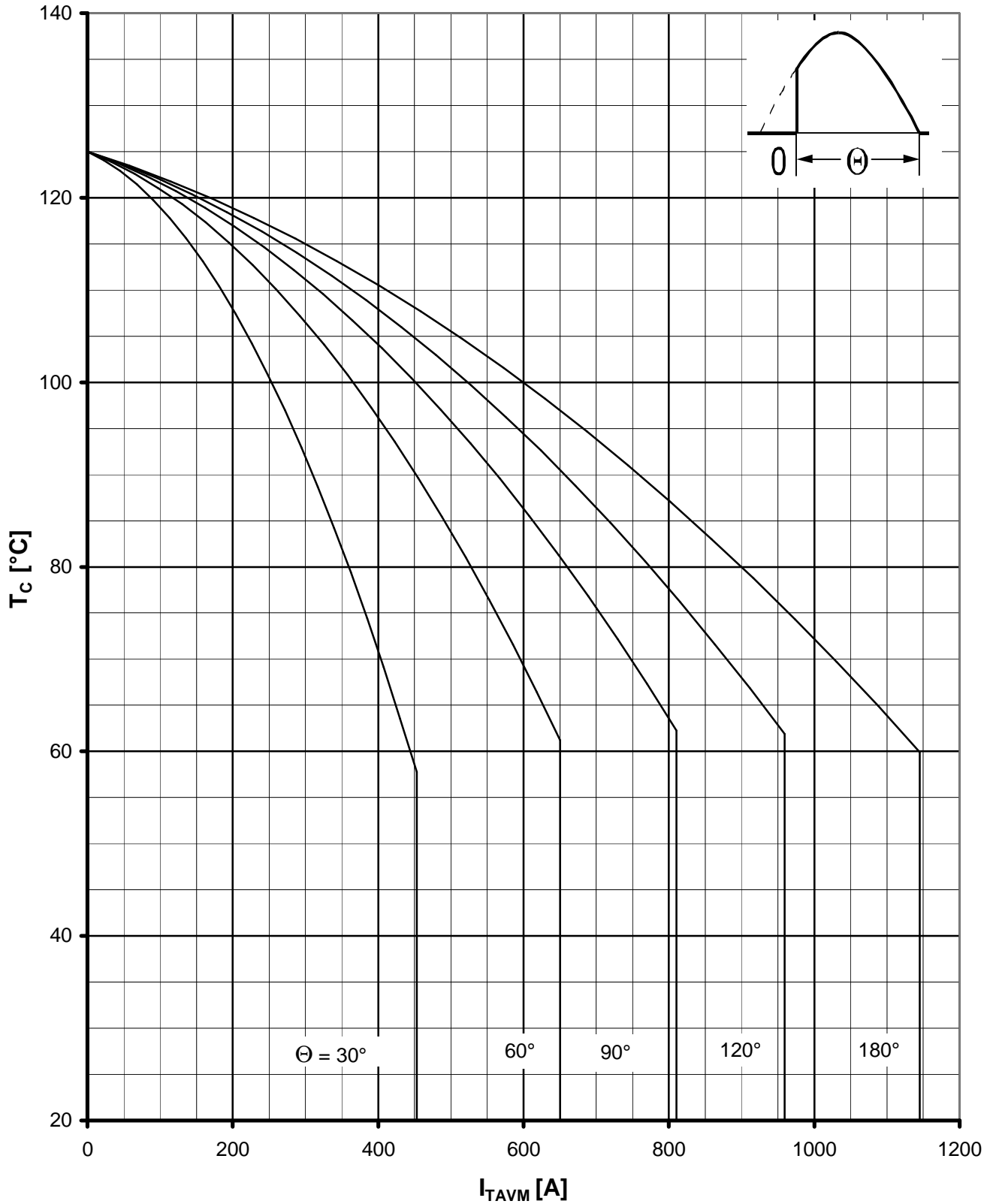

Höchstzulässige Gehäusetemperatur / Maximum allowable case temperature $T_C = f(I_{TAVM})$

Beidseitige Kühlung / Two-sided cooling

Parameter: Stromflußwinkel Θ / current conduction angle Θ

Netz-Thyristor
Phase Control Thyristor

T 829 N 20 ...26

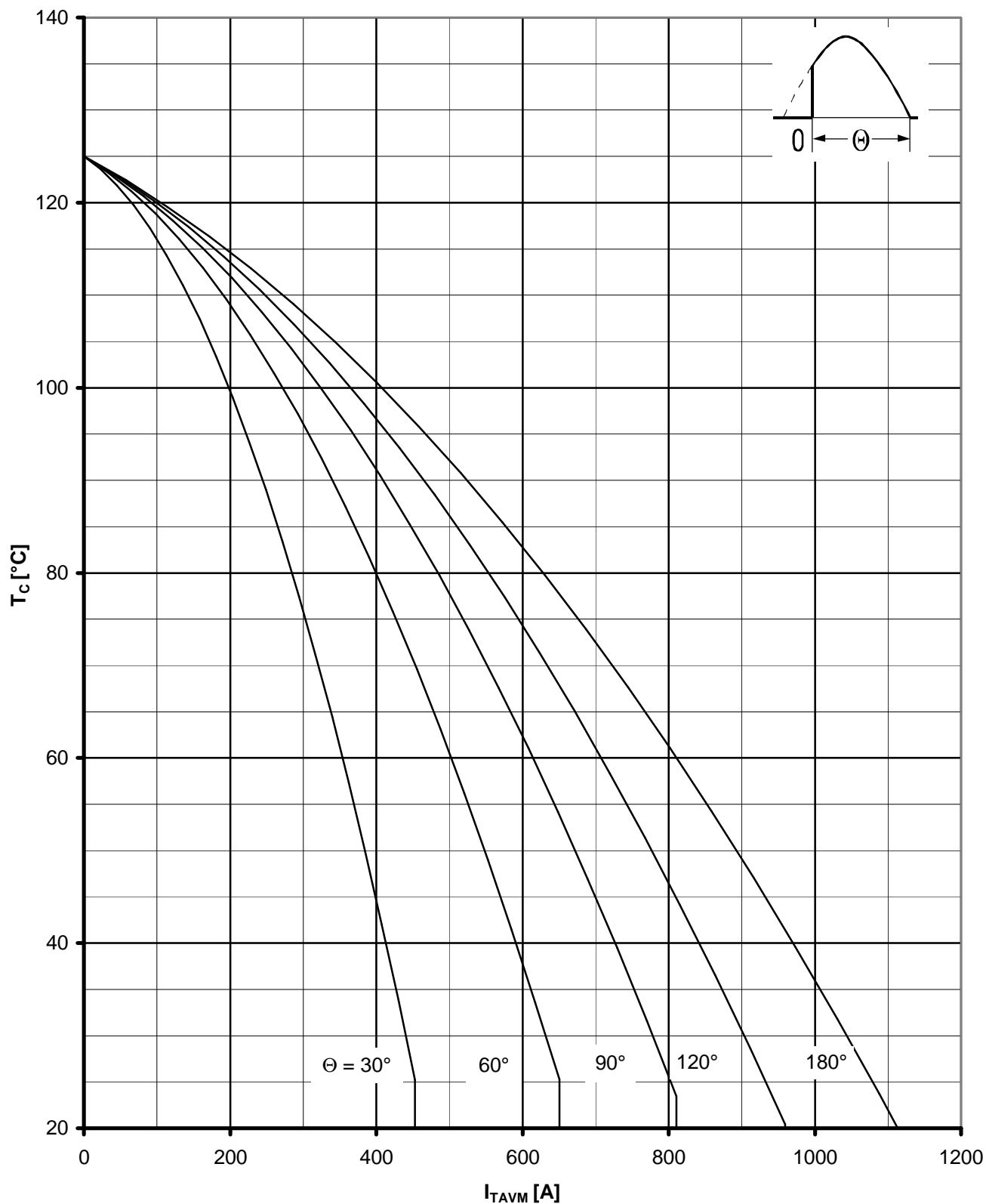
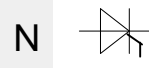

Höchstzulässige Gehäusetemperatur / Maximum allowable case temperature $T_c = f(I_{TAVM})$

Anodenseitige Kühlung / anode sided cooling

Parameter: Stromflußwinkel θ / current conduction angle θ

Netz-Thyristor
Phase Control Thyristor

T 829 N 20 ...26

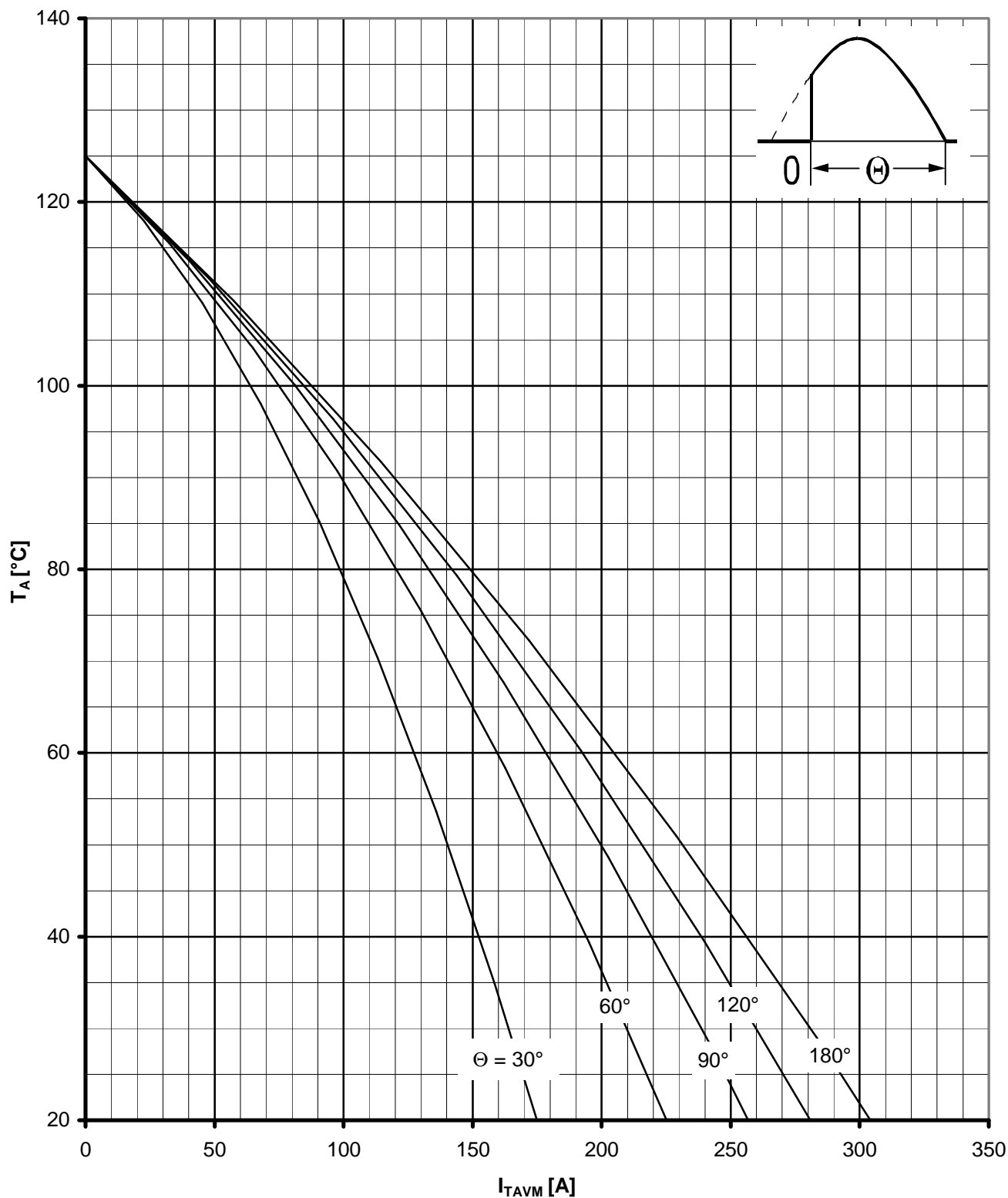
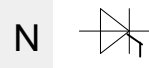

Höchstzulässige Kühlmitteltemperatur / Max. allowable cooling medium temperature $T_A = f(I_{TAVM})$

Luftselbstkühlung / Natural air-cooling

Kühlkörper/Heatsink. K0.05 F

Parameter: Stromflußwinkel θ / current conduction angle θ

Netz-Thyristor
Phase Control Thyristor

T 829 N 20 ...26

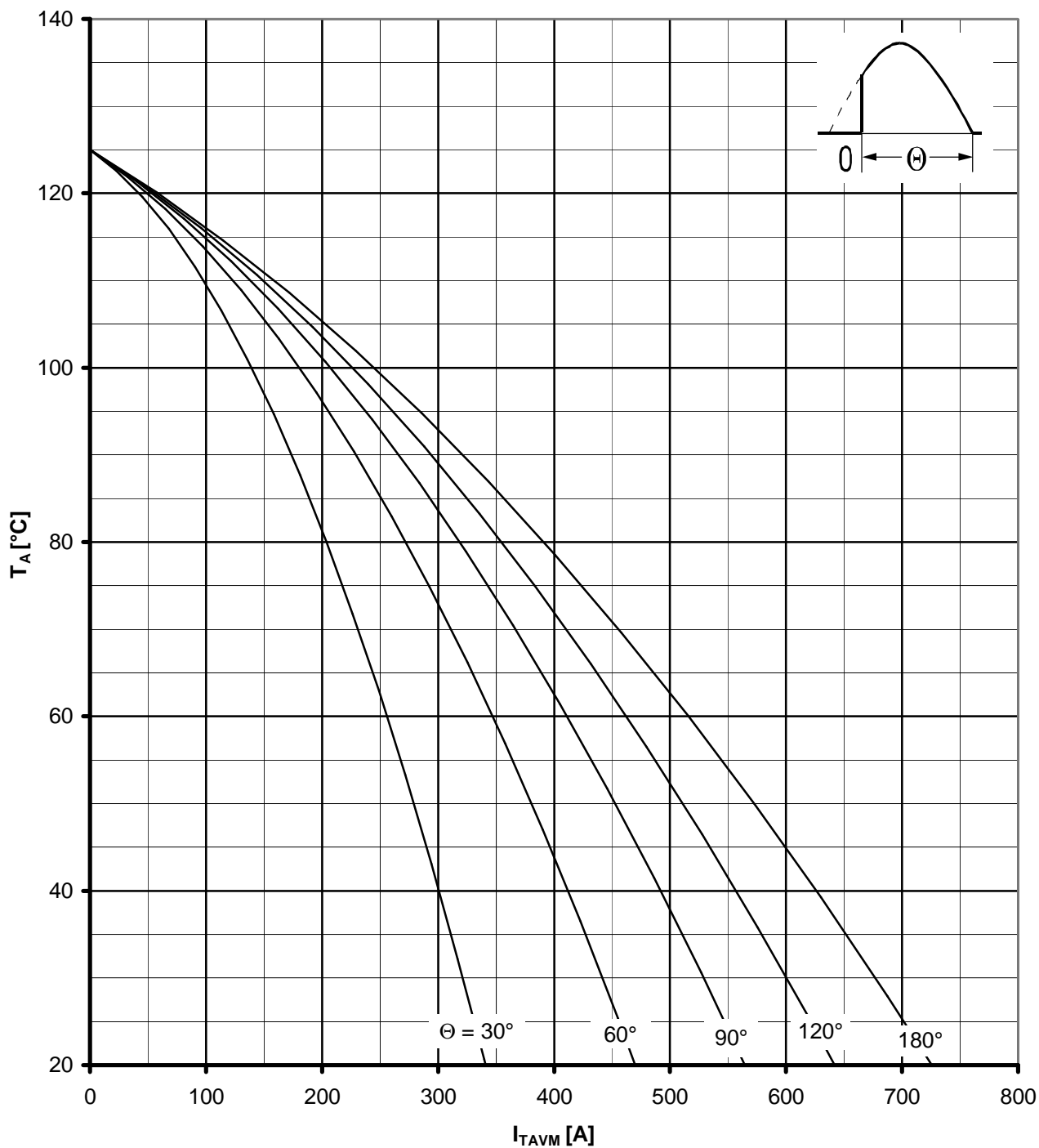

Hochstzulässige Kühlmitteltemperatur / Max. allowable cooling medium temperature $I_A = f(I_{TAVM})$

Verstärkte Luftkühlung / Forced air-cooling

Kühlkörper/Heatsink. K0.05F, $V_L = 120$ l/s

Parameter: Stromflußwinkel θ / current conduction angle θ

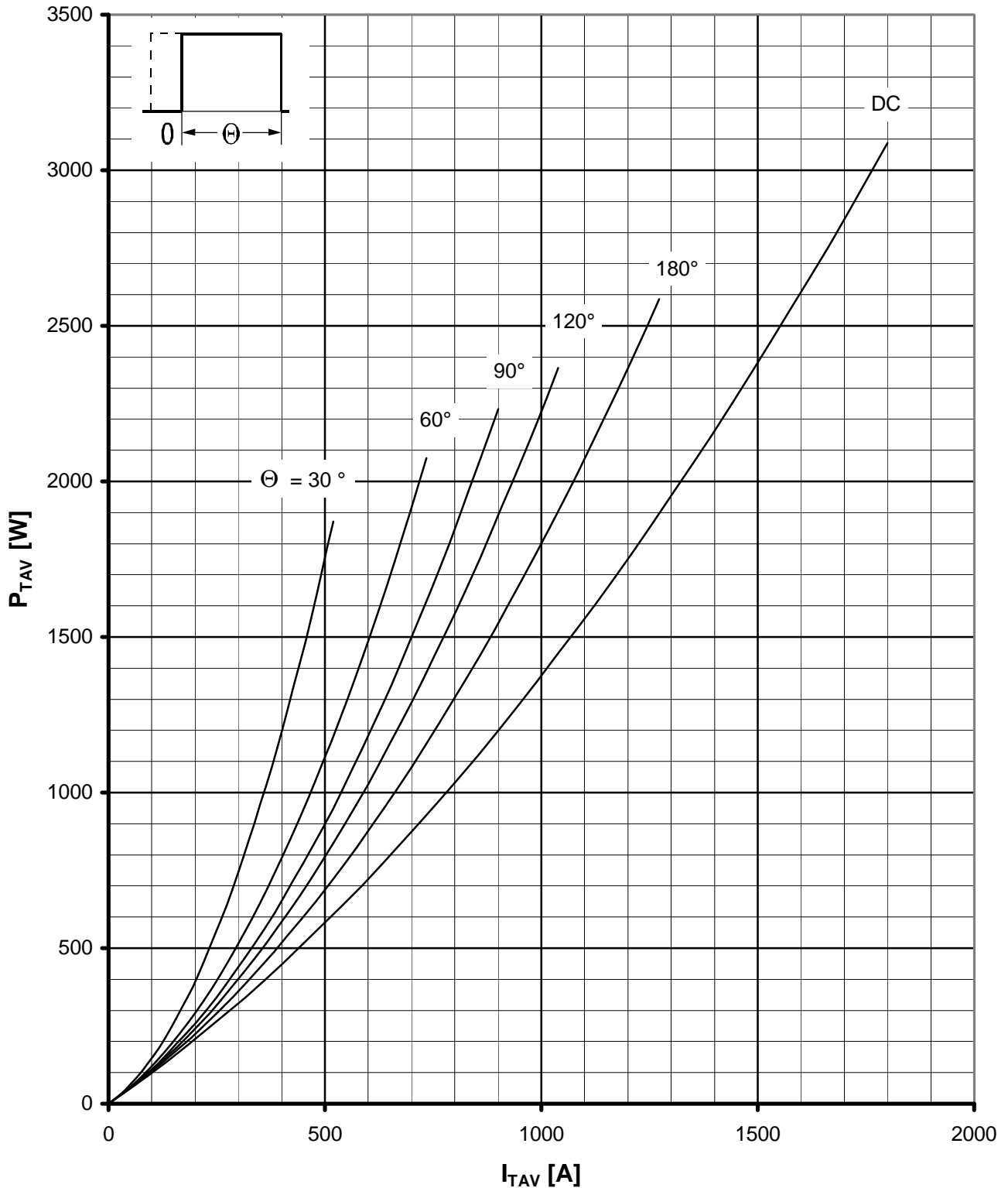

Durchlaßverlustleistung / On-state power loss $P_{TAV} = f(I_{TAV})$
 Parameter: Stromflußwinkel θ / current conduction angle θ

Netz-Thyristor
Phase Control Thyristor

T 829 N 20 ...26

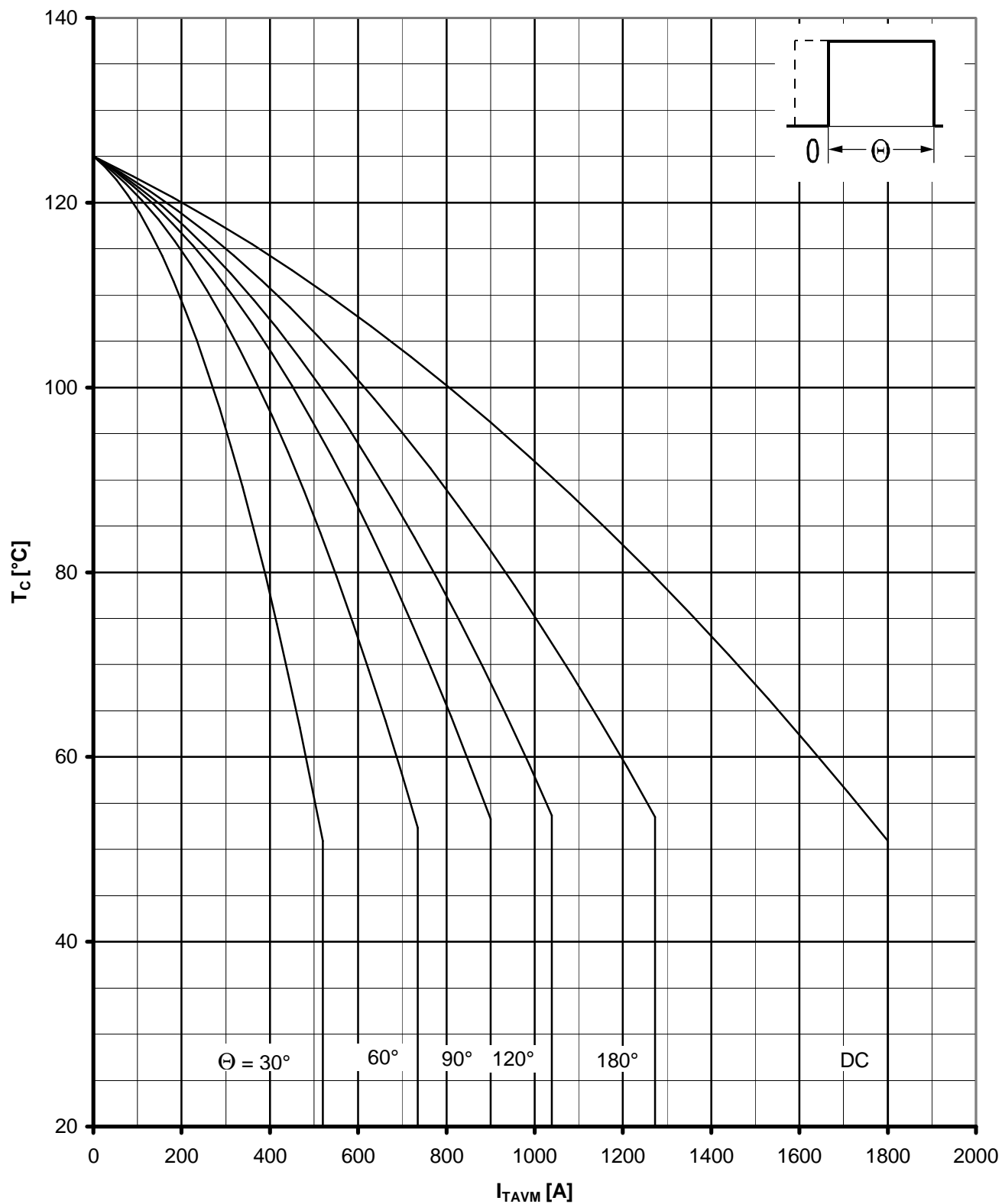

Höchstzulässige Gehäusetemperatur / Maximum allowable case temperature $T_c = f(I_{TAVM})$

Beidseitige Kühlung / Two-sided cooling

Parameter: Stromflußwinkel θ / current conduction angle θ

Netz-Thyristor
Phase Control Thyristor

T 829 N 20 ...26

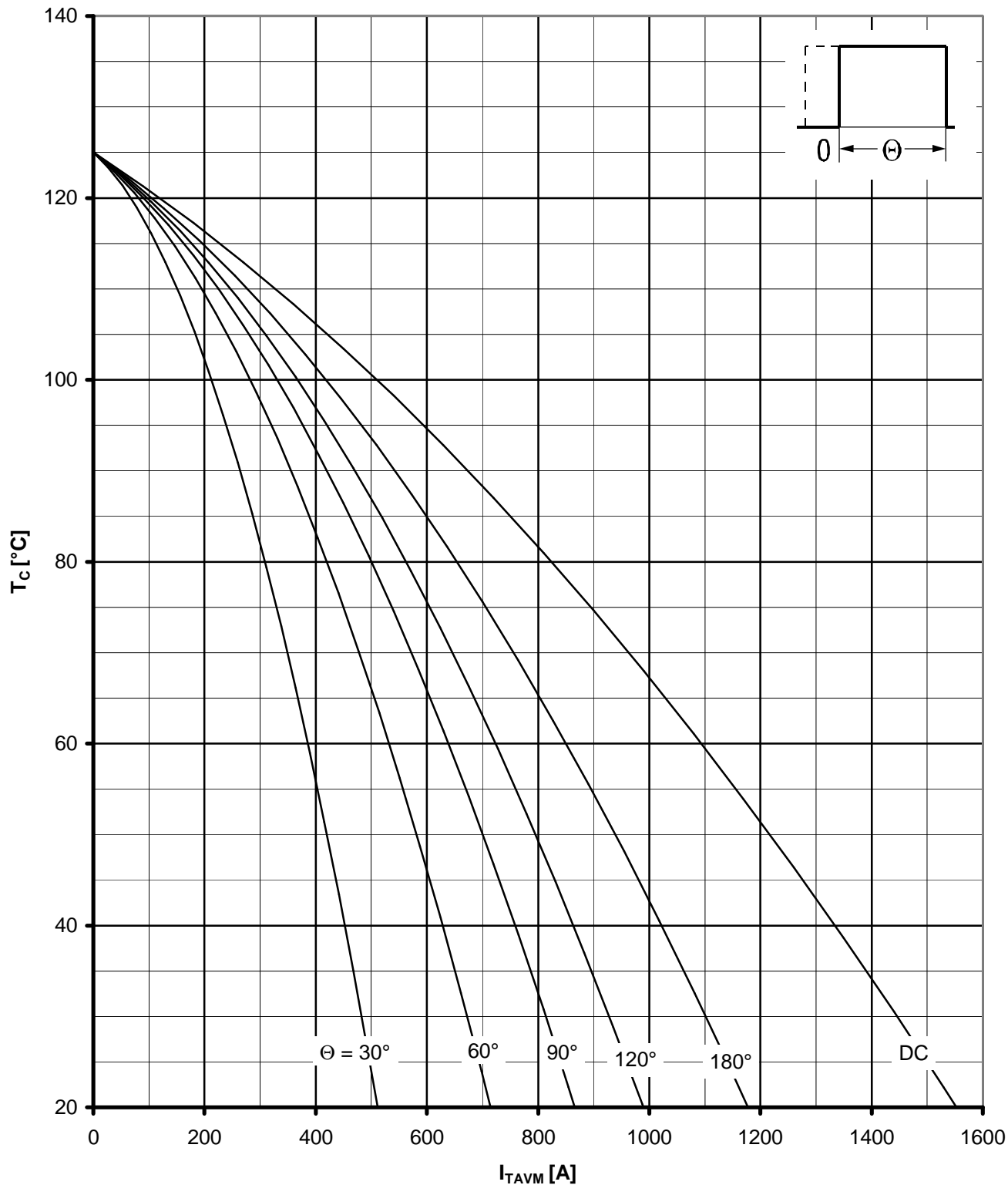
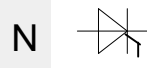

Höchstzulässige Gehäusetemperatur / Maximum allowable case temperature $T_c = f(I_{TAVM})$

Anodenseitige Kühlung / anode sided cooling

Parameter: Stromflußwinkel θ / current conduction angle θ

Netz-Thyristor
Phase Control Thyristor

T 829 N 20 ...26

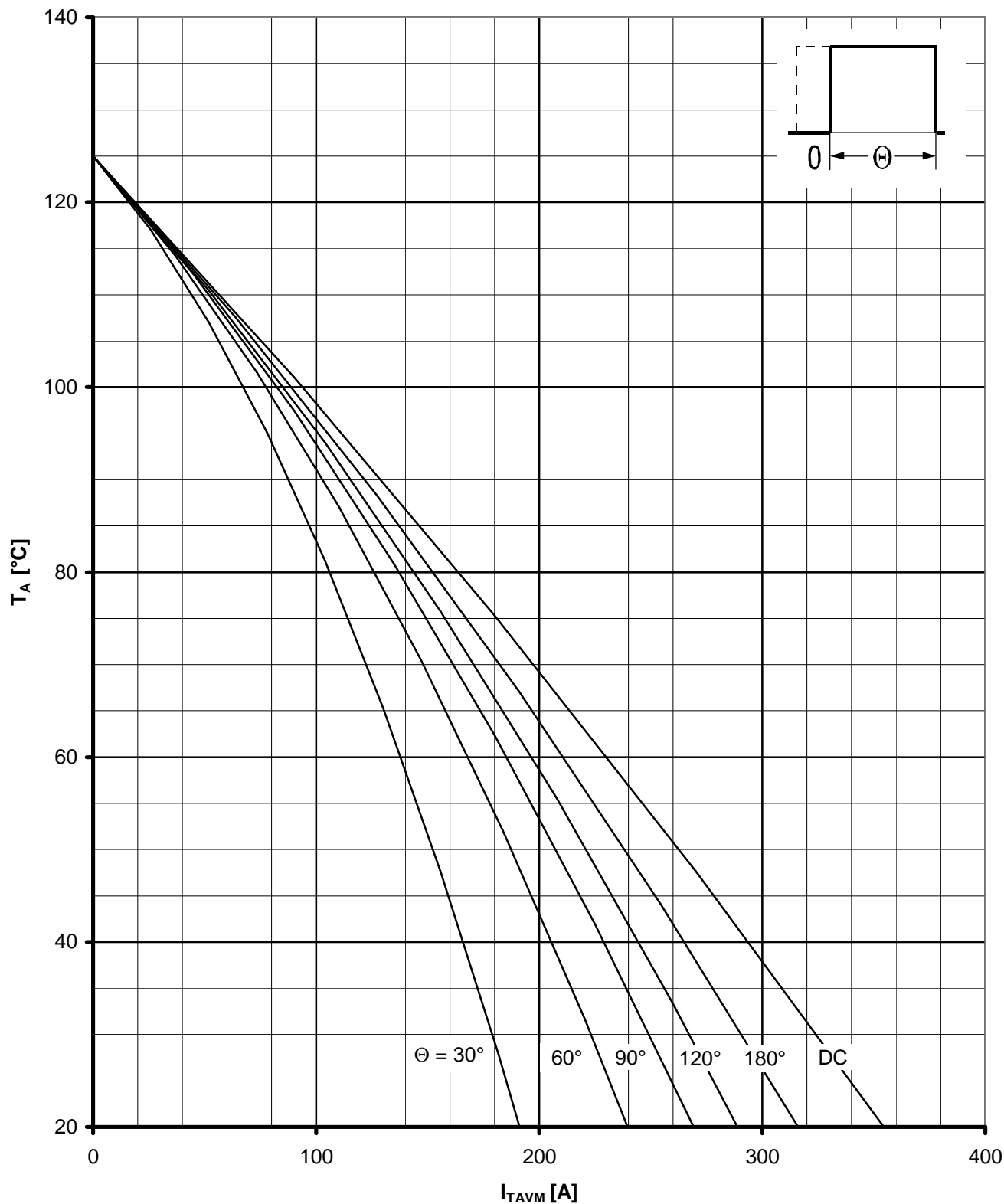

Höchstzulässige Kühlmitteltemperatur / Max. allowable cooling medium temperature $T_A = f(I_{TAVM})$
 Luftselbstkühlung / Natural air-cooling
 Kühlkörper/Heatsink. K0.05 F
 Parameter: Stromflußwinkel θ / current conduction angle θ

Netz-Thyristor
Phase Control Thyristor

T 829 N 20 ...26

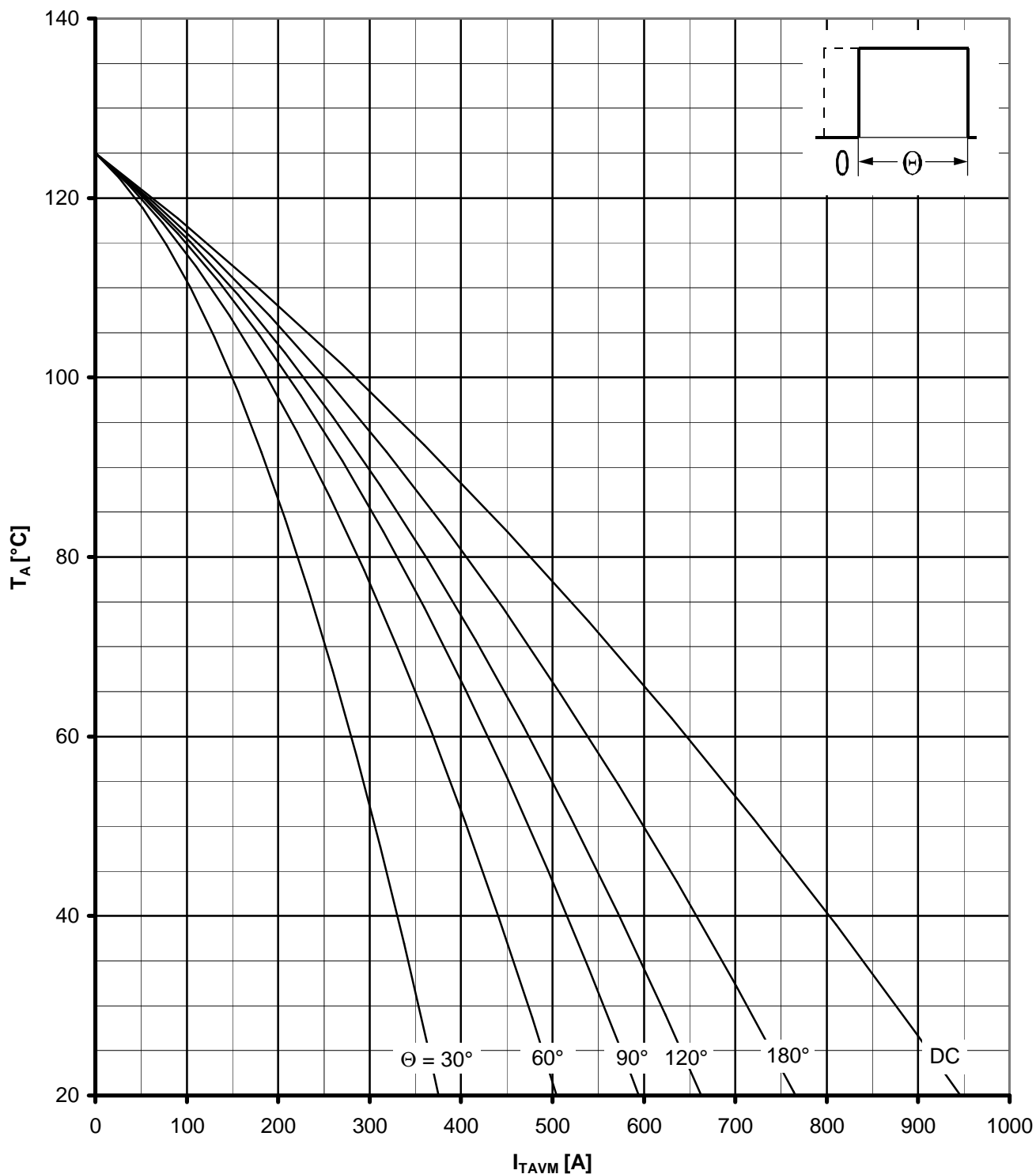
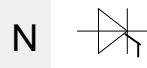

Hochstzulässige Kühlmitteltemperatur / Max. allowable cooling medium temperature $I_A = f(I_{TAVM})$

Verstärkte Luftkühlung / Forced air-cooling

Kühlkörper/Heatsink. K0.05F, $V_L = 120$ l/s

Parameter: Stromflußwinkel θ / current conduction angle θ

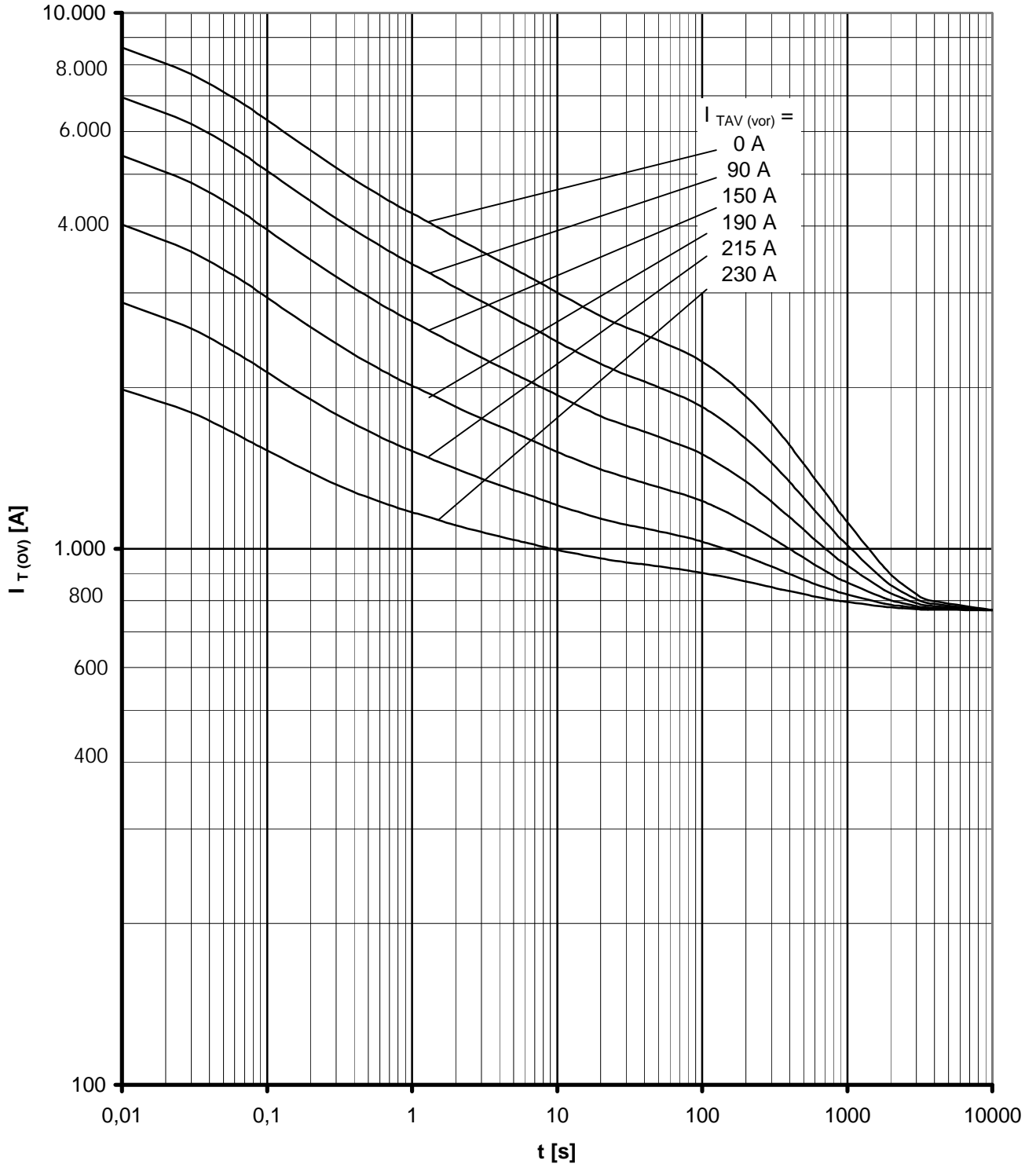

Überstrom / Overload on-state current $I_{T(OV)} = f(t)$

Beidseitige Luftselbstkühlung / Two-sided natural cooling K 0.36 S
 $T_A = 45^\circ\text{C}$

Parameter: Vorlaststrom / pre-load current $I_{TAV(vor)}$

Netz-Thyristor
Phase Control Thyristor

T 829 N 20 ...26

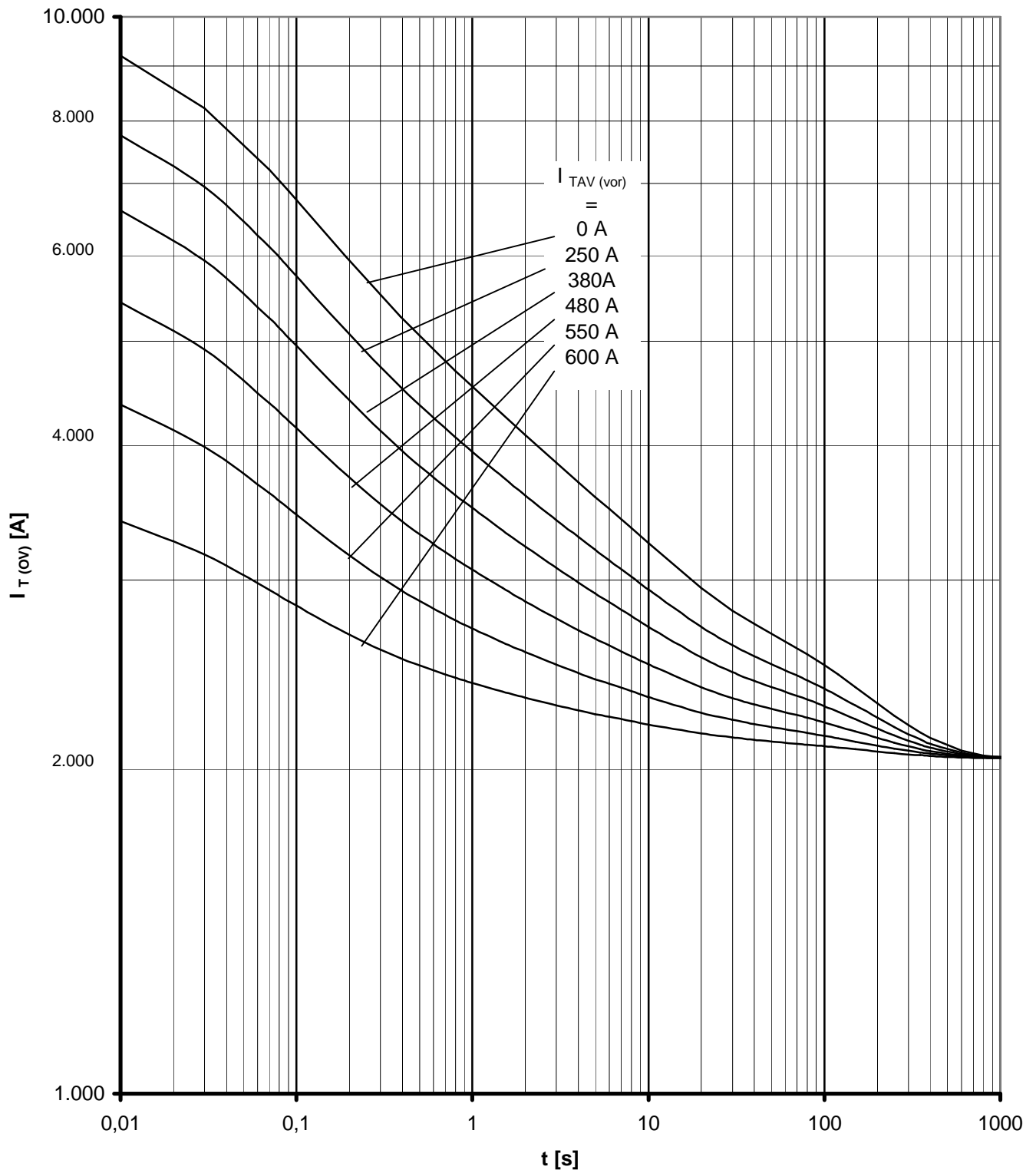

Überstrom / Overload on-state current $I_{T(OV)} = f(t)$

Beidseitige verstärkte Kühlung / forced two-sided cooling K0.05 F

$T_A = 35^\circ\text{C}$, $V_L = 120$ l/s

Parameter: Vorlaststrom / pre-load current $I_{TAV(vor)}$

Netz-Thyristor
Phase Control Thyristor

T 829 N 20 ...26

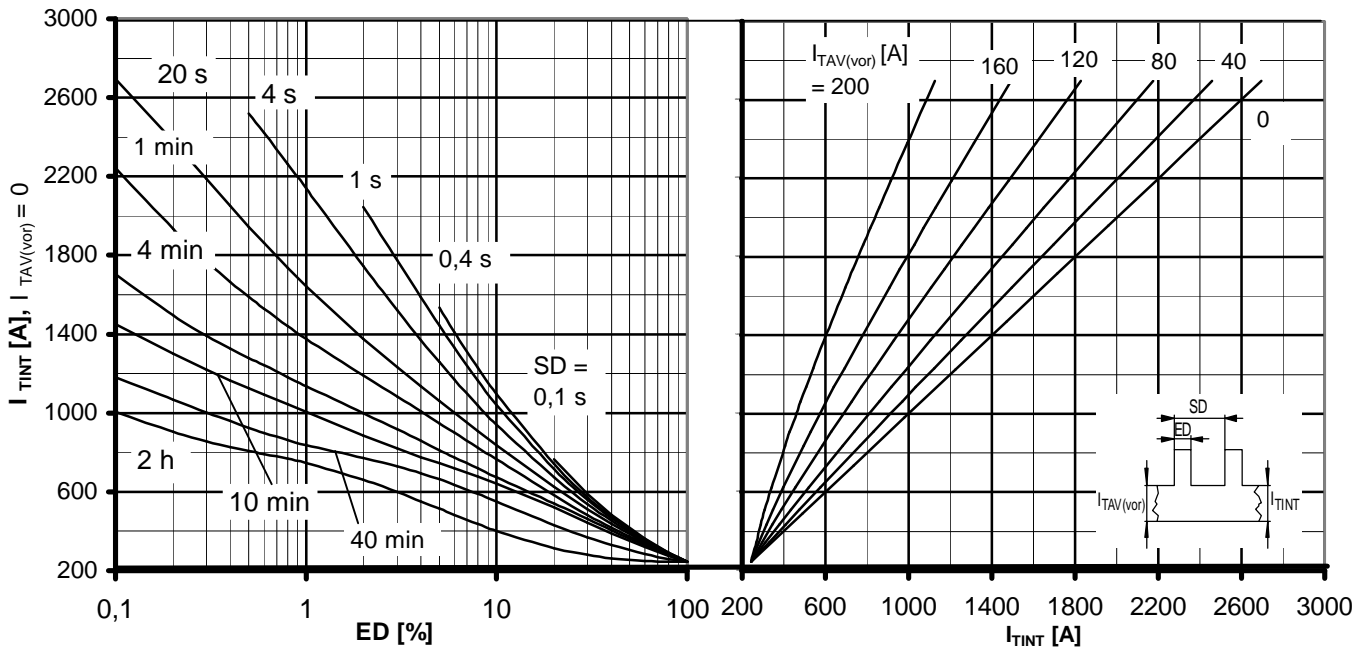
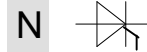

Höchstzul. Durchlaßstrom bei Ausetzbetrieb / Max. allowable on-state current during intermittent operation $I_{TINT} = f(ED)$

Beidseitig Luftselbstkühlung / two-sided natural cooling $K 0.05F$
 $T_A = 45\text{ °C}$

Parameter: Vorlaststrom / pre-load current $I_{TAV(vor)}$, Spieldauer / cycle duration SD

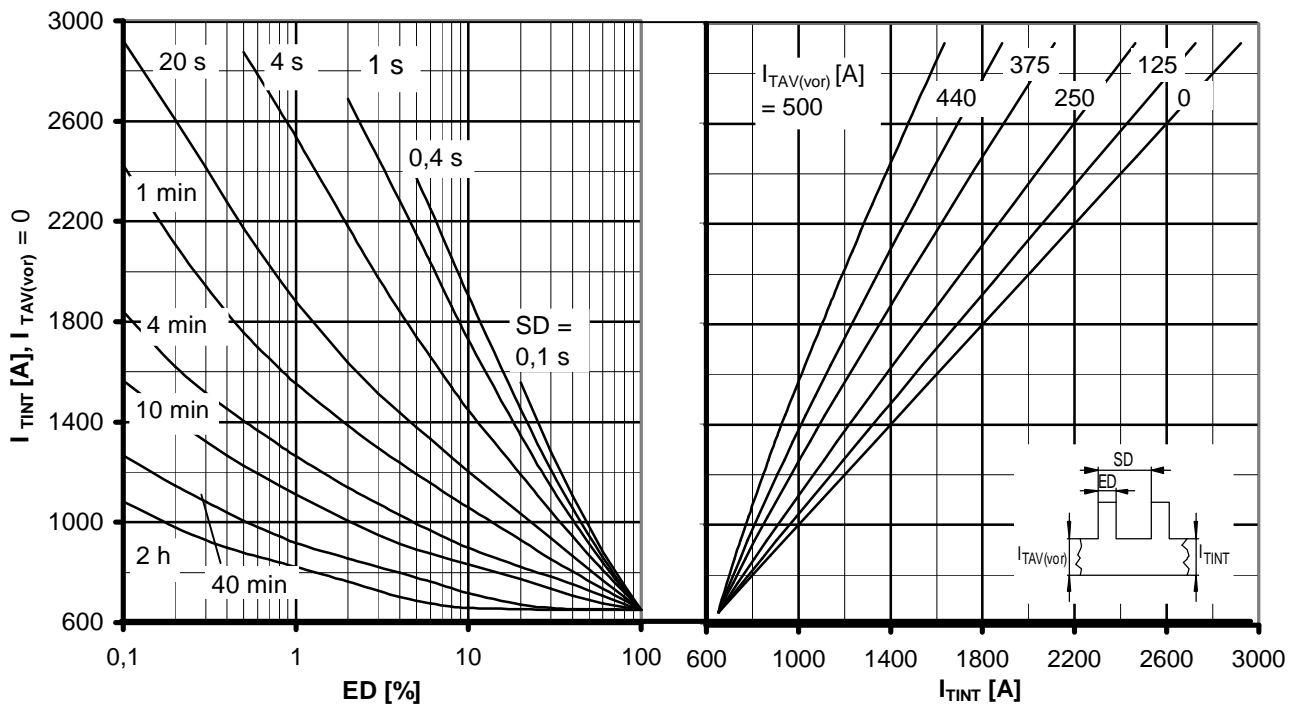

Höchstzul. Durchlaßstrom bei Ausetzbetrieb / Max. allowable on-state current during intermittent operation $I_{TINT} = f(ED)$

Beidseitig verstärkte Kühlung / forced two-sided cooling $K 0.05F$
 $T_A = 35\text{ °C}$, $V_L = 120\text{ l/s}$

Parameter: Vorlaststrom / pre-load current $I_{TAV(vor)}$, Spieldauer / cycle duration SD

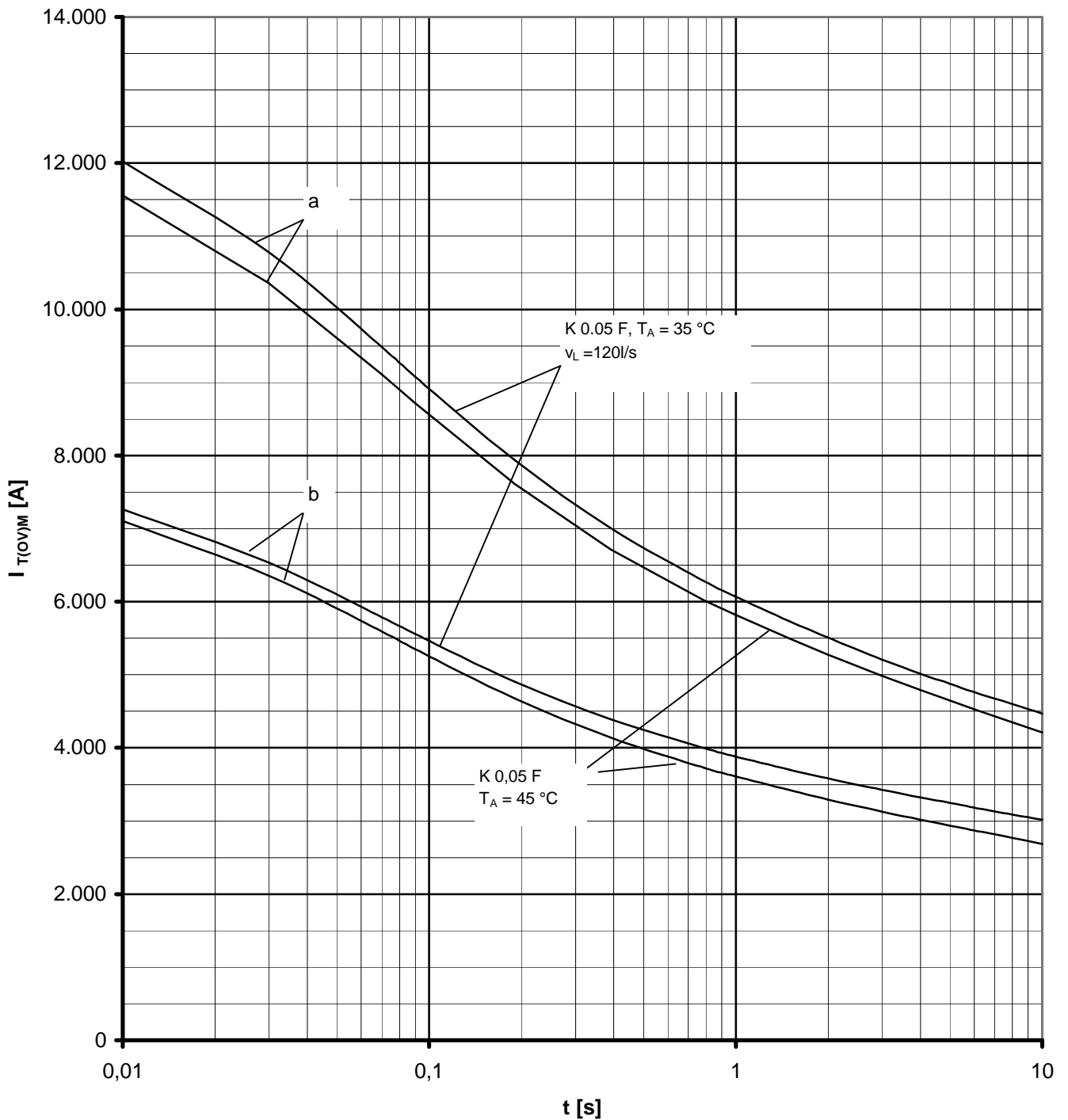

Grenzstrom / Max. overload on-state current $I_{T(OV)M} = f(t)$, $v_{RM} = 0,8 V_{RRM}$

Beidseitige Kühlung / Two-sided cooling

Kühlkörper / Heatsink: K 0.05 F

Belastung aus / Surge current occurs:

a - Leerlauf / No-load conditions

b - Betrieb mit Dauergrenzstrom / During operation at max. average on-state current I_{TAVM}

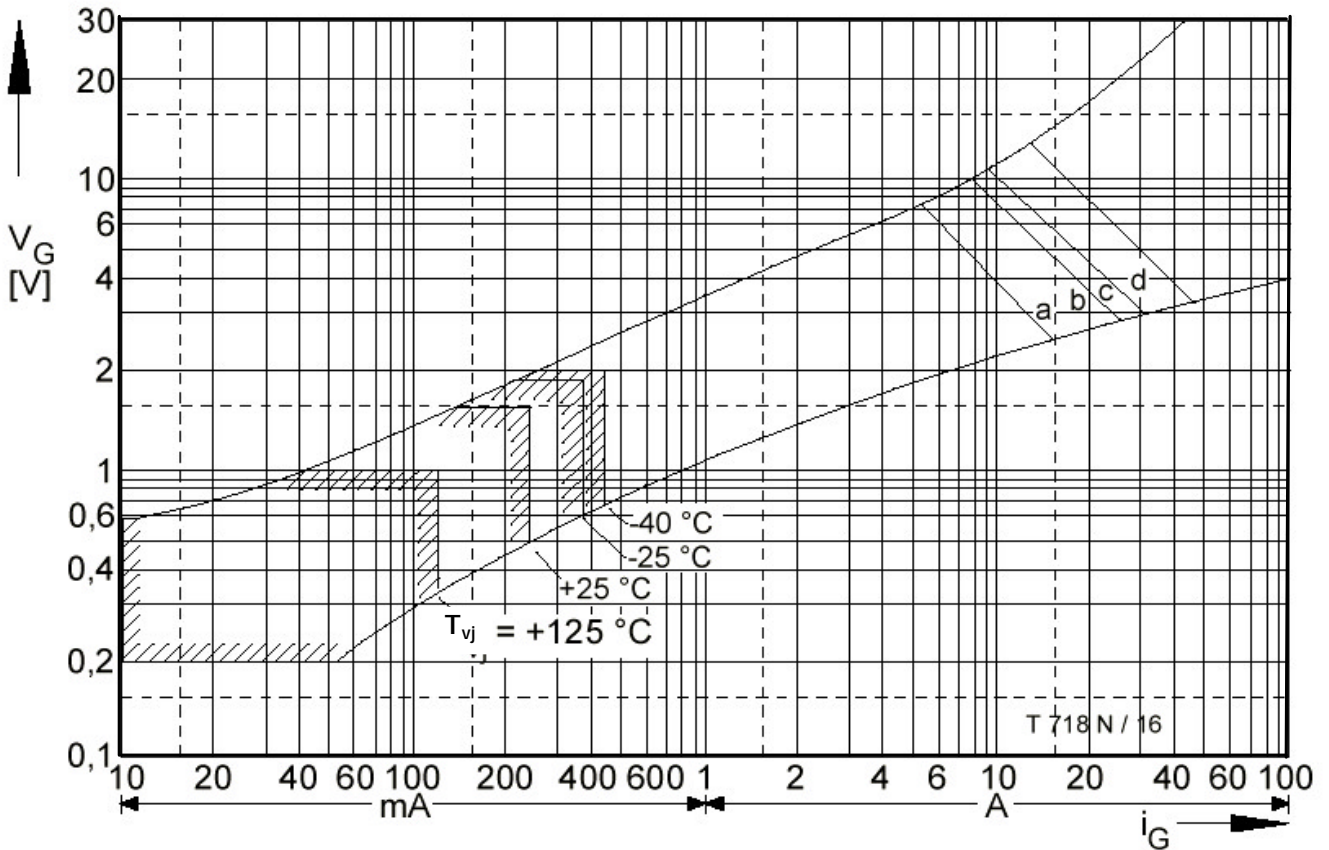

Steuercharakteristik $v_G = f(i_G)$ mit Zündbereichen für $V_D = 6\text{ V}$

Gate characteristic $v_G = f(i_G)$ with triggering area for $V_D = 6\text{ V}$

Höchstzulässige Spitzensteuerverlustleistung / Maximum rated peak gate power dissipation $P_{GM} = f(t_g)$:

a - 40 W/10ms b - 80 W/1ms c - 100 W/0,5ms d - 150 W/0,1ms

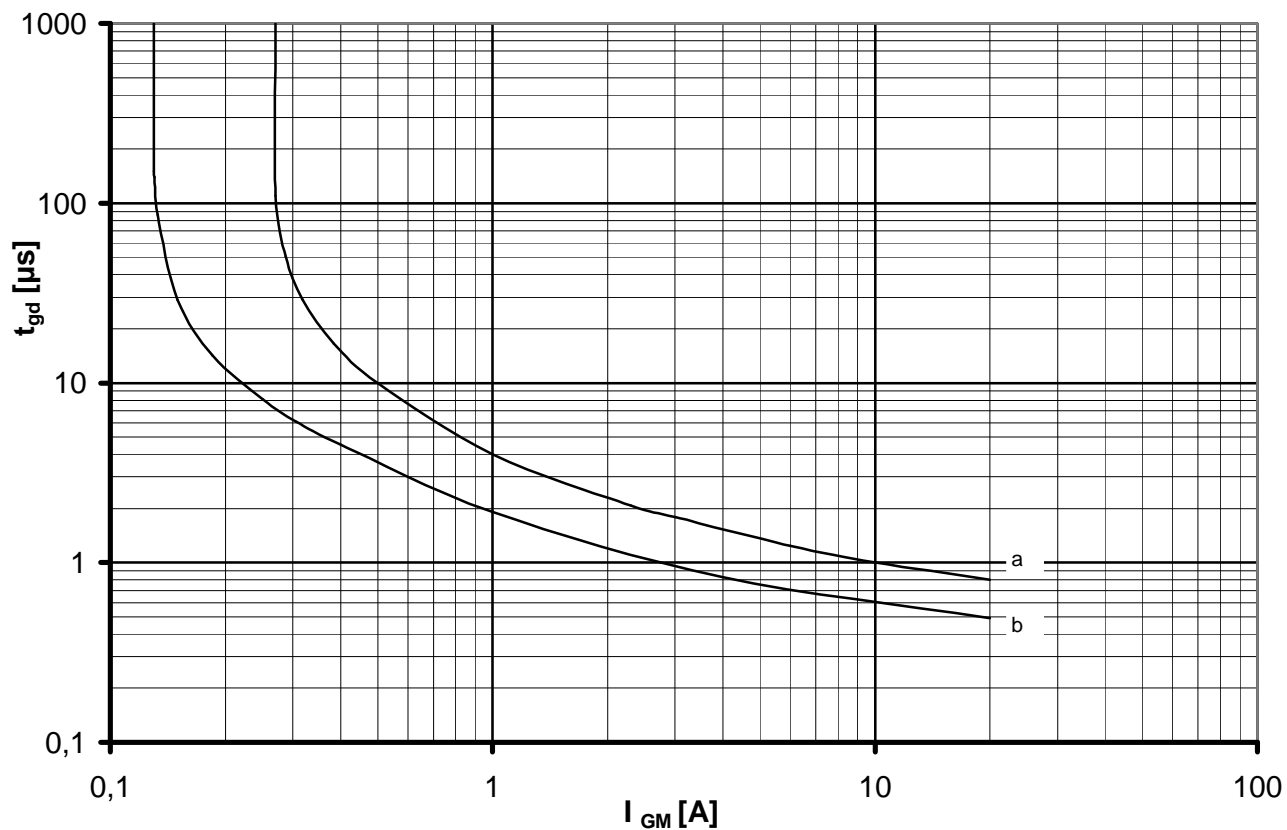

Zündverzug / Gate controlled delay time $t_{gd} = f(i_{GM})$

$T_{vj} = 25^{\circ}\text{C}$, $di_G/dt = i_{GM}/1\mu\text{s}$

a - maximaler Verlauf / limiting characteristic

b - typischer Verlauf / typical characteristic

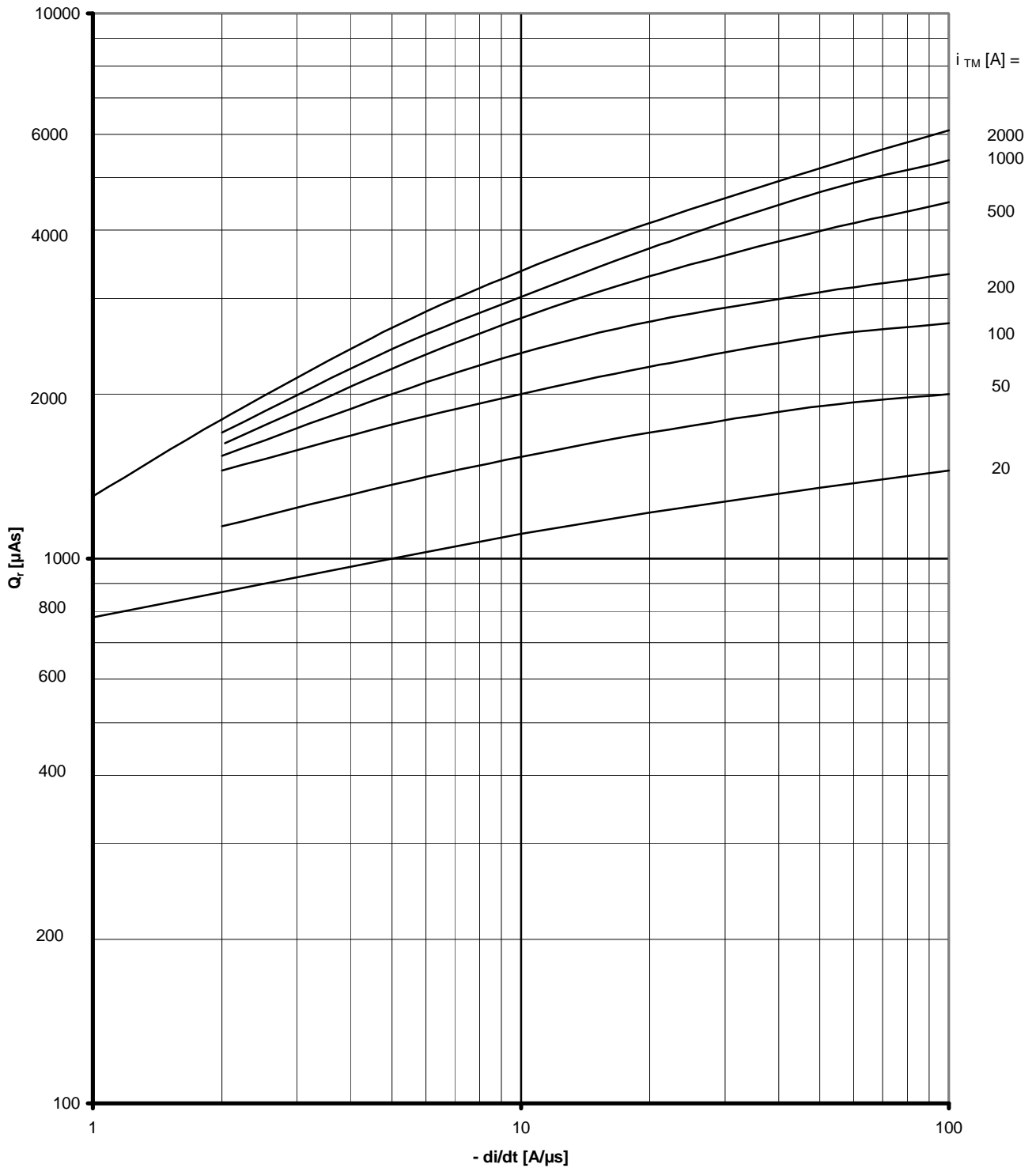

Sperrverzögerungsladung / Recovered charge $Q_r = f(di/dt)$

$T_{vj} = T_{vj \text{ max}}$, $V_R = 0,5 V_{RRM}$, $V_{RM} = 0,8 V_{RRM}$

Parameter: Durchlaßstrom / On-state current i_{TM}

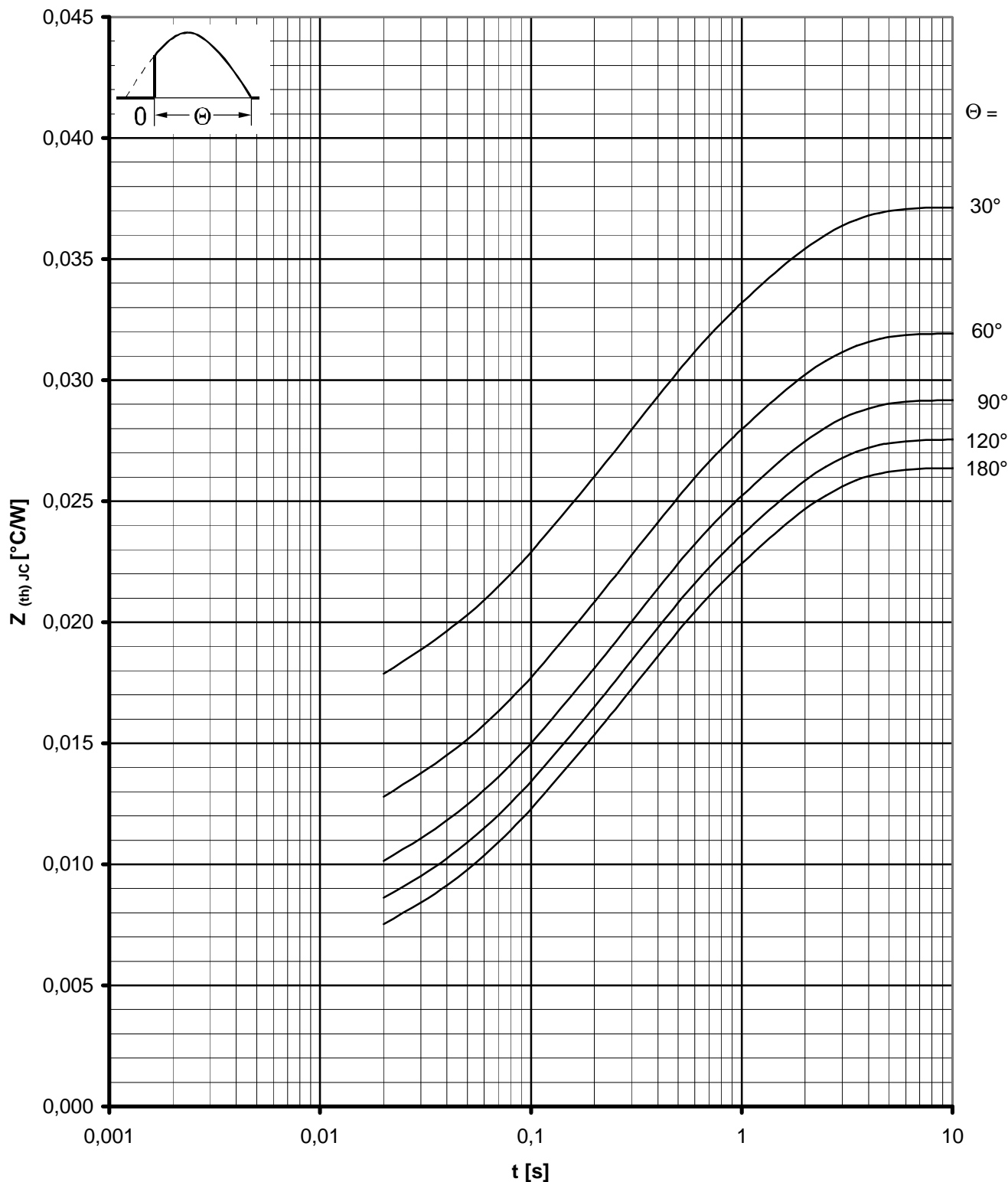

Transienter innerer Wärmewiderstand / Transient thermal impedance $Z_{(th)JC} = f(t)$

Beidseitige Kühlung / Two-sided cooling

Parameter: Stromflußwinkel Θ / current conduction angle Θ

Netz-Thyristor
Phase Control Thyristor

T 829 N 20 ...26

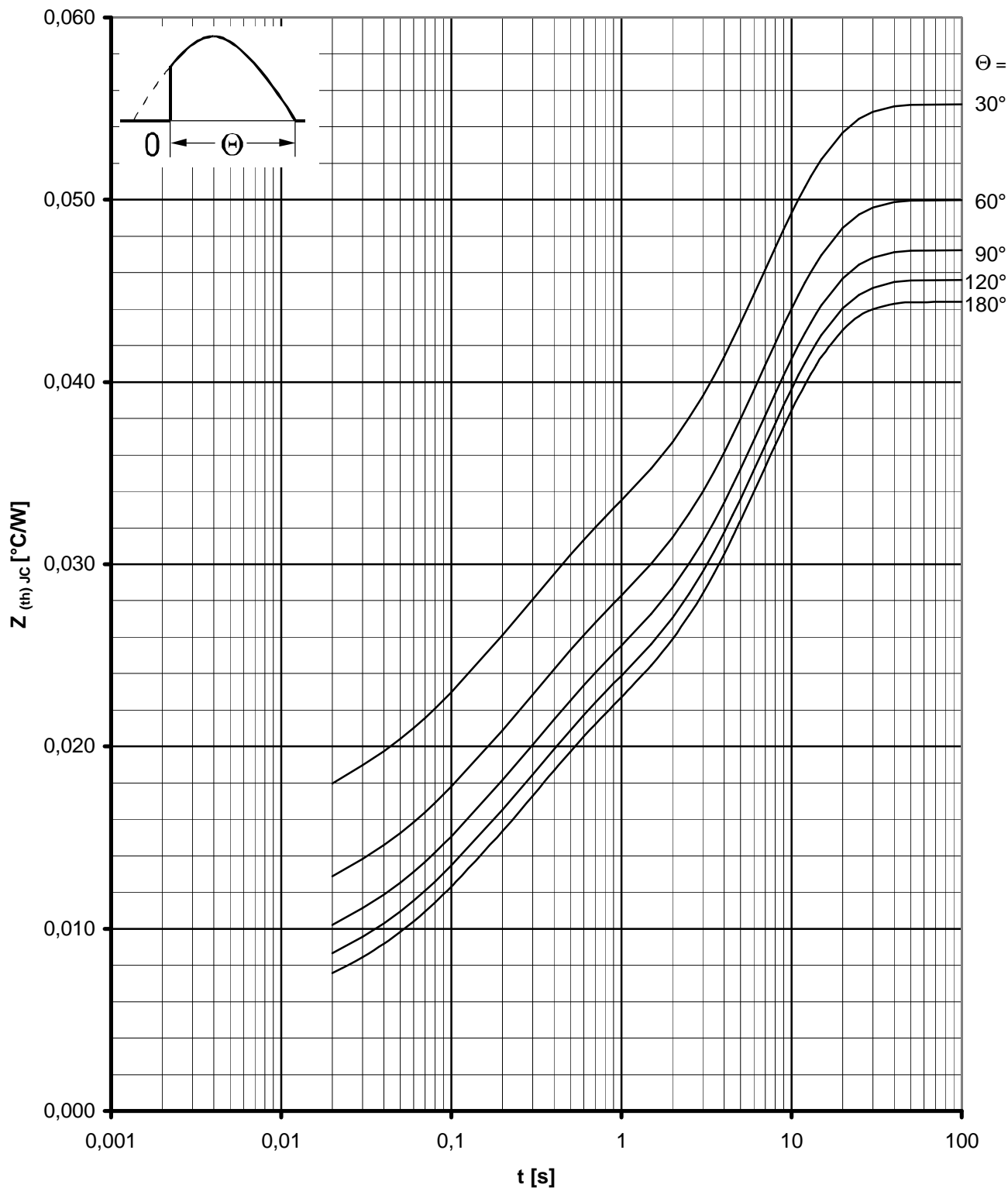

Transienter innerer Wärmewiderstand / Transient thermal impedance $Z_{(th)JC} = f(t)$
 Anodenseitige Kühlung / Anode-sided cooling
 Parameter: Stromflußwinkel Θ / current conduction angle Θ

Netz-Thyristor
Phase Control Thyristor

T 829 N 20 ...26

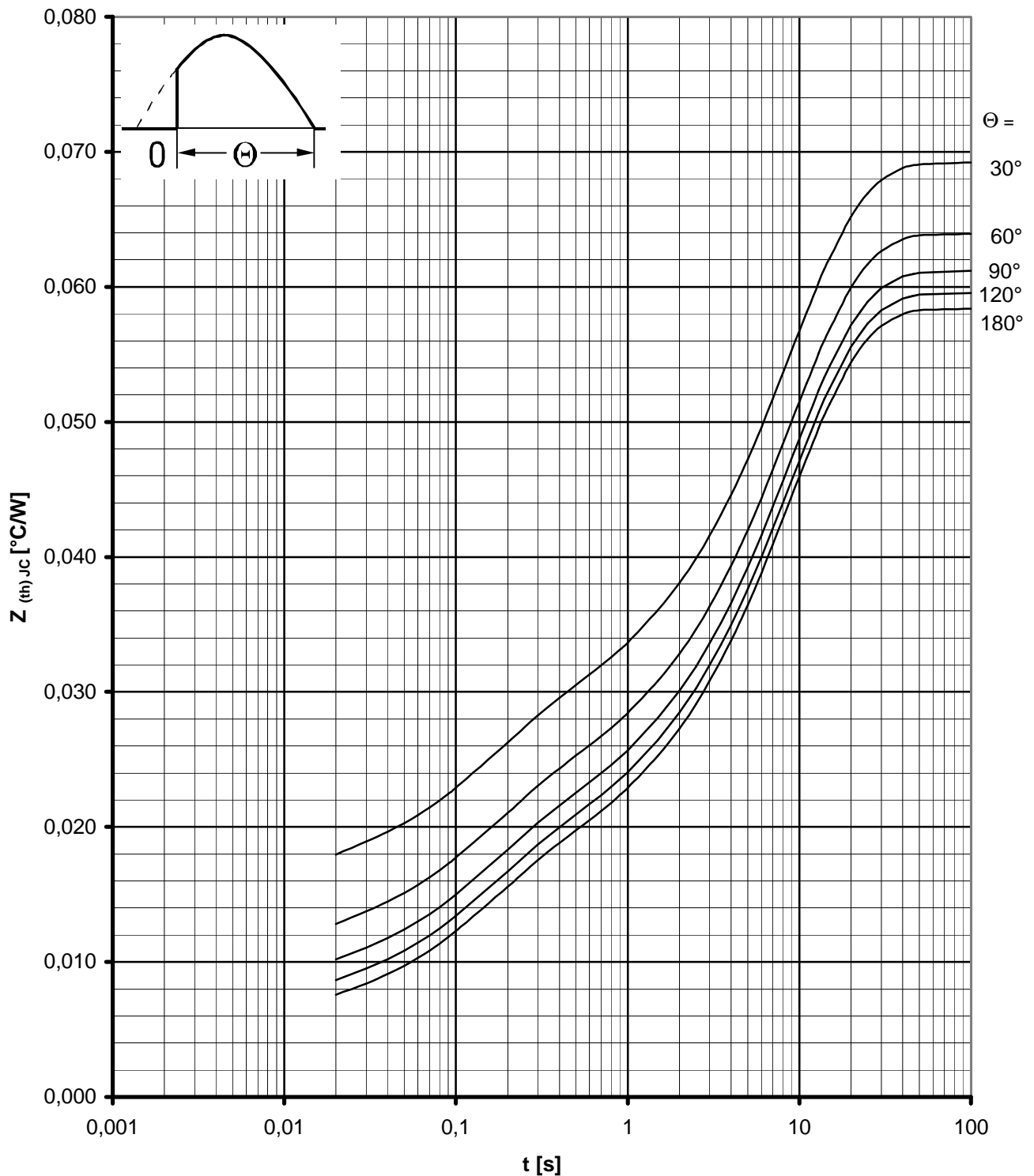
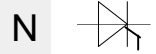

Transienter innerer Wärmewiderstand / Transient thermal impedance $Z_{(th)JC} = f(t)$
 Kathodenseitige Kühlung / Cathde-sided cooling
 Parameter: Stromflußwinkel Θ / current conduction angle Θ

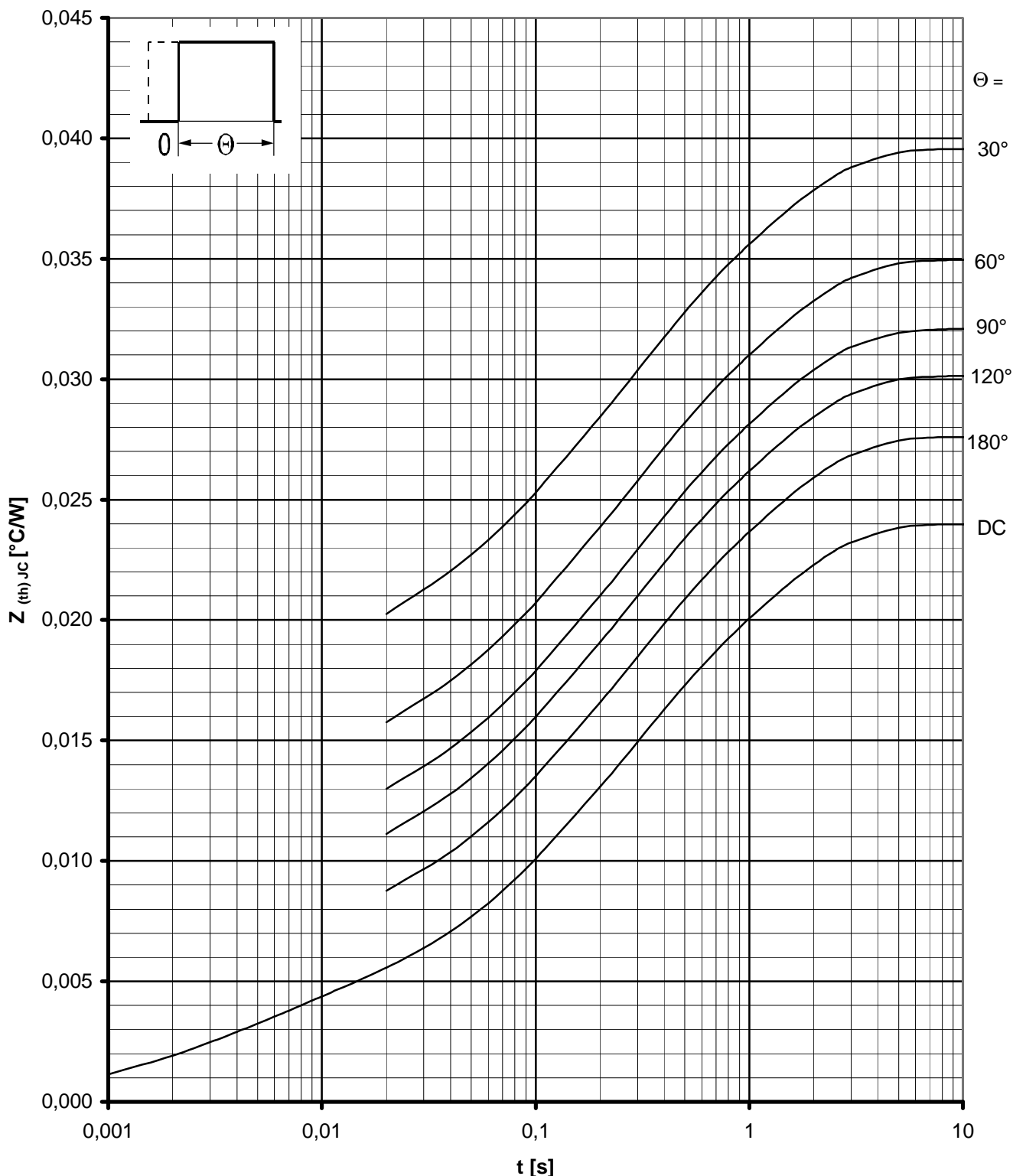

Transienter innerer Wärmewiderstand / Transient thermal impedance $Z_{(th)JC} = f(t)$
 Beidseitige Kühlung / Two-sided cooling
 Parameter: Stromflußwinkel θ / current conduction angle θ

Netz-Thyristor
Phase Control Thyristor

T 829 N 20 ...26

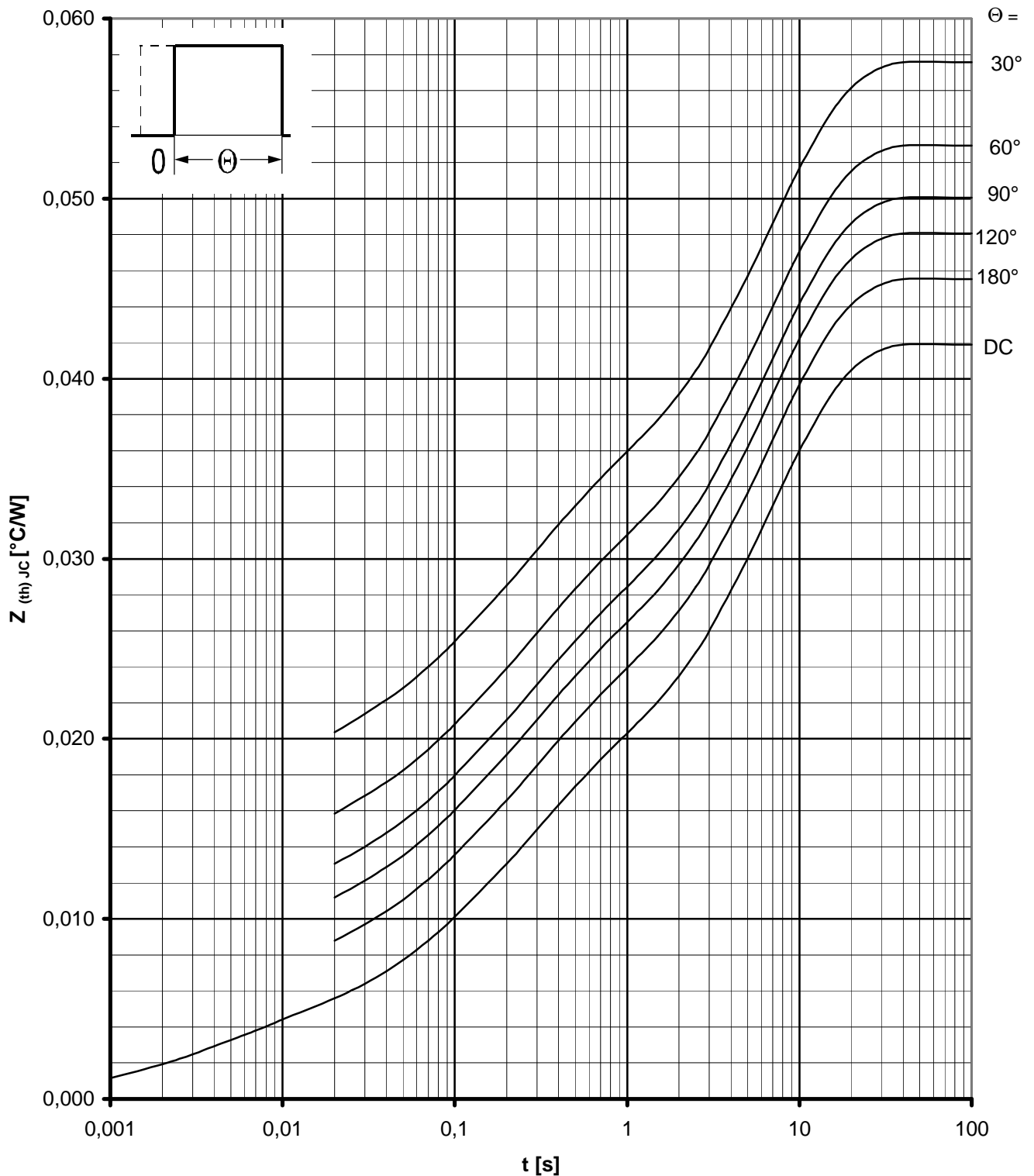
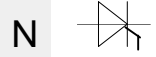

Transienter innerer Wärmewiderstand / Transient thermal impedance $Z_{(th)JC} = f(t)$
 Anodenseitige Kühlung / Anode-sided cooling
 Parameter: Stromflußwinkel Θ / current conduction angle Θ

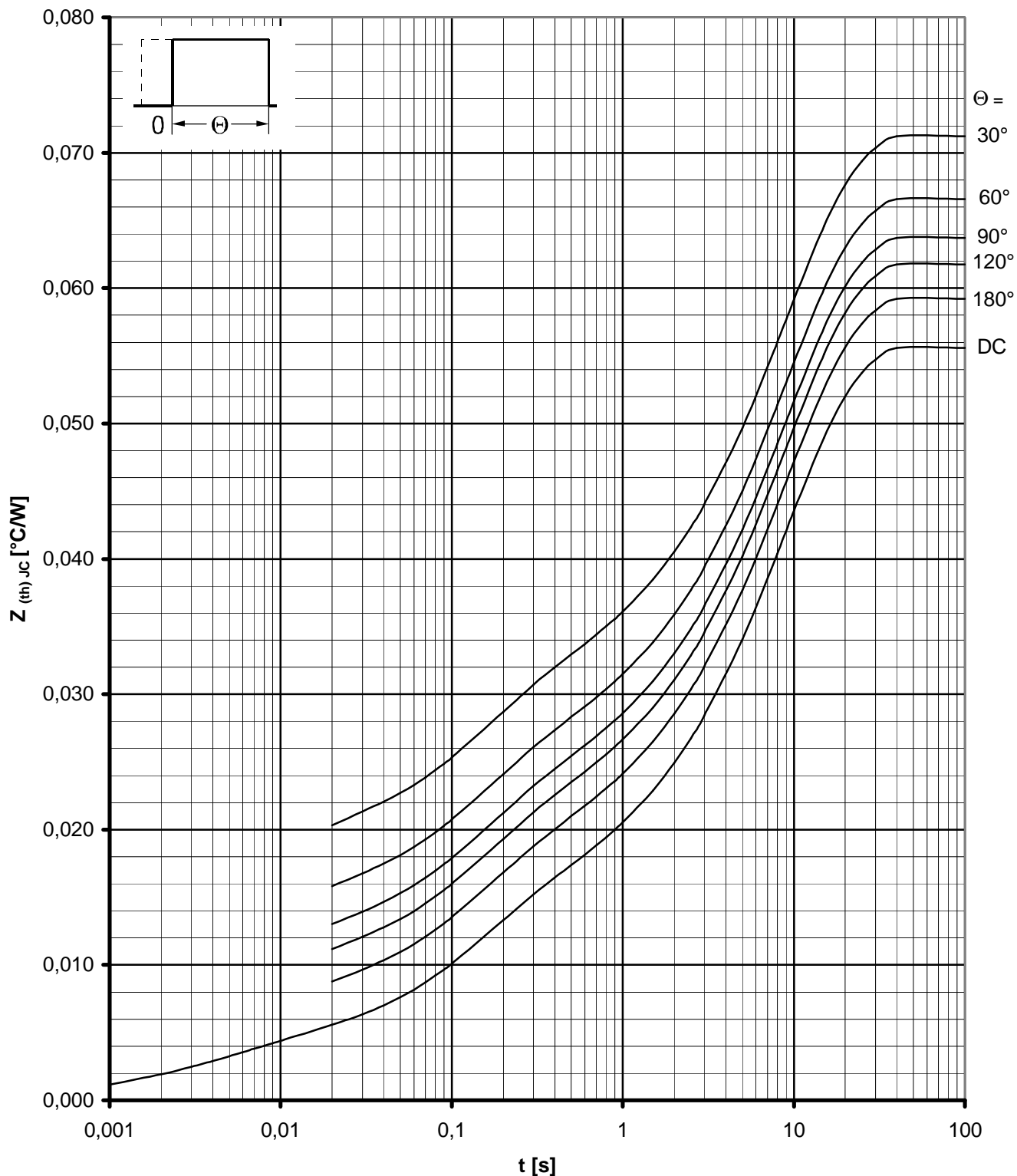

Transienter innerer Wärmewiderstand / Transient thermal impedance $Z_{(th)JC} = f(t)$
 Kathodenseitige Kühlung / Cathode-sided cooling
 Parameter: Stromflußwinkel Θ / current conduction angle Θ