

Secure Digital (SD) Card EMI Filter Array with ESD Protection

Features

- Provides EMI filtering and ESD protection for an SD port on a mobile device
- Six channels of EMI filtering with ESD protection
- Four channels of ESD protection
- $\pm 15\text{kV}$ ESD protection on all I/O pins (IEC 61000-4-2, contact discharge)
- $\pm 30\text{kV}$ ESD protection (HBM)
- Better than 25dB of attenuation at 1GHz for 12pF-100 Ω -12pF filter configuration
- Integrates 34 components into small form factor CSP solution
- 20-bump, 4.000mm x 1.458mm footprint Chip Scale Package
- Chip Scale Package features extremely low lead inductance for optimum filter and ESD performance
- Available with OptiGuard™ coated version for improved reliability at assembly
- Lead-free version available

Applications

- Secure Digital (SD) Card data lines in mobile handsets
- SD Card interface protection for other mobile electronics such as MP3 players, PDAs and digital cameras
- I/O port protection for mobile handsets, notebook computers, PDAs etc.
- EMI filtering for data ports in cell phones, PDAs or notebook computers.

Product Description

California Micro Devices's CM1423 is an EMI filter array with ESD protection, which integrates six Pi-filters (C-R-C) and four channels of ESD protection. The CM1423's filters have component values of 12pF-100 Ω -12pF. The part includes ESD protection diodes on every pin, which provide a very high level of protection for sensitive electronic components that may be subjected to electrostatic discharge (ESD). All the ESD diodes are designed and characterized to safely dissipate ESD strikes of $\pm 15\text{kV}$, beyond the maximum requirement of the IEC 61000-4-2 international standard. Using the MIL-STD-883 (Method 3015) specification for Human Body Model (HBM) ESD, the pins are protected for contact discharges at greater than $\pm 30\text{kV}$.

This device is particularly well suited for portable electronics (e.g. mobile handsets, PDAs, notebook computers) because of its small package format and easy-to-use pin assignments. In particular, the CM1423 is ideal for EMI filtering and protecting data lines from ESD for the Secure Digital (SD) Card interface slot in mobile handsets. The CM1423 is an all-inclusive solution for the SD card interface since its EMI filters provide the proper cut-off frequency to attenuate unwanted signals.

The CM1423 is manufactured in a space-saving, low-profile, chip-scale package, and is optionally available with OptiGuard™ coating for improved reliability. It is also available with lead-free finishing.

Electrical Schematic

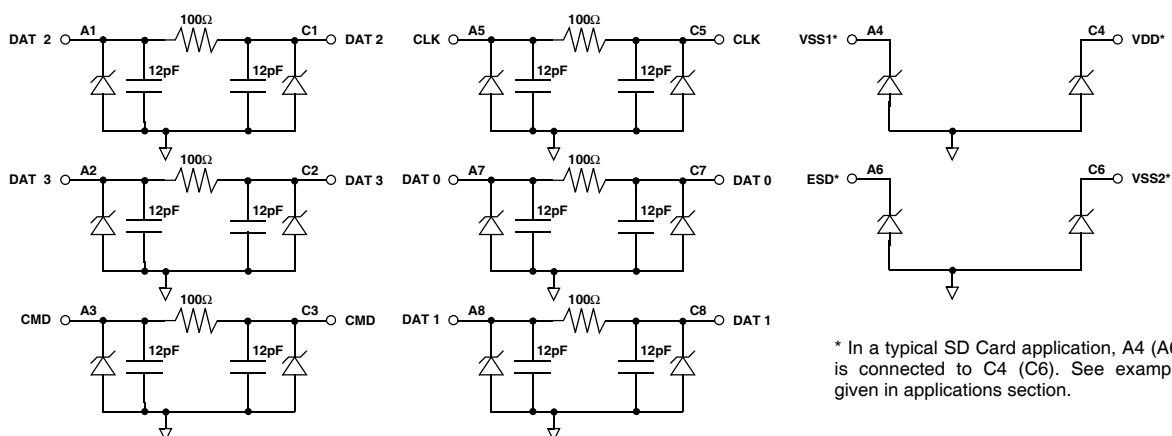

* In a typical SD Card application, A4 (A6) is connected to C4 (C6). See example given in applications section.

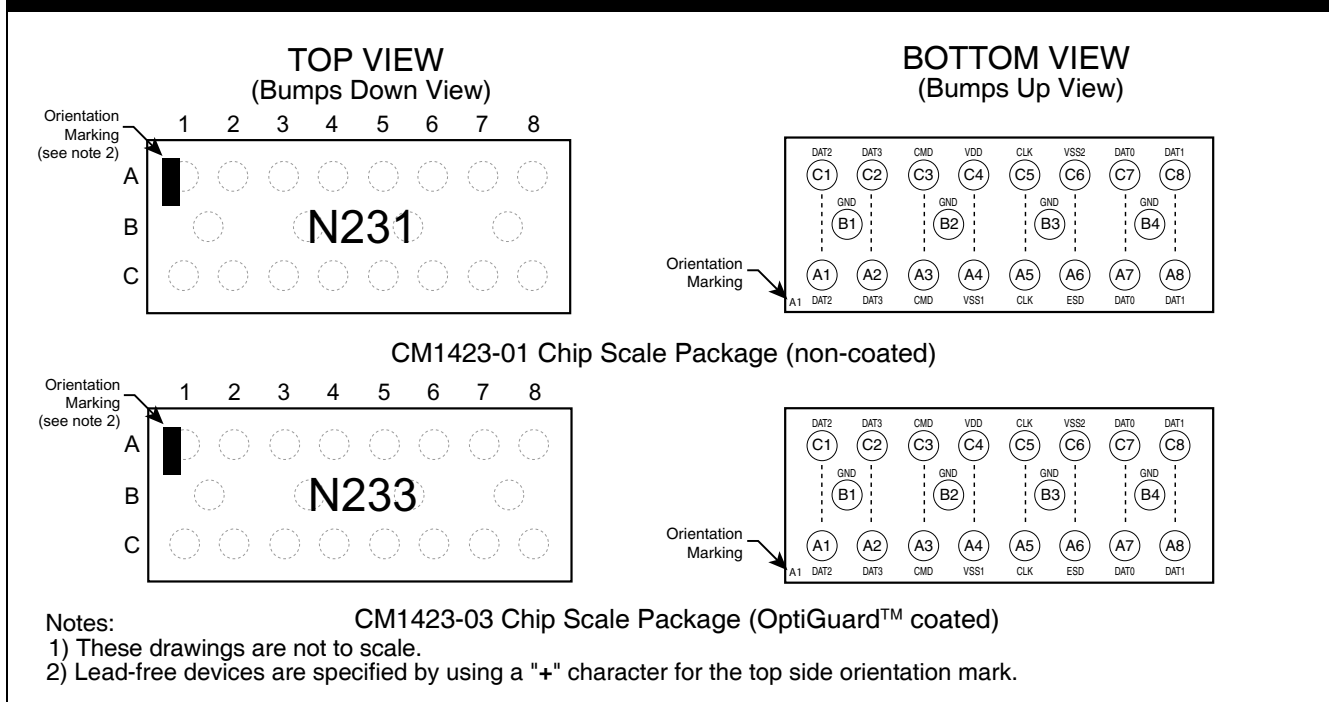
PACKAGE / PINOUT DIAGRAMS

PIN DESCRIPTIONS

PIN(s)	NAME	DESCRIPTION	PIN(s)	NAME	DESCRIPTION
A1	DAT2	DATA2 Filter+ESD Channel, System Side	C1	DAT2	DATA2 Filter+ ESD Channel, SD Card Side
A2	DAT3	DATA3 Filter+ESD Channel, System Side	C2	DAT3	DATA3 Filter+ ESD Channel, SD Card Side
A3	CMD	CMD Signal Filter+ESD Channel, System Side	C3	CMD	CMD Signal Filter+ESD Channel, SD Card Side
A4	VSS1	ESD-only Channel, Supply Voltage Ground	C4	VDD	ESD-only Channel, Supply Voltage
A5	CLK	Clock Filter + ESD Channel	C5	CLK	Clock Filter + ESD Channel
A6	ESD	ESD-only Channel	C6	VSS2	Supply Voltage Ground
A7	DAT0	DATA0 Filter+ ESD Channel, System Side	C7	DAT0	DATA0 Filter+ ESD Channel, SD Card Side
A8	DAT1	DATA1 Filter+ ESD Channel, System Side	C8	DAT1	DATA1 Filter+ ESD Channel, SD Card Side
B1-B4	GND	Device Ground			

Ordering Information
PART NUMBERING INFORMATION

Bumps	PKG	Standard Finish				Lead-free Finish ²			
		No Coating		Optiguard™ Coated		No Coating		Optiguard™ Coated	
		Ordering Part Number ¹	Part Marking	Ordering Part Number ¹	Part Marking	Ordering Part Number ¹	Part Marking	Ordering Part Number ¹	Part Marking
20	CSP	CM1423-01CS	N231	CM1423-03CS	N233	CM1423-01CP	N231	CM1423-03CP	N233

Note 1: Parts are shipped in Tape & Reel form unless otherwise specified.

Note 2: Lead-free devices are specified by using a "+" character for the top side orientation mark.

Specifications

ABSOLUTE MAXIMUM RATINGS

PARAMETER	RATING	UNITS
Storage Temperature Range	-65 to +150	°C
DC Power per Resistor	100	mW
DC Package Power Rating	500	mW

STANDARD OPERATING CONDITIONS

PARAMETER	RATING	UNITS
Operating Temperature Range	-40 to +85	°C

ELECTRICAL OPERATING CHARACTERISTICS (SEE NOTE 1)

SYMBOL	PARAMETER	CONDITIONS	MIN	TYP	MAX	UNITS
R	Resistance		80	100	120	Ω
C	Capacitance	At 2.5V DC, 1MHz, 30mV AC	9	12	15	pF
V _{DIODE}	Diode Standoff Voltage	I _{DIODE} = 10μA	5.5			V
I _{LEAK}	Diode Leakage Current (reverse bias)	V _{DIODE} = 3.3V		100		nA
V _{SIG}	Signal Voltage Positive Clamp Negative Clamp	I _{LOAD} = 10mA I _{LOAD} = -10mA	5.6 -1.5	6.8 -0.8	9.0 -0.4	V V
V _{ESD}	In-system ESD Withstand Voltage a) Human Body Model, MIL-STD-883, Method 3015 b) Contact Discharge per IEC 61000-4-2 Level 4	Notes 2,4 and 5	±30 ±15			kV kV
V _{CL}	Clamping Voltage during ESD Discharge MIL-STD-883 (Method 3015), 8kV Positive Transients Negative Transients	Notes 2,3,4 and 5		+12 -7		V V
f _C	Cut-off Frequency Z _{SOURCE} =50Ω, Z _{LOAD} =50Ω	R = 100Ω, C = 12pF; Note 5		145		MHz

Note 1: T_A=25°C unless otherwise specified.

Note 2: ESD applied to input and output pins with respect to GND, one at a time.

Note 3: Clamping voltage is measured at the opposite side of the EMI filter to the ESD pin. For example, if ESD is applied to Pin A1, then clamping voltage is measured at Pin C1.

Note 4: Unused pins are left open

Note 5: These parameters are guaranteed by design and characterization.

Performance Information

Typical Filter Performance (nominal conditions unless specified otherwise, 50 Ohm Environment)

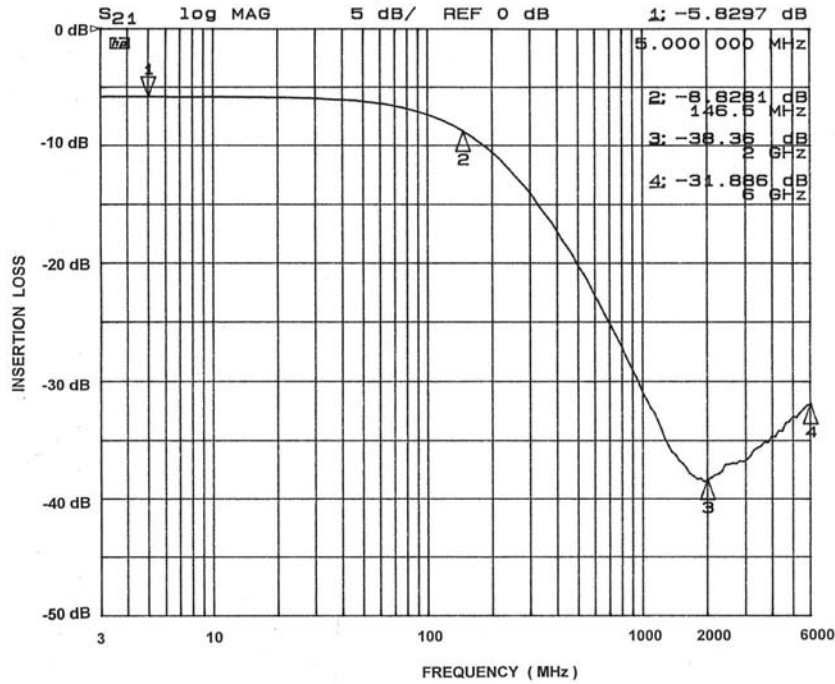

Figure 1. A1-C1 EMI Filter Performance

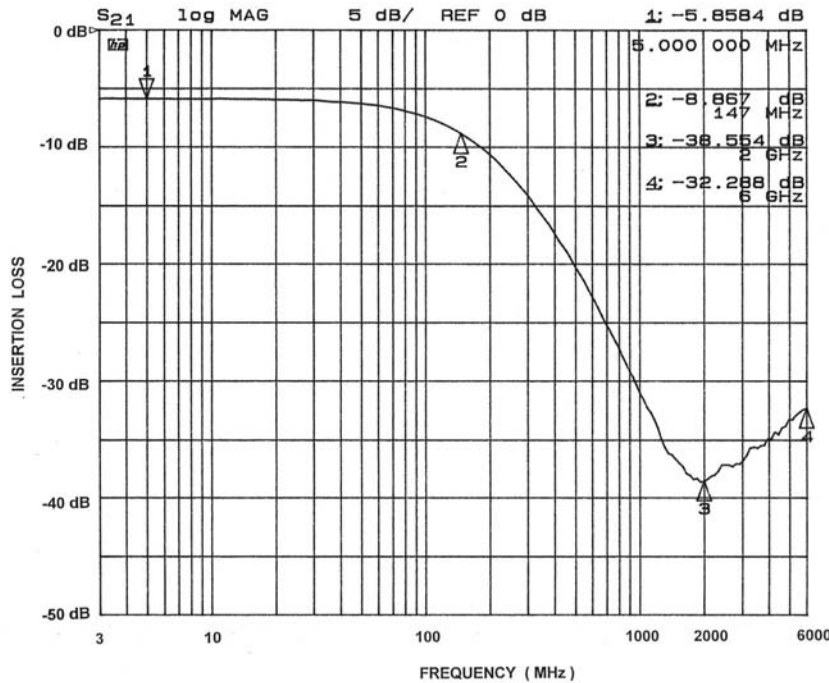

Figure 2. A2-C2 EMI Filter Performance

Performance Information (cont'd)

Typical Filter Performance (nominal conditions unless specified otherwise, 50 Ohm Environment)

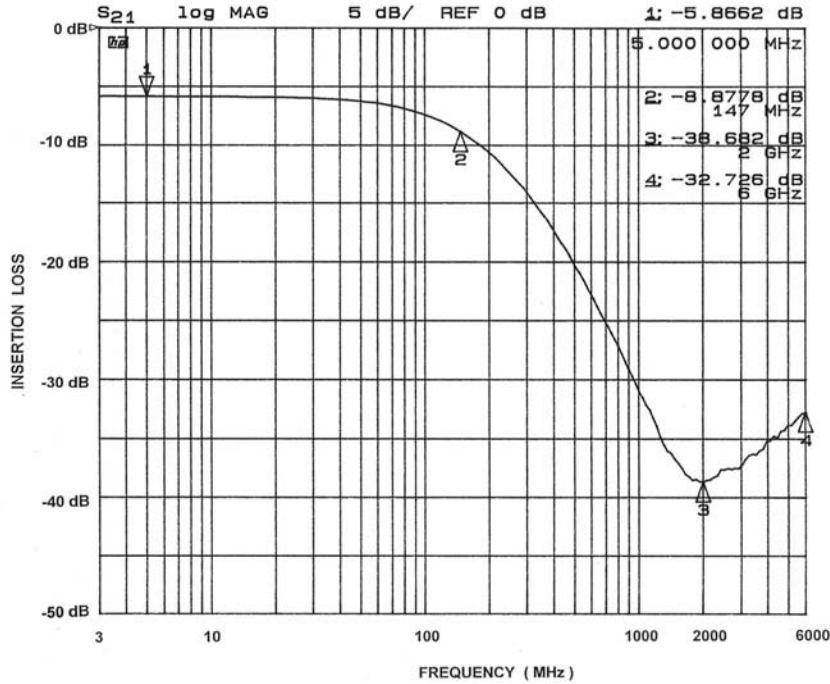

Figure 3. A3-C3 EMI Filter Performance

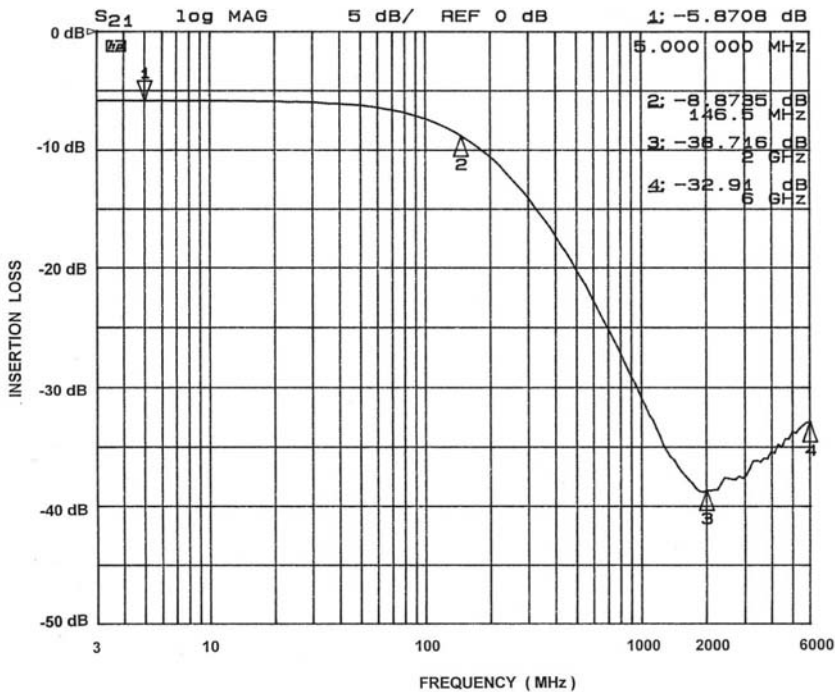

Figure 4. A5-C5 EMI Filter Performance

Performance Information (cont'd)

Typical Filter Performance (nominal conditions unless specified otherwise, 50 Ohm Environment)

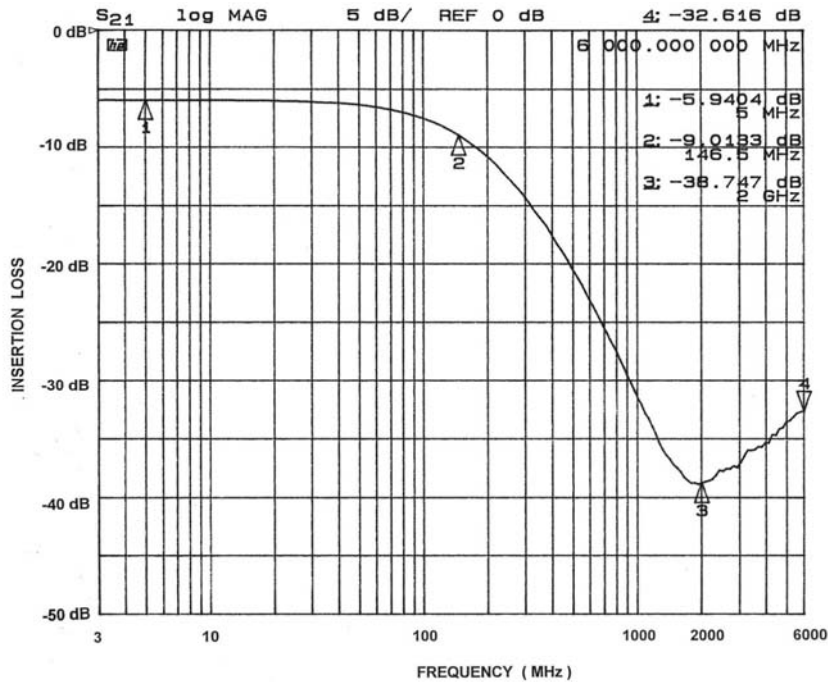

Figure 5. A7-C7 EMI Filter Performance

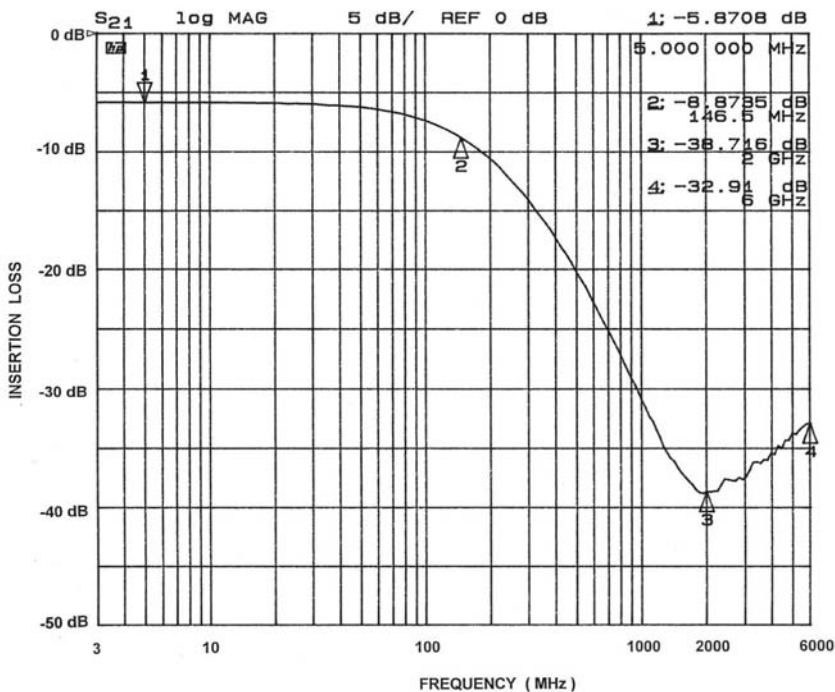
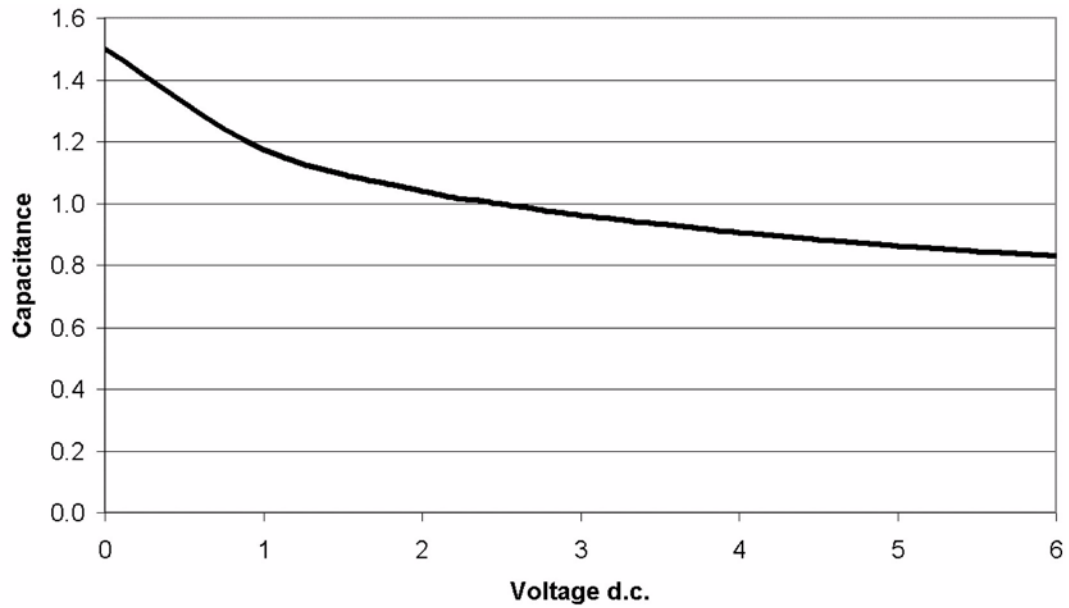

Figure 6. A8-C8 EMI Filter Performance

Performance Information



**Figure 7. Filter Capacitance vs. Input Voltage over Temperature
(normalized to capacitance at 2.5VDC and 25°C)**

Application Information

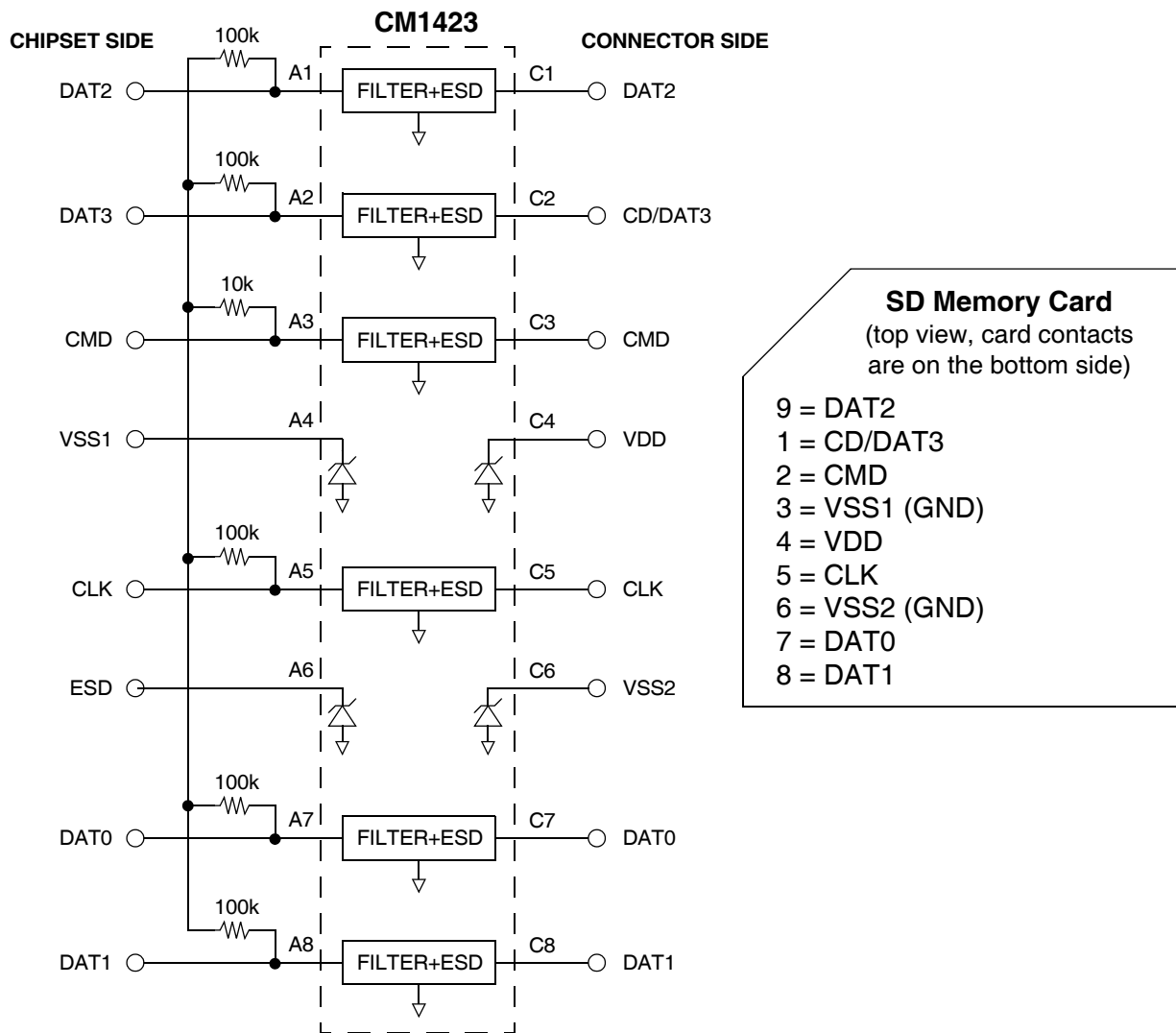

Note: 100kΩ and 10kΩ pull-up resistors are not included in CM1423. Designer will need to determine the appropriate pull-up resistor value for each design.

Figure 8. Typical SD Card Application

Application Information (cont'd)

Refer to Application Note AP-217, "The Chip Scale Package", for a detailed description of Chip Scale Packages offered by California Micro Devices.

PRINTED CIRCUIT BOARD RECOMMENDATIONS

PARAMETER	VALUE
Pad Size on PCB	0.275mm
Pad Shape	Round
Pad Definition	Non-Solder Mask defined pads
Solder Mask Opening	0.325mm Round
Solder Stencil Thickness	0.125mm - 0.150mm
Solder Stencil Aperture Opening (laser cut, 5% tapered walls)	0.330mm Round
Solder Flux Ratio	50/50 by volume
Solder Paste Type	No Clean
Pad Protective Finish	OSP (Entek Cu Plus 106A)
Tolerance — Edge To Corner Ball	$\pm 50\mu\text{m}$
Solder Ball Side Coplanarity	$\pm 20\mu\text{m}$
Maximum Dwell Time Above Liquidous	60 seconds
Soldering Maximum Temperature	260°C

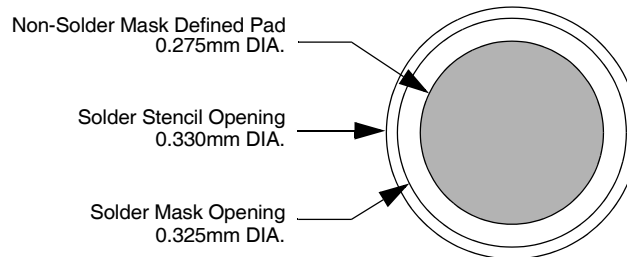

Figure 9. Recommended Non-Solder Mask Defined Pad Illustration

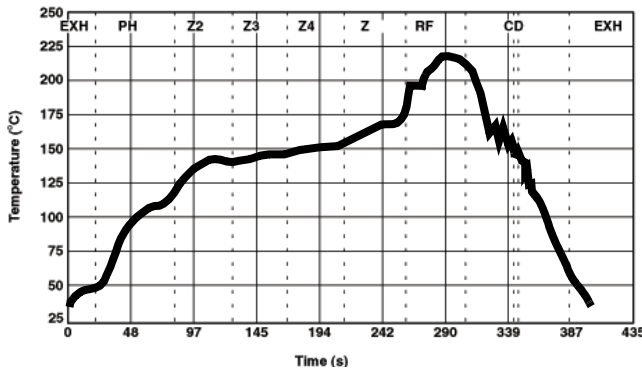

Figure 10. Eutectic (SnPb) Solder Ball Reflow Profile

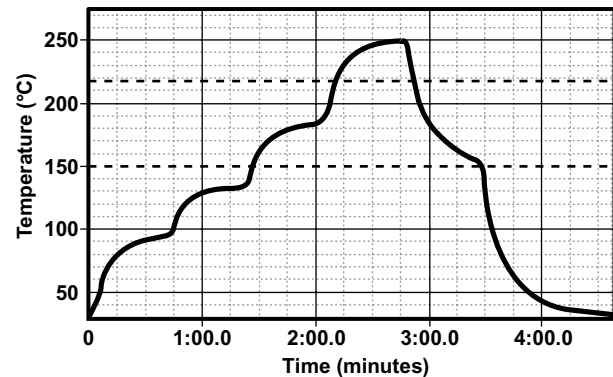

Figure 11. Lead-free (SnAgCu) Solder Ball Reflow Profile

Mechanical Details

CM1423 Mechanical Specifications

The package dimensions for the CM1423-01 and the CM1423-03 are presented below.

PACKAGE DIMENSIONS						
Package	Custom CSP					
Bumps	20					
Dim	Millimeters			Inches		
	Min	Nom	Max	Min	Nom	Max
A1	3.955	4.000	4.045	0.1557	0.1575	0.1593
A2	1.413	1.458	1.503	0.0556	0.0574	0.0592
B1	0.495	0.500	0.505	0.0195	0.0197	0.0199
B2	0.245	0.250	0.255	0.0096	0.0098	0.0100
B3	0.430	0.435	0.440	0.0169	0.0171	0.0173
B4	0.430	0.435	0.440	0.0169	0.0171	0.0173
C1	0.200	0.250	0.300	0.0079	0.0098	0.0118
C2	0.244	0.294	0.344	0.0096	0.0116	0.0135
D1	0.561	0.605	0.649	0.0221	0.0238	0.0255
D2	0.355	0.380	0.405	0.0140	0.0150	0.0159
D3	0.600	0.670	0.739	0.0236	0.0264	0.0291
D4	0.394	0.445	0.495	0.0155	0.0175	0.0195
# per tape and reel	3500 pieces					
Controlling dimension: millimeters						

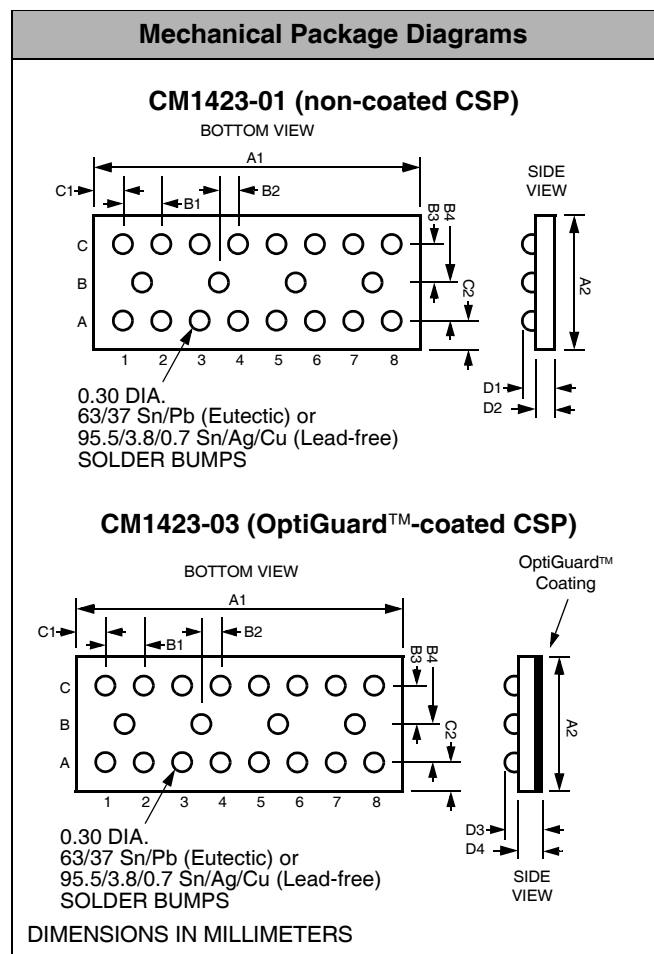

Package Dimensions for CM1423 Chip Scale Package

CSP Tape and Reel Specifications

PART NUMBER	CHIP SIZE (mm)	POCKET SIZE (mm) B ₀ X A ₀ X K ₀	TAPE WIDTH W	REEL DIAMETER	QTY PER REEL	P ₀	P ₁
CM1423-01	4.00 X 1.46 X 0.60	4.11 X 1.57 X 0.76	12mm	330mm (13")	3500	4mm	4mm
CM1423-03	4.00 X 1.46 X 0.67	4.11 X 1.57 X 0.76	12mm	330mm (13")	3500	4mm	4mm

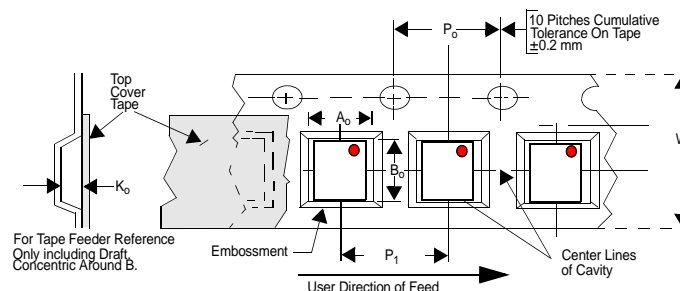

Figure 12. Tape and Reel Mechanical Data