

LOW NOISE AMPLIFIER
1800 to 2500 MHz Operation

Features

- 2.5 dB Typical Noise Figure
- +13 dBm Typical Compression Level
- 13 dB Typical Gain
- Unconditionally Stable
- 5.0 Volt Single Supply
- Internally Matched, AC Coupled
- Cascadable

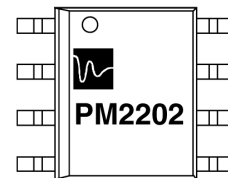

SO-8 Plastic Package

Description

The PM2202 is a GaAs RFIC low noise amplifier designed for use in applications requiring a combination of low noise and a high compression point at frequencies from 1800 through 2500 MHz. Input/output blocking capacitors are included in the device and no external matching components are required for standard operation.

Electrical Characteristics $V_{DD}=5.0V$, $T_A = +25^{\circ}C$, $Z_0=50\ \Omega$

Characteristics	Symbol	Conditions	Min	Typ	Max	Units
Frequency Range	F		1800		2500	MHz
Small Signal Gain	G	$P_{IN} = -30\text{ dBm}$	12.0	13.0		dB
Gain Flatness	ΔG			1.0		dB
Input Return Loss	S11			10.0		dB
Output Return Loss	S22			13.0		dB
Power Output	P_{-1dB}			13.0		dBm
Noise Figure	NF			2.5	2.8	dB
Harmonics	-	@ P_{-1dB} Compression		-20		dBc
Third-Order Intercept Point	IP_3	1 MHz Tone Spacing		24		dBm
Supply Voltage	V_{DD}			5.0		V
Supply Current	I_{DD}			35	45	mA
Thermal Resistance	θ_{JC}	$T=85^{\circ}C$, $P_{DISS} = 1.9W$		70		$^{\circ}C/W$

Absolute Maximum Ratings*

Characteristics	Symbol	Value	Units
DC Drain Voltage	V_{DD}	+10.0	V
RF Input Power	P_{IN}	+20.0	dBm
Operating Baseplate Temperature	T_{OP}	-40 to +85	$^{\circ}C$
Junction Temperature	T_J	+150	$^{\circ}C$
Storage Temperature Range	T_{STG}	-65 to +150	$^{\circ}C$

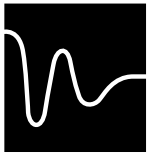

TYPICAL CHARACTERISTICS

PM2202 Gain, Noise Figure, and Stability Factor

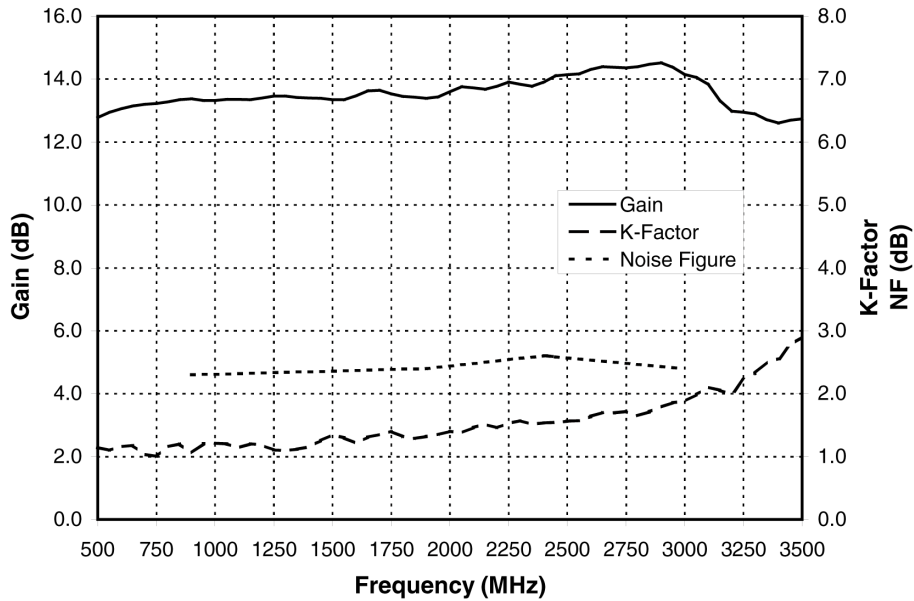

PM2202 Return Loss and Isolation

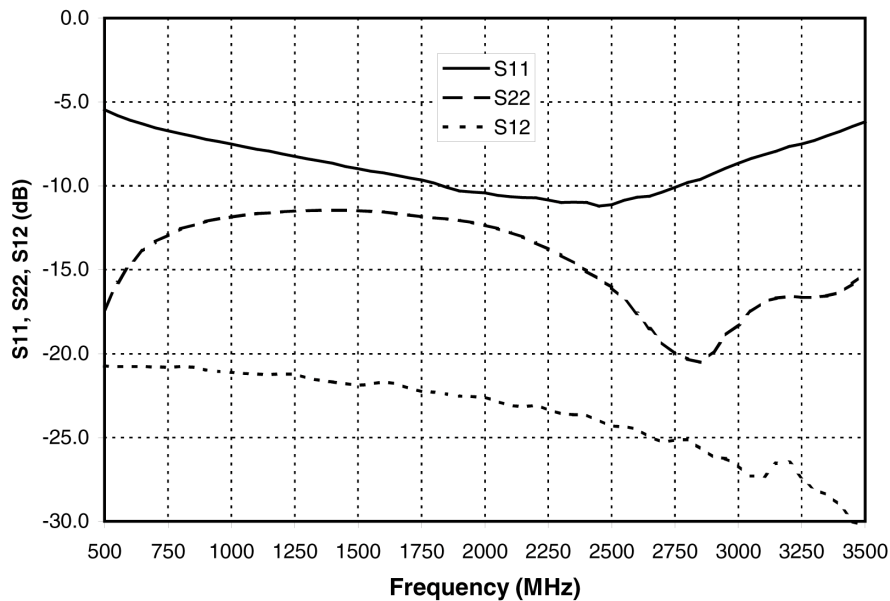

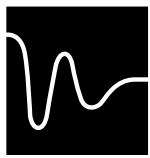

TYPICAL CHARACTERISTICS

Scattering Parameters, $V_{DD} = 5.0V$, $T_A = +25^\circ C$, 50Ω System

FREQ (MHz)	S ₁₁		S ₂₁		S ₁₂		S ₂₂		S ₂₁	K Factor
	MAG	ANG	MAG	ANG	MAG	ANG	MAG	ANG	(dB)	
500	0.533	-40.6	4.354	-144.1	0.092	42.7	0.135	61.4	12.78	1.15
600	0.496	-41.3	4.499	-155.8	0.091	36.2	0.185	43.5	13.06	1.16
700	0.471	-42.6	4.570	-165.0	0.091	32.1	0.216	34.4	13.20	1.04
800	0.452	-44.4	4.613	-172.3	0.092	29.1	0.235	29.0	13.28	1.16
900	0.435	-46.5	4.658	-179.1	0.089	26.4	0.248	24.9	13.36	1.06
1000	0.421	-49.0	4.636	175.4	0.088	25.7	0.255	21.8	13.32	1.21
1100	0.407	-51.6	4.653	170.3	0.087	24.7	0.261	19.2	13.36	1.14
1200	0.393	-54.6	4.680	166.0	0.087	24.2	0.265	16.8	13.40	1.19
1300	0.380	-57.4	4.707	160.9	0.085	22.6	0.267	15.1	13.46	1.10
1400	0.369	-60.6	4.680	156.9	0.082	22.8	0.268	13.4	13.40	1.16
1500	0.356	-63.9	4.649	152.8	0.080	23.7	0.267	11.7	13.35	1.35
1600	0.346	-67.3	4.715	150.4	0.082	23.7	0.264	10.1	13.47	1.22
1700	0.334	-70.8	4.807	145.0	0.079	21.6	0.259	8.6	13.64	1.36
1800	0.323	-75.2	4.705	141.1	0.077	22.7	0.254	7.7	13.45	1.31
1900	0.305	-77.6	4.671	138.0	0.075	23.2	0.250	6.4	13.39	1.32
2000	0.301	-80.6	4.787	135.6	0.074	23.0	0.241	4.9	13.60	1.40
2100	0.294	-84.2	4.852	130.6	0.070	23.2	0.230	3.7	13.72	1.46
2200	0.291	-88.3	4.885	127.4	0.070	23.7	0.214	2.4	13.78	1.46
2300	0.282	-91.8	4.916	122.5	0.066	23.8	0.196	2.1	13.83	1.57
2400	0.282	-96.1	4.955	119.7	0.066	23.9	0.176	2.5	13.90	1.53
2500	0.278	-97.3	5.091	114.9	0.061	24.2	0.158	3.9	14.14	1.56
2600	0.293	-101.6	5.192	110.4	0.060	23.9	0.132	7.1	14.31	1.64
2700	0.303	-105.5	5.233	103.9	0.055	26.4	0.108	16.8	14.38	1.69
2800	0.324	-110.0	5.243	98.9	0.055	26.1	0.096	34.6	14.39	1.65
2900	0.344	-114.4	5.316	92.0	0.049	26.2	0.101	55.4	14.51	1.79
3000	0.369	-120.6	5.097	85.4	0.046	27.7	0.122	63.6	14.15	1.88
3100	0.392	-126.8	4.918	78.0	0.043	36.2	0.143	67.4	13.84	2.10
3200	0.414	-132.5	4.460	74.6	0.047	31.6	0.148	70.1	12.99	1.99
3300	0.431	-137.3	4.414	71.8	0.039	30.8	0.147	76.3	12.90	2.33
3400	0.459	-142.1	4.270	68.1	0.035	32.5	0.152	85.7	12.61	2.56
3500	0.490	-146.3	4.335	62.5	0.031	45.5	0.174	94.4	12.74	2.91

PACKAGE SPECIFICATIONS

Package Dimensions

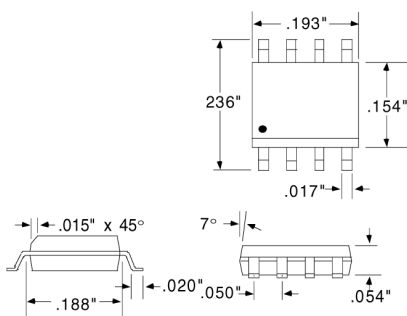

Mounting Pad Dimensions

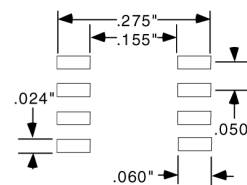

Typical Application Schematic

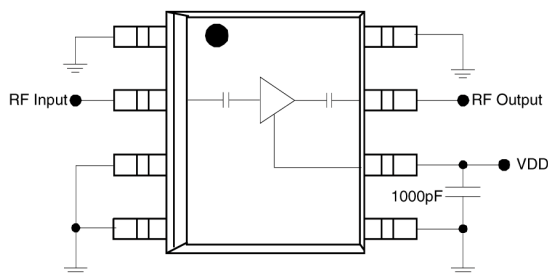

Pin Connections

Pin Number	Function
1	GND
2	RF _{IN}
3,4,5	GND
6	V _{DD}
7	RF _{OUT}
8	GND

Matching Requirements

The PM2202 is internally matched to 50Ω for the 1800 to 2500 MHz frequency range. A 1000pF capacitor is required for decoupling. The external match of the LNA can be optimized for operating at lower frequencies by introducing a series inductor at the RF Input. Consult the factory for more details.