

## FSAL200

### Wide Bandwidth Quad 2:1 Analog Multiplexer/Demultiplexer Switch

#### General Description

The Fairchild Switch FSAL200 is a rail-to-rail quad 2:1 high-speed CMOS TTL-compatible analog multiplexer/demultiplexer switch. The low On Resistance of the switch allows inputs to be connected to outputs without adding propagation delay or generating additional ground bounce noise.

When  $\overline{OE}$  is LOW, the select pin connects the A Port to the selected B Port output. When  $\overline{OE}$  is HIGH, the switch is OPEN and a high-impedance state exists between the two ports.

#### Features

- Typical 6Ω switch connection between two ports
- Minimal propagation delay through the switch
- Low  $I_{CC}$
- Zero bounce in flow-through mode
- Control inputs compatible with TTL level
- Rail-to-rail signal handling
- Low insertion loss
- Route communications signals including:
  - 10/100 Ethernet
  - USB1.1
  - 100VG-AnyLAN
  - Token Ring 4/16 Mbps
  - ATM25
  - SONET OCI 51.8 Mbps
  - T1/E1

#### Ordering Code:

Order Number	Package Number	Package Description
FSAL200QSC	MQA16	16-Lead Quarter Size Outline Package (QSOP), JEDEC MO-137, 0.150" Wide

Device also available in Tape and Reel. Specify by appending suffix letter "X" to the ordering code.

#### Analog Symbol

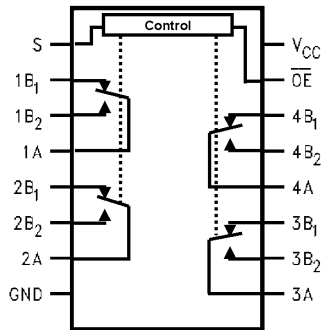

#### Connection Diagram

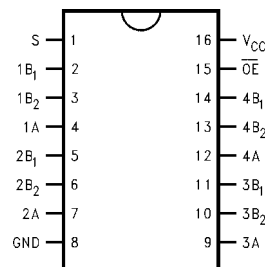

#### Truth Table

S	$\overline{OE}$	Function
X	H	Disconnect
L	L	A = B <sub>1</sub>
H	L	A = B <sub>2</sub>

#### Pin Descriptions

Pin Name	Description
$\overline{OE}$	Switch Enable
S	Select Input
A, B <sub>1</sub> , B <sub>2</sub>	Data Port

**Absolute Maximum Ratings** (Note 1)

Supply Voltage ( $V_{CC}$ )	-0.5V to +7.0V
DC Switch Voltage ( $V_S$ ) (Note 2)	-0.5V to $V_{CC}$ +0.5V
DC Input Voltage ( $V_{IN}$ ) (Note 2)	-0.5V to +7.0V
DC Input Diode Current ( $I_{IK}$ ) @ ( $I_{IK}$ ) $V_{IN} < 0V$	-50 mA
DC Output Current ( $I_{OUT}$ )	120 mA
DC $V_{CC}$ or Ground Current ( $I_{CC}/I_{GND}$ )	$\pm 100$ mA
Storage Temperature Range ( $T_{STG}$ )	-65°C to +150°C
Power Dissipation ( $P_D$ ) @ +85°C	0.5 W
Ambient Temperature with Power Applied	-40°C to +85°C

**Recommended Operating Conditions** (Note 3)

Supply Voltage Operating ( $V_{CC}$ )	3.0V to 5.5V
Control Input Voltage ( $V_{IN}$ )	0V to $V_{CC}$
Switch Input Voltage ( $V_{IN}$ )	0V to $V_{CC}$
Output Voltage ( $V_{OUT}$ )	0V to $V_{CC}$
Operating Temperature ( $T_A$ )	-40°C to +85°C
Input Rise and Fall Time ( $t_r, t_f$ )	
Control Input $V_{CC} = 2.3V - 3.6V$	0 ns/V to 10 ns/V
Control Input $V_{CC} = 4.5V - 5.5V$	0 ns/V to 5 ns/V
Thermal Resistance ( $\theta_{JA}$ )	350°C/W

**Note 1:** Absolute maximum ratings are DC values beyond which the device may be damaged or have its useful life impaired. The datasheet specifications should be met, without exception, to ensure that the system design is reliable over its power supply, temperature, and output/input loading variables. Fairchild does not recommend operation outside datasheet specifications.

**Note 2:** The input and output negative voltage ratings may be exceeded if the input and output diode current ratings are observed.

**Note 3:** Control input must be held HIGH or LOW, it must not float.

**DC Electrical Characteristics**

Symbol	Parameter	$V_{CC}$ (V)	$T_A = -40^\circ\text{C to } +85^\circ\text{C}$			Units	Conditions
			Min	Typ	Max		
$V_{IH}$	HIGH Level Input Voltage	4.5 - 5.5 3.0 - 3.6	2.0 2.0			V	
$V_{IL}$	LOW Level Input Voltage	4.5 - 5.5 3.0 - 3.6	-0.5 -0.5		0.8 0.8	V	
$I_{OZ}$	OFF State Leakage Current	0 - 5.5			100	nA	$0 \leq V_{IN} \leq 5.5V$
$R_{ON}$	Switch On Resistance (Note 4)	4.5 - 5.5 3.0 - 3.6		6 15	12 22	$\Omega$	$I_{ON} = 10 - 30$ mA $I_{ON} = 10 - 30$ mA
$I_{IN}$	Control Input Leakage Current	5.5 3.6			$\pm 1$ $\pm 1$	$\mu A$	$V_{IN} = V_{CC}$ or GND $V_{IN} = V_{CC}$ or GND
$I_{CC}$	Quiescent Supply Current All Channels ON or OFF	5.5			1	$\mu A$	$V_{IN} = V_{CC}$ or GND $I_{OUT} = 0$
	Analog Signal Range	$V_{CC}$	0		$V_{CC}$	V	
$\Delta R_{ON}$	On Resistance Match Between Channels (Note 4)(Note 5)	4.5 - 5.5 3.0 - 3.6		0.4 1	2 3	$\Omega$	$I_A = -30$ mA, $V_{Bn} = 3.15$ $I_A = -10$ mA, $V_{Bn} = 2.1$
$I_O$	Output Current	4.5 - 5.5 3.0 - 3.6	100 80			mA	$B_n, B_{n'}, S = 0V$ to 5V
$R_{flat}$	On Resistance Flatness (Note 4)(Note 6)	4.5 - 5.5 3.0 - 3.6		3 7		$\Omega$	A, $B_1, B_2 = 0V$ to 5V A, $B_1, B_2 = 0V$ to 5V

**Note 4:** Measured by the voltage drop between A and B pins at the indicated current through the switch. On Resistance is determined by the lower of the voltages on the two (A or B Ports).

**Note 5:**  $\Delta R_{ON} = R_{ON} \text{ max} - R_{ON} \text{ min}$  measured at identical  $V_{CC}$ , temperature and voltage levels.

**Note 6:** Flatness is defined as the difference between the maximum and minimum value of On Resistance over the specified range of conditions.

AC Electrical Characteristics																																										
Symbol	Parameter	V <sub>CC</sub> (V)	T <sub>A</sub> = -40°C to +85°C			Units	Conditions	Figure Number																																		
			Min	Typ	Max																																					
t <sub>ON</sub>	Turn On Time S to Output	4.5 - 5.5		10	20	ns	V <sub>Bn</sub> = 3V	Figures 1, 2																																		
		3.0 - 3.6		28	40	ns	V <sub>Bn</sub> = 1.5V																																			
t <sub>OFF</sub>	Turn Off Time S to Output	4.5 - 5.5		5	10	ns	V <sub>Bn</sub> = 3V	Figures 1, 2																																		
		3.0 - 3.6		4	20	ns	V <sub>Bn</sub> = 1.5V																																			
Q	Charge Injection (Note 7)	5.0		7		pC	C <sub>L</sub> = 0.1 nF, V <sub>GEN</sub> = 0V R <sub>GEN</sub> = 0 Ω	Figure 3																																		
		3.3		3																																						
OIRR	Off Isolation (Note 8)	4.5 - 5.5		-55		dB	R <sub>L</sub> = 100 Ω f = 30 MHz	Figure 4																																		
		3.0 - 3.6		-75					R <sub>L</sub> = 50 Ω f = 1 MHz	Figure 4																																
Xtalk	Crosstalk	4.5 - 5.5		-70		dB	R <sub>L</sub> = 100 Ω f = 30 MHz	Figure 5																																		
		3.0 - 3.6		-75					R <sub>L</sub> = 50 Ω f = 1 MHz	Figure 5																																
BW	-3dB Bandwidth	4.5 - 5.5		137		MHz	R <sub>L</sub> = 100 Ω	Figure 8																																		
		3.0 - 3.6		110					R <sub>L</sub> = 50 Ω	Figure 8																																
D	ΔR <sub>ON/RL</sub> Distortion (Note 7)	4.5 - 5.5		2		%	R <sub>L</sub> = 100 Ω																																			
		3.0 - 3.6		3																																						
<p><b>Note 7:</b> Guaranteed by Design.</p> <p><b>Note 8:</b> Off Isolation = 20 log<sub>10</sub> [V<sub>A</sub> / V<sub>Bn</sub>]</p>																																										
<h3>Capacitance (Note 9)</h3> <table border="1"> <thead> <tr> <th>Symbol</th> <th>Parameter</th> <th>Typ</th> <th>Max</th> <th>Units</th> <th>Conditions</th> <th>Figure Number</th> </tr> </thead> <tbody> <tr> <td>C<sub>IN</sub></td> <td>Control Pin Input Capacitance</td> <td>2.3</td> <td></td> <td>pF</td> <td>V<sub>CC</sub> = 0V</td> <td></td> </tr> <tr> <td rowspan="2">C<sub>IO-B</sub></td> <td>B Port Off Capacitance</td> <td>12</td> <td></td> <td>pF</td> <td>V<sub>CC</sub> = 5.0V and 3.0V</td> <td>Figure 6</td> </tr> <tr> <td>A Port Off Capacitance</td> <td>20</td> <td></td> <td>pF</td> <td>V<sub>CC</sub> = 5.0V and 3.0V</td> <td>Figure 7</td> </tr> <tr> <td>C<sub>ON</sub></td> <td>Channel On Capacitance</td> <td>15</td> <td></td> <td>pF</td> <td>V<sub>CC</sub> = 5.0V and 3.0V</td> <td>Figure 7</td> </tr> </tbody> </table> <p><b>Note 9:</b> T<sub>A</sub> = +25°C, f = 1 MHz, Capacitance is characterized but not tested in production.</p>									Symbol	Parameter	Typ	Max	Units	Conditions	Figure Number	C <sub>IN</sub>	Control Pin Input Capacitance	2.3		pF	V <sub>CC</sub> = 0V		C <sub>IO-B</sub>	B Port Off Capacitance	12		pF	V <sub>CC</sub> = 5.0V and 3.0V	Figure 6	A Port Off Capacitance	20		pF	V <sub>CC</sub> = 5.0V and 3.0V	Figure 7	C <sub>ON</sub>	Channel On Capacitance	15		pF	V <sub>CC</sub> = 5.0V and 3.0V	Figure 7
Symbol	Parameter	Typ	Max	Units	Conditions	Figure Number																																				
C <sub>IN</sub>	Control Pin Input Capacitance	2.3		pF	V <sub>CC</sub> = 0V																																					
C <sub>IO-B</sub>	B Port Off Capacitance	12		pF	V <sub>CC</sub> = 5.0V and 3.0V	Figure 6																																				
	A Port Off Capacitance	20		pF	V <sub>CC</sub> = 5.0V and 3.0V	Figure 7																																				
C <sub>ON</sub>	Channel On Capacitance	15		pF	V <sub>CC</sub> = 5.0V and 3.0V	Figure 7																																				

## AC Loading and Waveforms

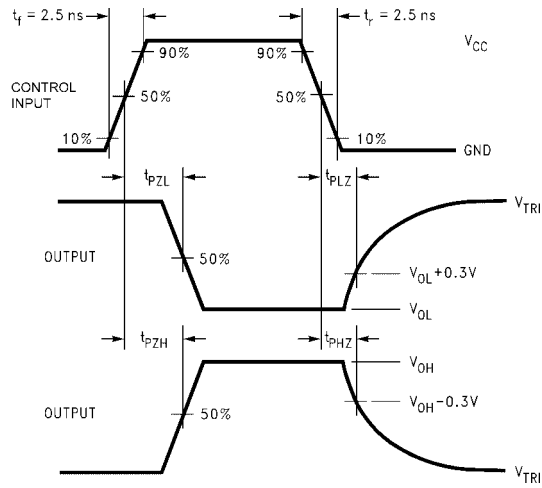

FIGURE 1. AC Waveforms

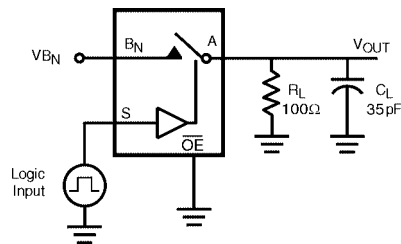

FIGURE 2.  $t_{ON}$ ,  $t_{OFF}$  Loading

AC Loading and Waveforms (Continued)

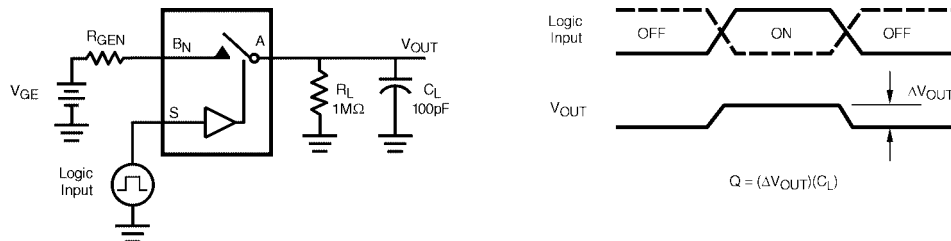

FIGURE 3. Charge Injection Test

Note:  $R_L = 50 \Omega$  when  $V_{CC} = 3.3 \pm 10\%$  for the Off Isolation, Crosstalk and Bandwidth test.

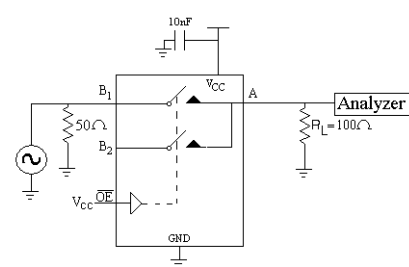

FIGURE 4. Off Isolation

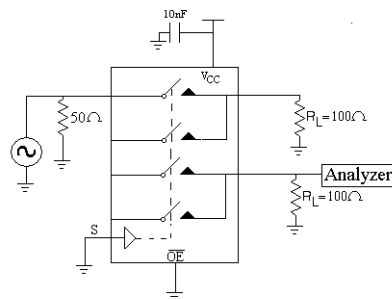

FIGURE 5. Crosstalk

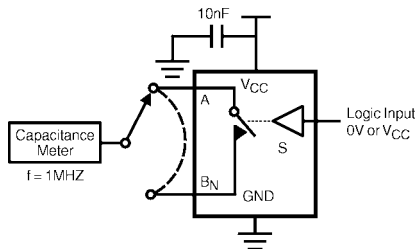

FIGURE 6. Channel Off Capacitance

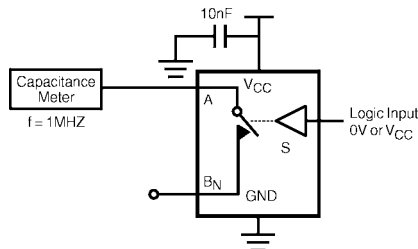

FIGURE 7. Channel On Capacitance

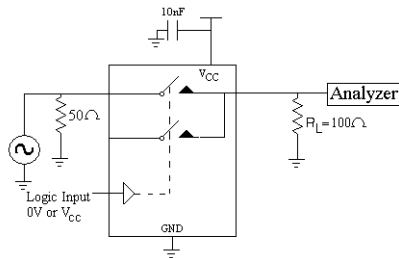

FIGURE 8. Bandwidth

