

## 10 Watt GaAs Wide Band SPDT Switch

### Features:

- ◆ 3x3x0.9mm Packaged pHEMT Switch
- ◆ Ideal for WiMax, L, S, and C-band digital cellular, and WLAN applications
- ◆ High isolation, 36dB typ at 3.5GHz
- ◆ Low insertion loss, 0.5dB typ at 2.5GHz
- ◆ Low insertion loss, 0.96dB typ at 6GHz
- ◆ P1dB 42dBm at 5GHz
- ◆ Operates from a single positive voltage
- ◆ Less than 10 $\mu$ A control current at 35dBm input power
- ◆ RoHS compliant

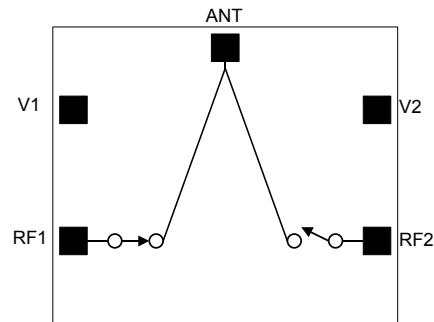

**Functional Schematic**

### Description and Applications:

The FMS2031-001 is a 10 Watt, low loss, and single pole dual throw Gallium Arsenide antenna switch. The die is fabricated using the Filtronic FL05 0.5 $\mu$ m switch process technology, which offers leading edge performance optimised for switch applications. The FMS2031-001 is designed for use in WiMax, L, S, and C band wireless applications and WLAN access points where high linearity switching is required.

### Absolute Maximum Ratings:

Parameter	Symbol	Absolute Maximum
Max Input Power	Pin	+42dBm
Control Voltage	V ctrl	+6V
Operating Temperature	T oper	-40°C to +100°C
Storage Temperature	T stor	-55°C to +150°C

**Note:** Exceeding any one of these absolute maximum ratings may cause permanent damage to the device.

### Truth Table:

Switch State	VC1	VC2	ANT- RF1	ANT- RF2
(A)	HIGH	LOW	Insertion Loss	Isolation
(B)	LOW	HIGH	Isolation	Insertion Loss

### General Test Conditions:

**Note:** External DC blocking capacitors are required on all RF ports (typ: 9pF)  
 All unused ports terminated in 50 $\Omega$ .  
 High +2.7V to +6V  
 Low +0V to +0.2V

**Electrical Specifications:** ( $T_{\text{AMBIENT}} = 25^{\circ}\text{C}$ ,  $V_{\text{ctrl}} = 0\text{V}/2.7\text{V}$ ,  $Z_{\text{IN}} = Z_{\text{OUT}} = 50\Omega$ )

Parameter	Test Conditions	Min	Typ	Max	Units
Insertion Loss	2.3 – 2.7 GHz		0.5	0.6	dB
	3.3 – 3.8 GHz		0.55	0.7	
	4.9 – 5.9 GHz		0.9		
Return Loss	2.3 – 2.7 GHz		27.5		dB
	3.3 – 3.8 GHz		21.5		
	4.9 – 5.9 GHz		>tba		
Isolation	2.3 – 2.7 GHz	30	32.5		dB
	3.3 – 3.8 GHz	30	35		
	4.9 – 5.9 GHz		23		
Input power at 0.1dB compression point	2.3 – 2.7 GHz		39.5		dBm
	3.3 – 3.8 GHz		38.5		
	4.9 – 5.9 GHz		38		
Input power at 0.5dB compression point	2.3 – 2.7 GHz		41		dBm
	3.3 – 3.8 GHz		41		
	4.9 – 5.9 GHz		41		
EVM (Contribution due to Switch)	35dBm at 5.9GHz (OFDM WLAN 54)		$\Delta$ 0.5		%
IP3	+15dBm 1980MHz		65		dB
	+15dBm 1940MHz				
Switching speed : T rise, T fall	10% to 90% RF and 90% to 10% RF		<300		ns
	T on, T off	50% control to 90% RF and 50% control to 10% RF		<800	ns
Control Current	+35dBm RF input @0.96GHz		<5	10	$\mu\text{A}$

**Typical Measured Performance on Evaluation Board (De-Embedded):**

(Measurement Conditions  $V_{CTRL} = 2.7V$  (high) &  $0V$  (low),  $T_{AMBIENT} = 25^{\circ}C$  unless otherwise stated)

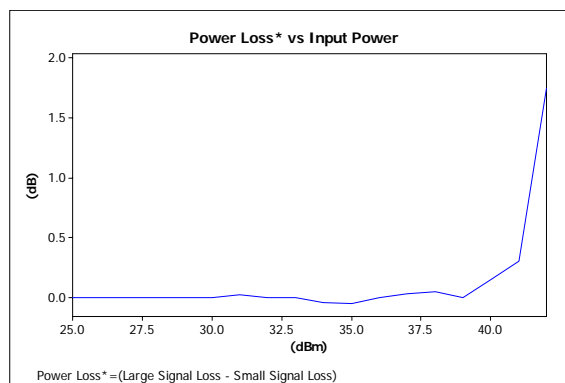
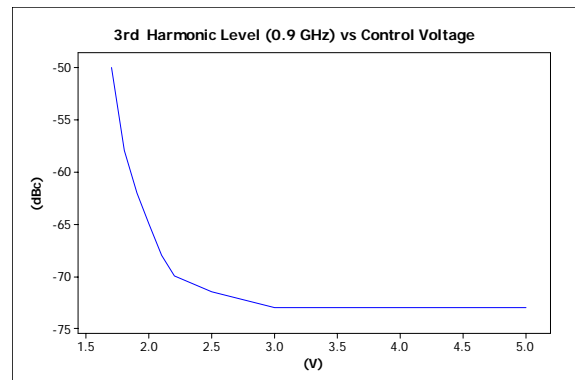
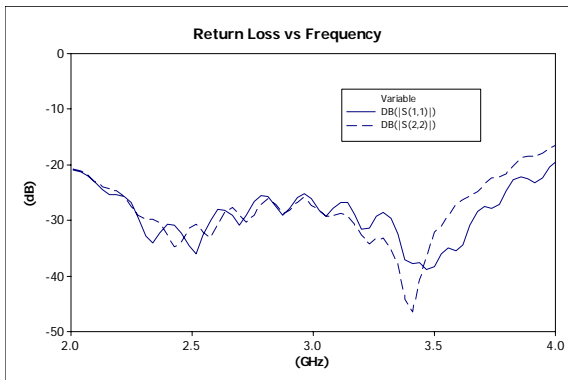
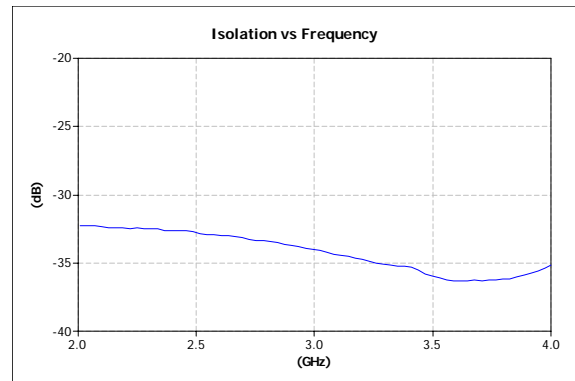
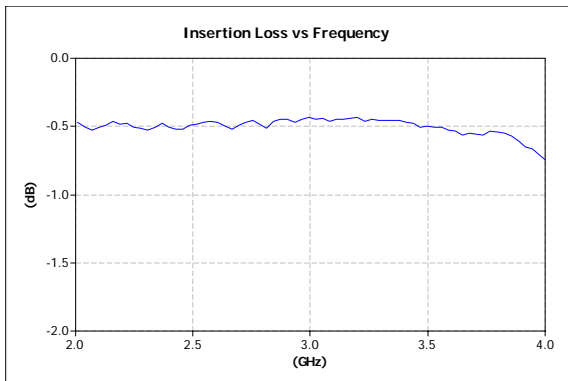

**Pad Layout:**

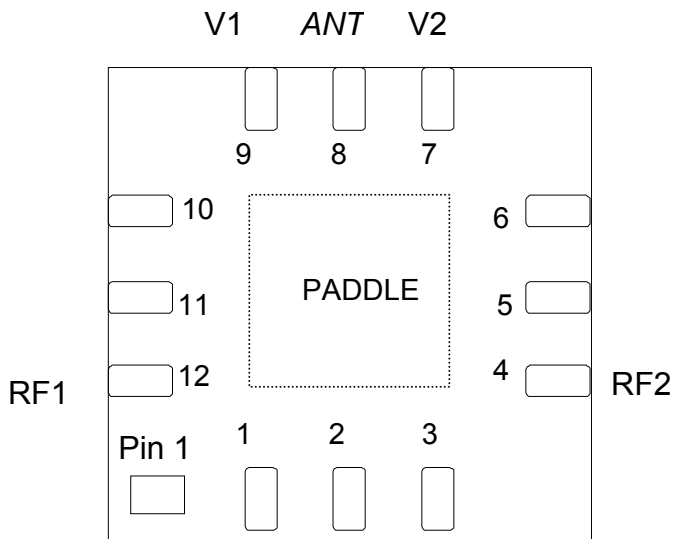

Pin Number	Description
1	N/C
2	N/C
3	N/C
4	RF2
5	N/C
6	N/C
7	V2
8	ANT RF
9	V1
10	N/C
11	N/C
12	RF1
PADDLE	GND

\*View from the top of the package

**QFN 12 Lead 3x3 Package Outline:**

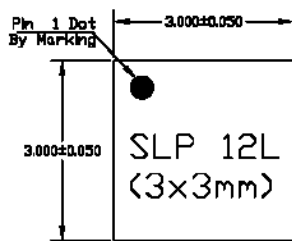

Top View

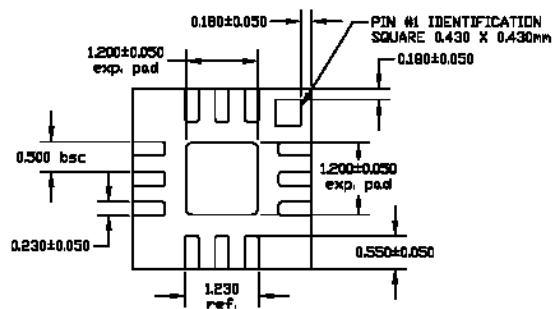

Btm View

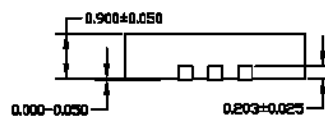

Side View

Specifications subject to change without notice

**Filtron Compound Semiconductors Ltd**

Tel: +44 (0) 1325 301111

Fax: +44 (0) 1325 306177

Email: sales@filcs.com

Website: [www.filtronic.com](http://www.filtronic.com)

**Evaluation Board:**

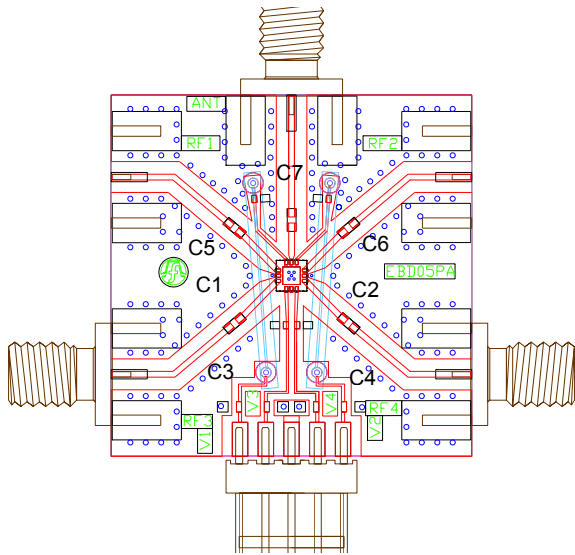

BOM	
Label	Component
C3,C4	Capacitor, 470pF, 0603
C1,C2,C7	Capacitor, 9pF, 0402
C5,C6	Capacitor, 47pF, 0402
BOARD	Preferred evaluation board material is 0.25 mm thick ROGERS RT4350. All RF tracks should be 50 ohm characteristic impedance.

**Evaluation Board De-Embedding Data (Measured):**

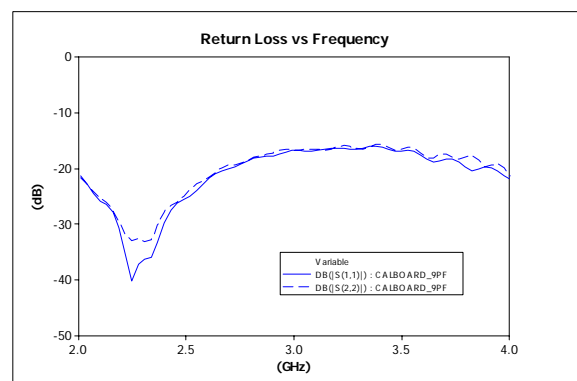
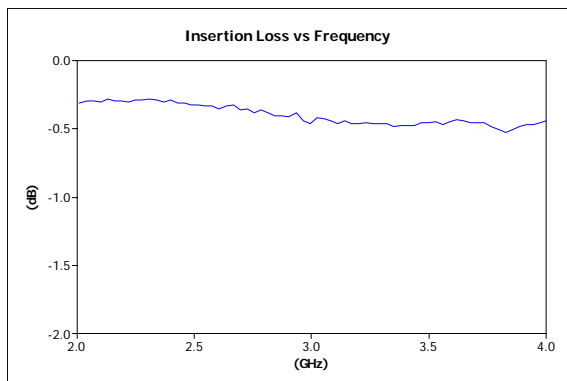

Specifications subject to change without notice  
**Filtronic Compound Semiconductors Ltd**

Tel: +44 (0) 1325 301111

Fax: +44 (0) 1325 306177

Email: [sales@filcs.com](mailto:sales@filcs.com)

Website: [www.filtronic.com](http://www.filtronic.com)

**Tape & Reel Specification:**

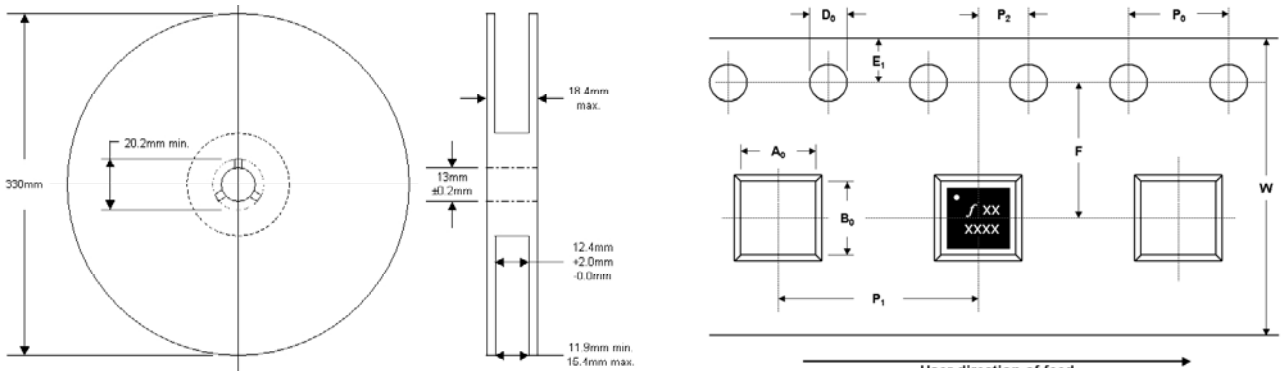

Tape Dimensions	Description	Symbol	Size (mm)
Perforation	Diameter	D0	1.5 ±0.1
	Pitch	P0	4.0 ±0.1
	Position	E1	1.75 ±0.1
Cavity	Length	A0	3.3 ±0.1
	Width	B0	3.3 ±0.1
	Depth	K	1.1 ±0.1
Distance between centre lines	Cavity to Perforation (length direction)	P2	2.0 ±0.1
	Cavity to Perforation (width direction)	F	5.5 ±0.1
Carrier tape	Width	W	12 ±0.3

Specifications subject to change without notice  
**Filtronic Compound Semiconductors Ltd**

Tel: +44 (0) 1325 301111

Fax: +44 (0) 1325 306177

Email: sales@filcs.com

Website: [www.filtronic.com](http://www.filtronic.com)

**Preferred Assembly Instructions:**

Available on request.

**Disclaimers:**

This product is not designed for use in any space based or life sustaining/supporting equipment.

**Handling Precautions:**

To avoid damage to the devices care should be exercised during handling. Proper Electrostatic Discharge (ESD) precautions should be observed at all stages of storage, handling, assembly, and testing. These devices should be treated as Class 1A (250-500 V) as defined in JEDEC Standard No. 22-A114. Further information on ESD control measures can be found in MIL-STD-1686 and MIL-HDBK-263.

**Application Notes & Design Data:**

Application Notes and design data, including S-parameters, are available on request.

**Disclaimers:**

This product is not designed for use in any space based or life sustaining/supporting equipment.

**Ordering Information:**

Part Number	Description
FMS2031-001-TR	Packaged Die Tape & Reel (minimum quantity: 1k pcs)
FMS2031-001-TB	Packaged Die supplied in a Tube
FMS2031-001-EB	Packaged Die mounted on Evaluation Board

*Specifications subject to change without notice*

**Filtron Compound Semiconductors Ltd**

Tel: +44 (0) 1325 301111

Fax: +44 (0) 1325 306177

Email: [sales@filcs.com](mailto:sales@filcs.com)

Website: [www.filtronic.com](http://www.filtronic.com)