

GENERAL DESCRIPTION

The CM8500 is a switching regulator designed to provide a desired output voltage or termination voltage for various applications by converting voltage supplies ranging from 2.0V to 4.0V. The CM8500 can be implemented to produce regulated output voltages in two different modes. In the default mode, when the VIN/2 pin is open, the output voltage is 50% of the VCCQ. The CM8500 can also be used to produce various user-defined voltages by forcing a voltage on the VIN/2 pin. In this case, the output voltage follows the VIN/2 pin input voltage. The switching regulator is capable of sourcing or sinking up to 3A of current while regulating an output V_{TT} voltage to within 3% or less.

The CM8500, used in conjunction with series termination resistors, provides an excellent voltage source for active termination schemes of high speed transmission lines as those seen in high speed memory buses and distributed backplane designs.

The voltage output of the regulator can be used as a termination voltage for other bus interface standards such as SSTL, CMOS, Rambus™, GTL+, VME, LV-CMOS, LV-TTL, and PECL.

APPLICATIONS

- ◆ Mother Board
- ◆ PCI / AGP Graphics
- ◆ Game / Play Station
- ◆ Set Top Box
- ◆ IPC
- ◆ SCSI-III Bus terminator
- ◆ Buck Converter

FEATURES

- ◆ Patent Filed #6,452,366
- ◆ 16 pin PTSSOP and PSOP package
- ◆ Source and sink up to 3A, no heat sink required
- ◆ Peak Current to 6A
- ◆ Integrated Power MOSFETs
- ◆ Output voltage can be programmed by external resistors
- ◆ Separate voltages for VCCQ and PVDD
- ◆ V_{OUT} of $\pm 3\%$ or less at 3A
- ◆ Minimum external components
- ◆ Shutdown for standby or suspend mode operation
- ◆ Thermal shutdown protection
- ◆ Soft start

PIN CONFIGURATION

PSOP-16 (PS16)/PTSSOP-16 (PT16)
Top View

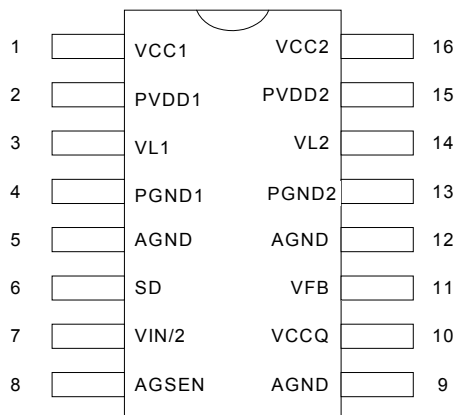

PIN DESCRIPTION

Pin No.	Symbol	Description	Operating Rating			
			Min.	Typ.	Max.	Unit
1,16	VCC1,VCC2	Voltage supply for internal circuits	2	2.5	4	V
2,15	PVDD1,PVDD2	Voltage supply for output power transistors	2	2.5	4	V
3,14	VL1,VL2	Output voltage/inductor connection (IDD1+IDD2, Output RMS current)	-3		3	A
4,13	PGND1,PGND2	Ground for output power transistors				
5,9,12	AGND	Ground for internal reference voltage divider				
8	AGSEN	Ground for remote sensing				
6	SD	Shutdown active high. CMOS input level	0.75 X VCC		VCC + 0.3V	V
7	VIN/2	Input for external reference voltage		VCCQ/2		V
10	VCCQ	Voltage reference for external voltage divider		2.5		V
11	VFB	Feedback node for the V _{TT}		VCCQ/2		V

BLOCK DIAGRAM

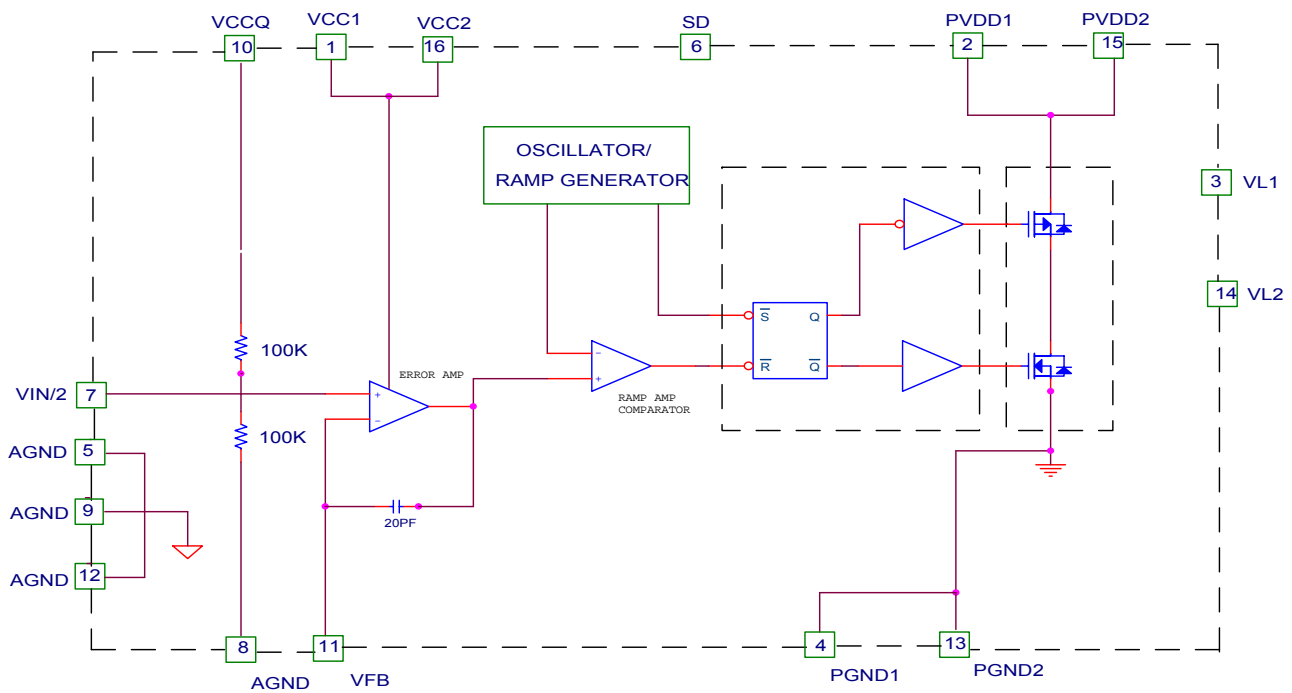

ORDERING INFORMATION

Part Number	Temperature Range	Package
CM8500IT	-40 to 85	16-Pin PTSSOP (PT16)
CM8500IS	-40 to 85	16-Pin PSOP (PS16)
CM8500GIT*	-40 to 85	16-Pin PTSSOP (PT16)
CM8500GIS*	-40 to 85	16-Pin PSOP (PS16)
CM8500TEVAL		Evaluation Board (T16)

*Note: G : Suffix for Pb Free Product

ABSOLUTE MAXIMUM RATINGS

Absolute maximum ratings are those values beyond which the device could be permanently damaged.

PVDD/VCC/VCCQ-0.3V to 4.0V
 Voltage on Any Other Pin GND – 0.3V to VCC + 0.3V
 Output RMS Current, Source or Sink3.0A

Junction Temperature150°C
 Storage Temperature -65°C to 125°C
 Lead Temperature (Soldering, 10 sec)..... 300°C
 Thermal Resistance (θ_{JA})..... 40°C/W

OPERATING CONDITIONS

Temperature Range -40°C to 85°C
 PVDD Operating Range2.0V to 4.0V

ELECTRICAL CHARACTERISTICS (Unless otherwise stated, these specifications apply $T_A=25^\circ\text{C}$; $V_{CC}=+3.3\text{V}$ and $PVDD=+3.3\text{V}$) maximum ratings are stress ratings only and functional device operation is not implied.

(Note 1)

Symbol	Parameter	Test Conditions	CM8500			Unit	
			Min.	Typ.	Max.		
SWITCHING REGULATOR							
VL	Output Voltage, SSTL_2	IOUT = 0, VIN/2 = open Note 2	VCCQ = 2.3V	1.12	1.15	1.18	V
			VCCQ = 2.5V	1.22	1.25	1.28	V
			VCCQ = 2.7V	1.32	1.35	1.38	V
		IOUT = ±3A, VIN/2 = open Note 3	VCCQ = 2.3V	1.09	1.15	1.21	V
			VCCQ = 2.5V	1.19	1.25	1.31	V
			VCCQ = 2.7V	1.28	1.35	1.42	V
VIN/2	Internal Resistor Divider	IOUT = 0 Note 2	VCCQ = 2.3V	1.139	1.15	1.162	V
			VCCQ = 2.5V	1.238	1.25	1.263	V
			VCCQ = 2.7V	1.337	1.35	1.364	V
ZIN	VIN/2 Reference Pin Input Impedance	Note 2	VCCQ = 0		50		K
fsw	Switching Frequency	CM8500		510	600	690	KHz
IOUT(RMS)	Maximum Output RMS Current	CM8500				3	A
IOUT(PEAK)	Maximum Output Peak Current	CM8500				6	A
MOSFETs							
RDS(ON)	Drain to Source on-State Resistance	PVDD=5V			150	180	m
SUPPLY							
IVCCA	Quiescent Current	VFB = 1.4V LC unconnected			200		µA
IPVDD		VFB = 1.4V LC unconnected			500		µA

Note 1: Limits are guaranteed by 100% testing, sampling, or correlation with worst case test conditions

Note 2: VCC, PVDD = 3.3V ±10%

Note 3: It's not 100% test

FUNCTIONAL DESCRIPTION

The CM8500 is a switching regulator that is capable of sinking and sourcing 3A of current without an external heat sink.

CM8500 uses a standard surface mount PTSSOP and PSOP package with bottom metal exposed and the heat can be piped through the bottom of the device and onto the PCB.

The CM8500 integrates power MOSFETs that are capable of source and sink 3A of current while maintaining excellent voltage regulation. The output voltage can be regulated within 3% or less by using the external feedback. Separate voltage supply inputs have been added to fit applications with various power supplies for the databus and power buses.

OUTPUTS

The output voltage pins (VL1, VL2) are tied to the databus, address, or clock lines via an external inductor. Output voltage is determined by the VCCQ or VIN/2 inputs.

INPUTS

The input voltage pins (VCCQ or VIN/2) determine the output voltages (VL1 or VL2). In the default mode, when the VIN/2 pin is open, the output voltage is 50% of the VCCQ input.

If a specific voltage is forced at the VIN/2 pin, the output voltage follows the voltage at the VIN/2 pin. VCCQ suggested connecting to VCCQ of memory module for better tracking with memory VCCQ.

OTHER SUPPLY VOLTAGES

Several inputs are provided for the supply voltages: PVDD1, PVDD2, VCC1, and VCC2.

The PVDD1 and PVDD2 provide the power supply to the power MOSFETs. VCC1 and VCC2 provide the voltage supply to the logic section and internal error amplifiers.

FEEDBACK

The VFB pin is an input that can be used for closed loop compensation. This input is derived from the voltage output. AGSEN pin is a contact node of internal resistor divider for remote sense.

APPLICATIONS

USING THE CM8500 FOR SSTL BUS TERMINATION

Figure 1 is the typical schematic of the CM8500TEVAL that shows the recommended approach for bus terminating solutions for SSTL-2 bus. This circuit can be used in PC memory and Graphics memory applications as shown in Figure 2 and Figure 3.

Figure 4 shows the PCB layout of the CM8500TEVAL.

Table 1 details the key parameters of SSTL_2 specification.

Figure 5 shows two different approach of SSTL_2 Terminated Output. (Refer to page 8 for detail description.)

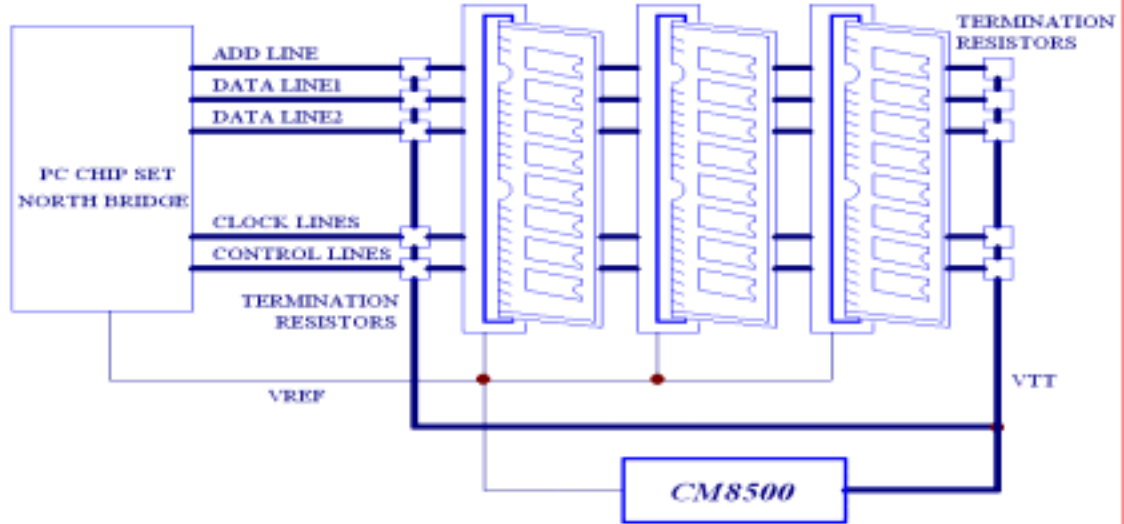

Figure 2. Termination Solution for PC Main Memory (Mother Boards)

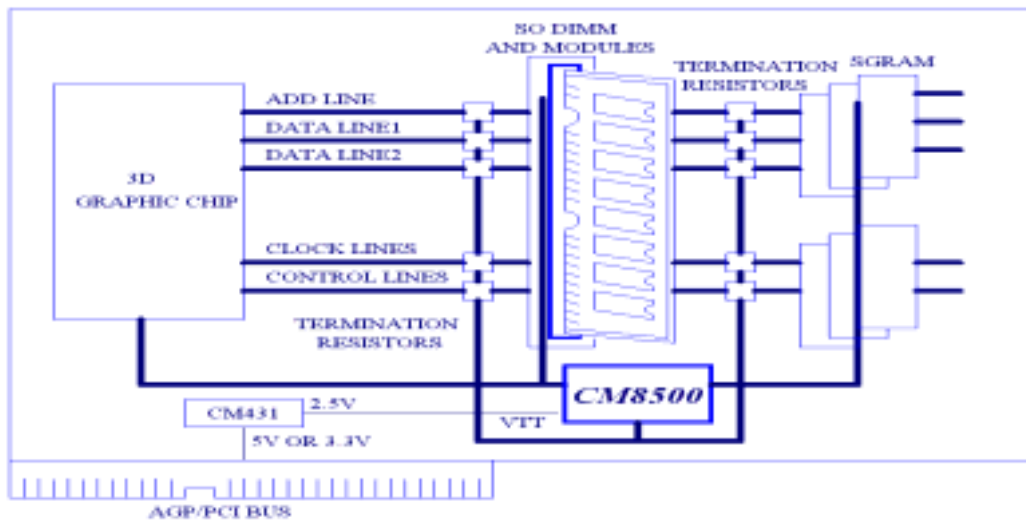

Figure 3. Termination Solution for Graphic Memory (AGP Graphics)

CM8500TEVAL PART LIST

Item	Q'ty	Description	Designator	Manufacturer
Resistors				
1	1	0805, 5 Ω , 1/8W	R1	
2	1	0805, 100 Ω , 1/8W	R8	
3	1	0805, 470 Ω , 1/8W	R9 (option)	
4	1	0805, 1K Ω , 1/8W	R4	
5	2	0805, 100K Ω , 1/8W	R3, R5	
Capacitors				
6	1	0805, 1nF/ 16V (102)	C6, C8	
7	6	0805, 0.1 μ F/ 16V (104)	C1, C2, C3, C4, C5	
8	1	0805, 1 μ F/ 16V (105)	C13	
9	1	CE 10, 820uF/ 6.3V	C7	Sanyo OSCON
10	2	B Size, Tant 10uF/ 6.3V	C10, C15	
11	4	D Size, Tant 100uF/ 6.3V	C9, C11, C12, C14	
Magnetics				
12	1	3.3uH 5A Inductor	L1	Bipolar Electronic Corp.
IC's				
13	1	CM8500IT	U1	Champion Microelectronic Corp.
14	1	CM431L	U2 (option)	Champion Microelectronic Corp.
Connectors				
15	1	2-pin, 2.54mm	J2	
16	4	2-pin Jumper, 2.54mm	J1, J3, J4, J6 (option)	
17	1	3-pin Jumper, 2.54mm	J5	
PCBs				
18	1	CM8500TEVAL PCB		Champion Microelectronic Corp.

Vendor Information

Bipolar Electronic Corp. Phn: +886-3-360 8892
Sanyo

CM8500TEVAL PCB LAYOUT

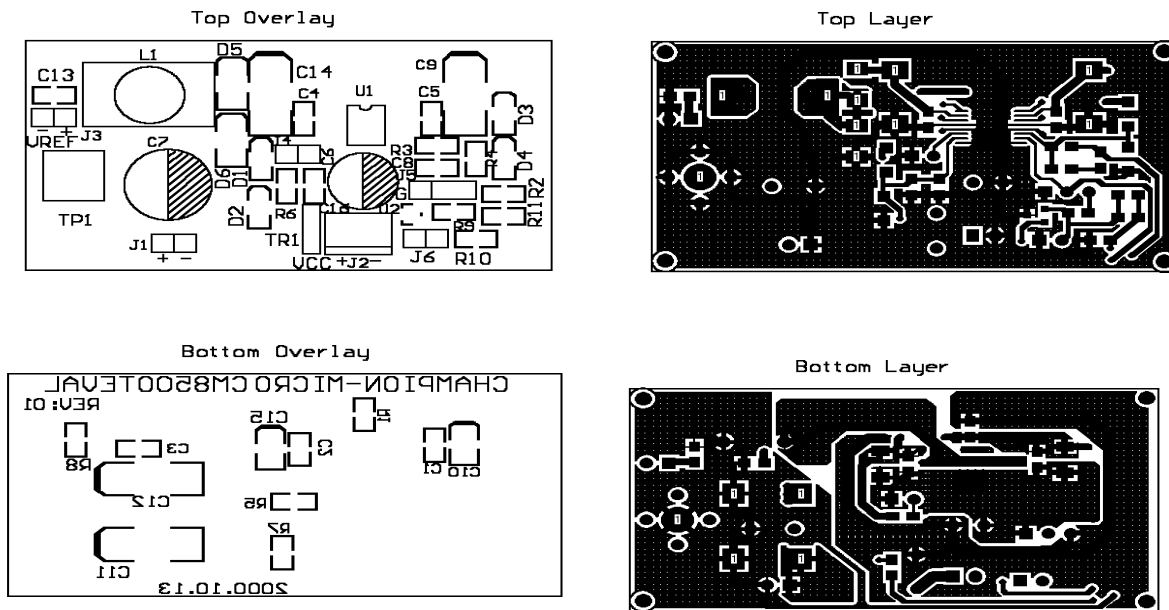

Figure 4. CM8500EVAL PCB Layout

SSTL-2 SPECIFICATIONS

SYMBOL	PARAMETER	MIN	TYP	MAX	UNITS
V_{DD}	Device Supply Voltage	V_{DDQ}		N/A	V
V_{DDQ}	Output Supply Voltage	2.3	2.5	2.7	V
V_{REF}	Input Reference Voltage	1.15	1.25	1.35	V
V_{TT}	Termination Voltage	$V_{REF} - 0.04$	V_{REF}	$V_{REF} + 0.04$	V
INPUT DC LOGIC LEVELS					
$V_{IH} (DC)$	DC Input Logic High	$V_{REF} + 0.18$		$V_{DDQ} + 0.3$	V
$V_{IL} (DC)$	DC Input Logic Low	- 0.3		$V_{REF} - 0.18$	V
INPUT AC LOGIC LEVELS					
$V_{IH} (AC)$	AC Input Logic High	$V_{REF} + 0.35$			V
$V_{IL} (AC)$	AC Input Logic Low			$V_{REF} - 0.35$	V
OUTPUT DC CURRENT DRIVE					
$I_{OH} (DC)$	Output Minimum Source DC Current	- 15.2			mA
$I_{OL} (DC)$	Output Minimum Sink DC Current	15.2			mA

Notes: V_{REF} and V_{TT} must track variations in V_{DDQ}
 Peak-to-peak AC noise on V_{REF} may not exceed $\pm 2\% V_{REF} (DC)$
 V_{TT} of transmitting device must track V_{REF} of receiving device

Table 1. Key Specifications for SSTL_2

SSTL_2 TERMINATED OUTPUT

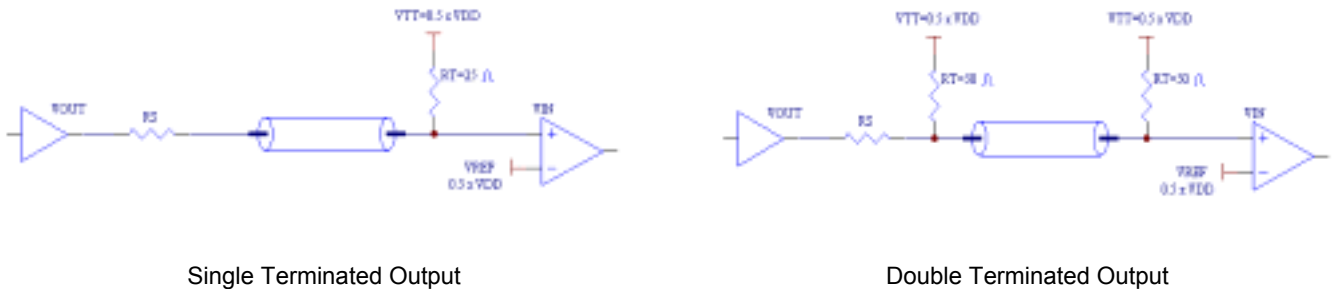

Figure 5. SSTL_2 Terminated Output

Note.

The SSTL_2 specification requires adequate output current drive so that parallel termination schemes can be used. The use of parallel termination is important for high-speed signaling, since it allows proper termination of the bus transmission lines, which reduces signal reflections. The result will be improved settling, lower EMI emissions, and higher possible clock rates. A minimum termination resistance of 23Ω to V_{TT} can be used and still comply with the minimum output voltages and output currents of the SSTL_2 specification.

Two choices for implementing the parallel termination are shown in Figure 5.

Double Terminated Output

The bus is terminated at both ends with a 50Ω resistor, for a combined parallel resistance of 25Ω .

Single Terminated Output

The bus is terminated at the far end from the controller with a single 25Ω resistor.

It is strongly recommended that the single resistor termination scheme be used for best performance. The benefits of this approach include reduced cost, simpler signal routing, reduced reflections, and better signal bandwidth and settling.

CM8500EVAL TESTING DIAGRAM

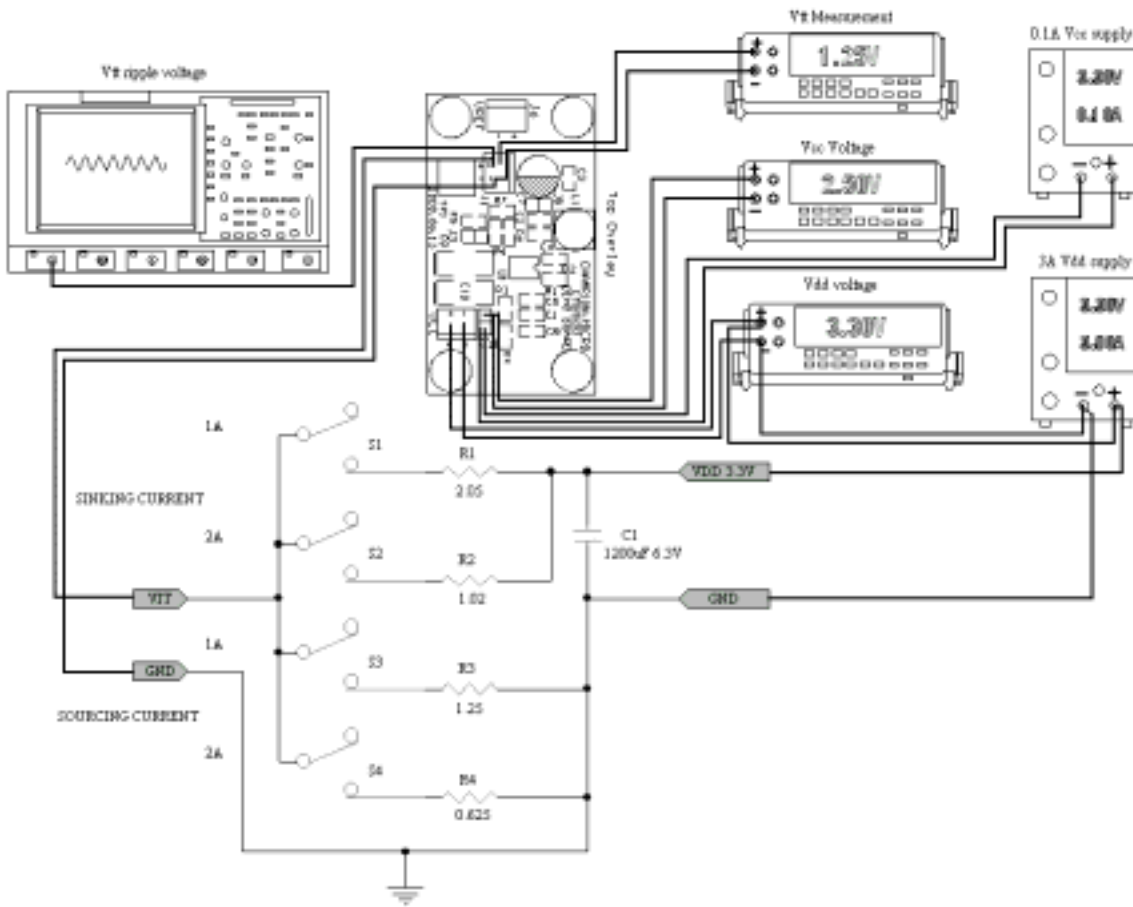
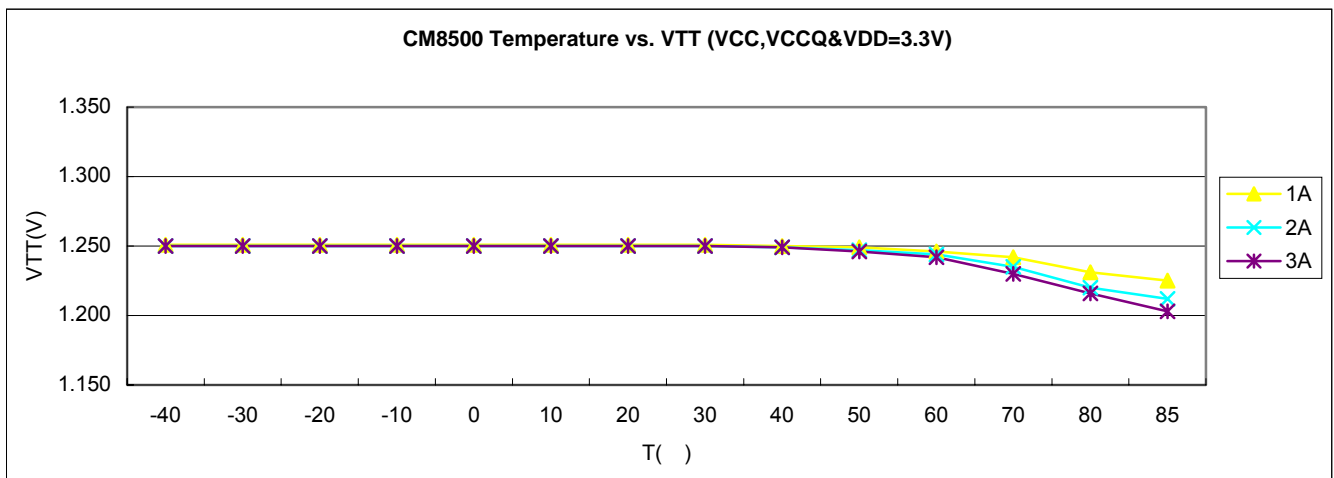
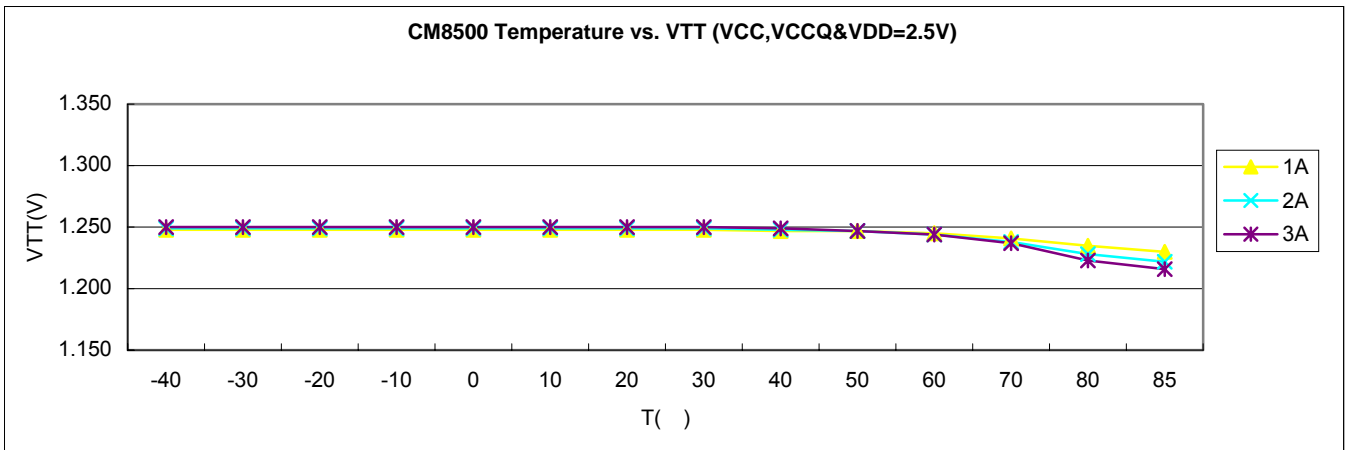

Figure 6. CM8500EVAL Typical Testing Diagram

TYPICAL CHARACTERISTICS



Temperature vs. VTT VCC, VCCQ & VDD=3.3V



Temperature vs. VTT VCC, VCCQ & VDD=2.5V

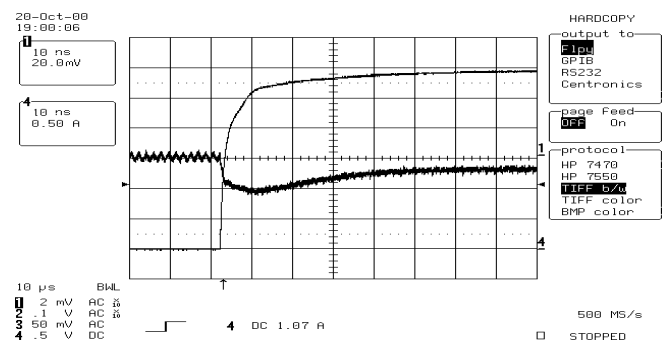

2V INPUT LOAD: 0A - 3A

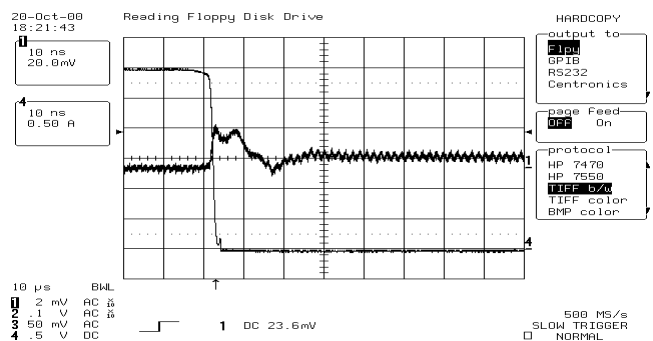

2V INPUT LOAD: 3A - 0A

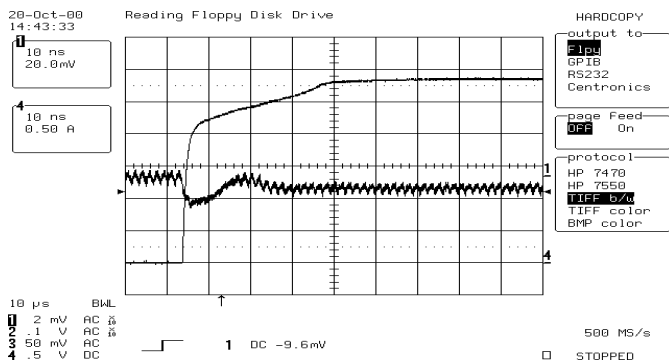

2.5V INPUT LOAD: 0A - 3A

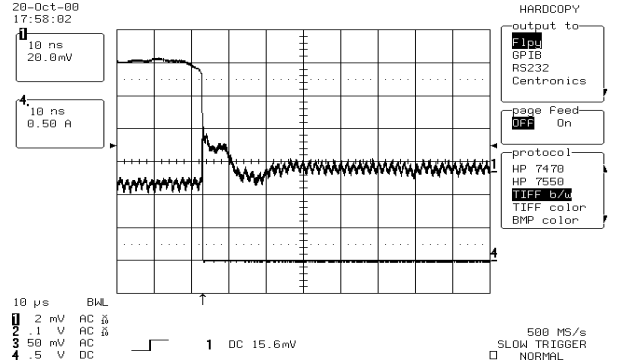

2.5V INPUT LOAD: 3A - 0A

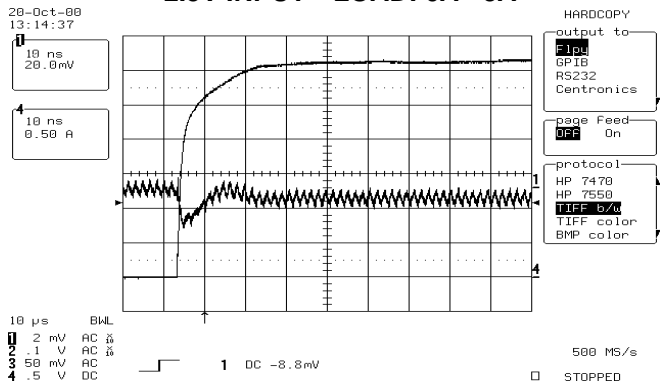

3.3V INPUT LOAD: 0A - 3A

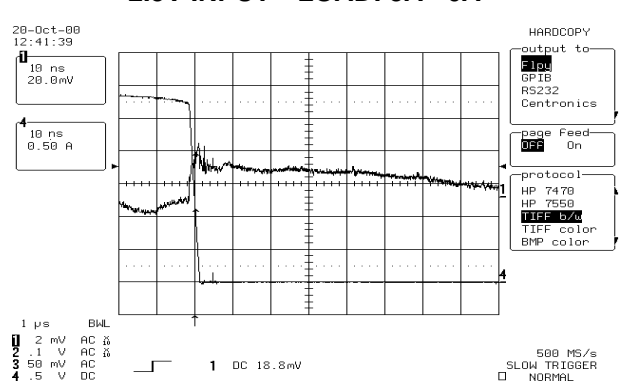

3.3V INPUT LOAD: 3A - 0A

PACKAGE DIMENSION

16-PIN PTSSOP (PT16)

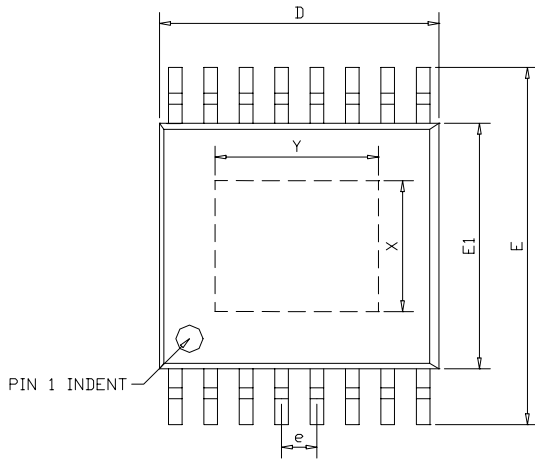

SYMBOLS	DIMENSIONS IN MILLIMETERS			DIMENSIONS IN INCHS		
	MIN	NOM	MAX	MIN	NOM	MAX
A1	0.05	---	0.15	0.002	---	0.006
A2	0.84	---	0.94	0.033	---	0.037
b	0.20	---	0.30	0.008	---	0.012
c	0.10	---	0.20	0.004	---	0.008
D	4.88	---	5.13	0.192	---	0.202
E	6.25	---	6.55	0.246	---	0.258
E1	4.29	---	4.50	0.169	---	0.177
e	---	0.65	---	---	0.026	---
L	0.51	---	0.71	0.020	---	0.028
θ	0°	---	8°	0°	---	8°

EXPOSED PAD DIMENSION : (mm)
PAD SIZE: X=2.4; Y=3.0

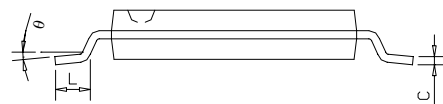
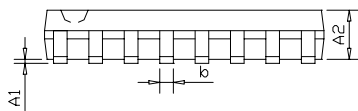

16-PIN PSOP (PS16)

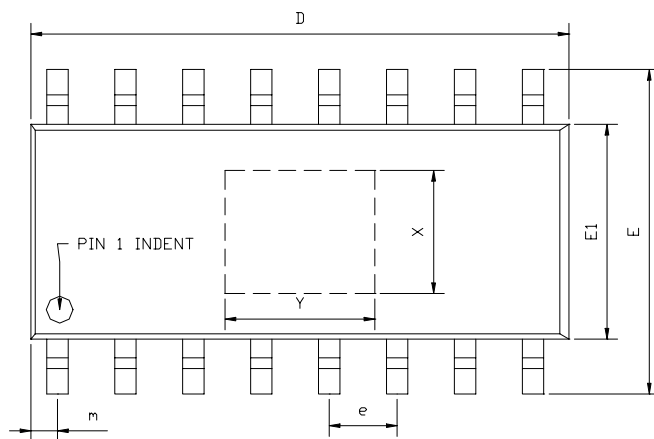

SYMBOLS	DIMENSIONS IN MILLIMETERS			DIMENSIONS IN INCHS		
	MIN	NOM	MAX	MIN	NOM	MAX
A1	0.05	---	0.15	0.002	---	0.006
A2	1.40	---	1.55	0.055	---	0.061
b	0.30	---	0.51	0.012	---	0.020
C	0.15	---	0.26	0.006	---	0.010
D	9.80	---	10.06	0.386	---	0.396
E	5.79	---	6.20	0.228	---	0.244
E1	3.76	---	4.01	0.148	---	0.158
e	---	1.27	---	---	0.050	---
L	0.38	---	0.69	0.015	---	0.035
m	0.43	---	0.69	0.017	---	0.027
θ	0°	---	8°	0°	---	8°

EXPOSED PAD DIMENSION : (mm)
PAD SIZE: X=2.3 ; Y=2.8

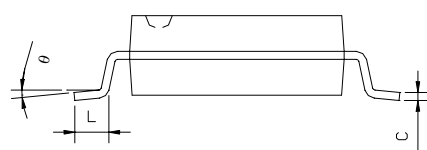
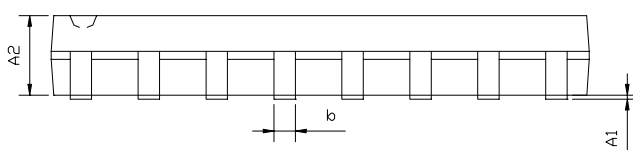

IMPORTANT NOTICE

Champion Microelectronic Corporation (CMC) reserves the right to make changes to its products or to discontinue any integrated circuit product or service without notice, and advises its customers to obtain the latest version of relevant information to verify, before placing orders, that the information being relied on is current.

A few applications using integrated circuit products may involve potential risks of death, personal injury, or severe property or environmental damage. CMC integrated circuit products are not designed, intended, authorized, or warranted to be suitable for use in life-support applications, devices or systems or other critical applications. Use of CMC products in such applications is understood to be fully at the risk of the customer. In order to minimize risks associated with the customer's applications, the customer should provide adequate design and operating safeguards.

HsinChu Headquarter

5F, No. 11, Park Avenue II,
Science-Based Industrial Park,
HsinChu City, Taiwan 300

TEL: +886-3-567 9979

FAX: +886-3-567 9909

<http://www.champion-micro.com>

Sales & Marketing

11F, No. 306-3, Sec. 1, Ta Tung Rd.,
Hsichih, Taipei Hsien
Taiwan 221

TEL: +886-2-8692 1591

FAX: +886-2-8692 1596