



虹冠電子工業股份有限公司
Champion Microelectronic Corporation

Specialized in Integrated High Efficient Switching Power Management Solutions
高整合高效率交換型電源管理方案之專業 I C 設計



上海台永商貿有限公司

SHANGHAI TAIYONG CO.,LTD

上海市普陀區桐柏路 165 弄 1 號 101-103 室

(上海)TEL:86-21-59512136

(上海)FAX:86-21-59512123

E-mail: shanghai@shanghai-taiyong.com

E-mail: shanghai@ynv-gsm.com

東莞辦事處

SHANGHAI TAIYONG CO.,LTD

東省東莞市長安鎮烏沙江貝村同和四巷 15 號

(東莞) TEL:86-769-5373287

(東莞) FAX:86-769-5373286

E-mail: dong-guan@shanghai-taiyong.com

E-mail: dong-guan@ynv-gsm.com

GENERAL DESCRIPTION

The CM2830/CM2830A family is a positive voltage linear regulator developed utilizing CMOS technology featured low quiescent current (30µA typ.), low dropout voltage, and high output voltage accuracy. Built-in low on-resistance transistor provides low dropout voltage and large output current. A 2.2µF or greater can be used as an output capacitor.

The SOT-23-3, SOT-23-5, and TO-92 miniaturized package and the SOT-89 package are recommended for configuring portable devices and large current application, respectively.

These robust devices are designed to prevent device failure under the worst operation condition with both Thermal Shutdown and Current Fold-back.

FEATURES

- ◆ Very Low Dropout Voltage
- ◆ Low Current Consumption: Typ. 30µA, Max. 35µA
- ◆ Output Voltage: 1.5V, 1.8V, 1.9V, 2.0V, 2.2V, 2.5V, 2.7V, 2.8V, 2.9V, 3.0V, 3.3V, 3.5V, 3.6V, and 3.8V
- ◆ High Accuracy Output Voltage: +/- 1.5%
- ◆ Guaranteed 300mA Output
- ◆ Input Range of 2.8V to 7.0V
- ◆ Thermal Shutdown
- ◆ Current Limiting
- ◆ Compact Package: TO-92, SOT-23-3, SOT-23-5, and SOT-89
- ◆ Factory Pre-set Output Voltages
- ◆ Short Circuit Current Fold-Back
- ◆ Low Temperature Coefficient

APPLICATIONS

- ◆ Battery-powered devices
- ◆ Personal communication devices
- ◆ Home electric/electronic appliances
- ◆ PC peripherals

24 Hours Technical Support--WebSIM

Champion provides customers an online circuit simulation tool called WebSIM. You could simply logon our website at www.champion-micro.com for details.

TYPICAL APPLICATIONS

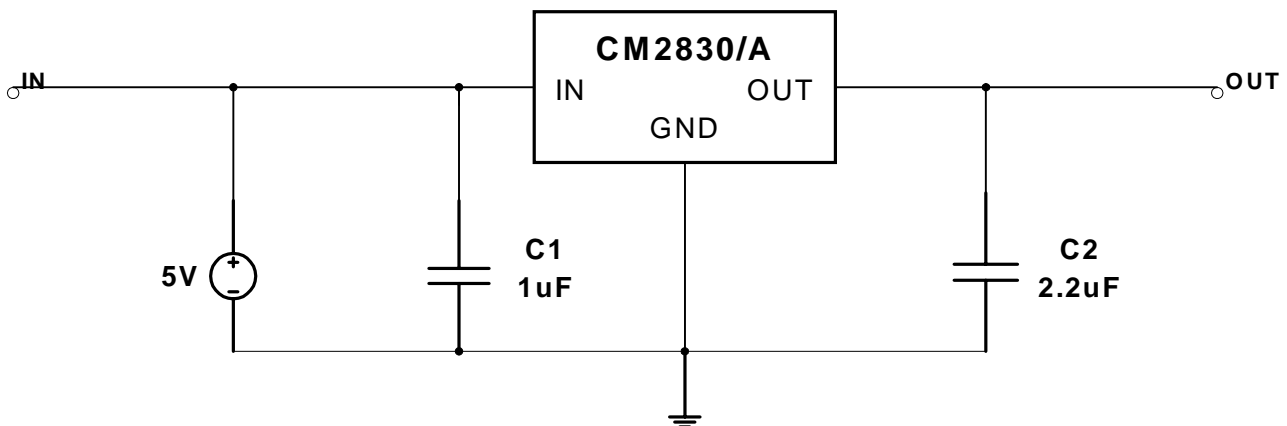

PIN CONFIGURATION

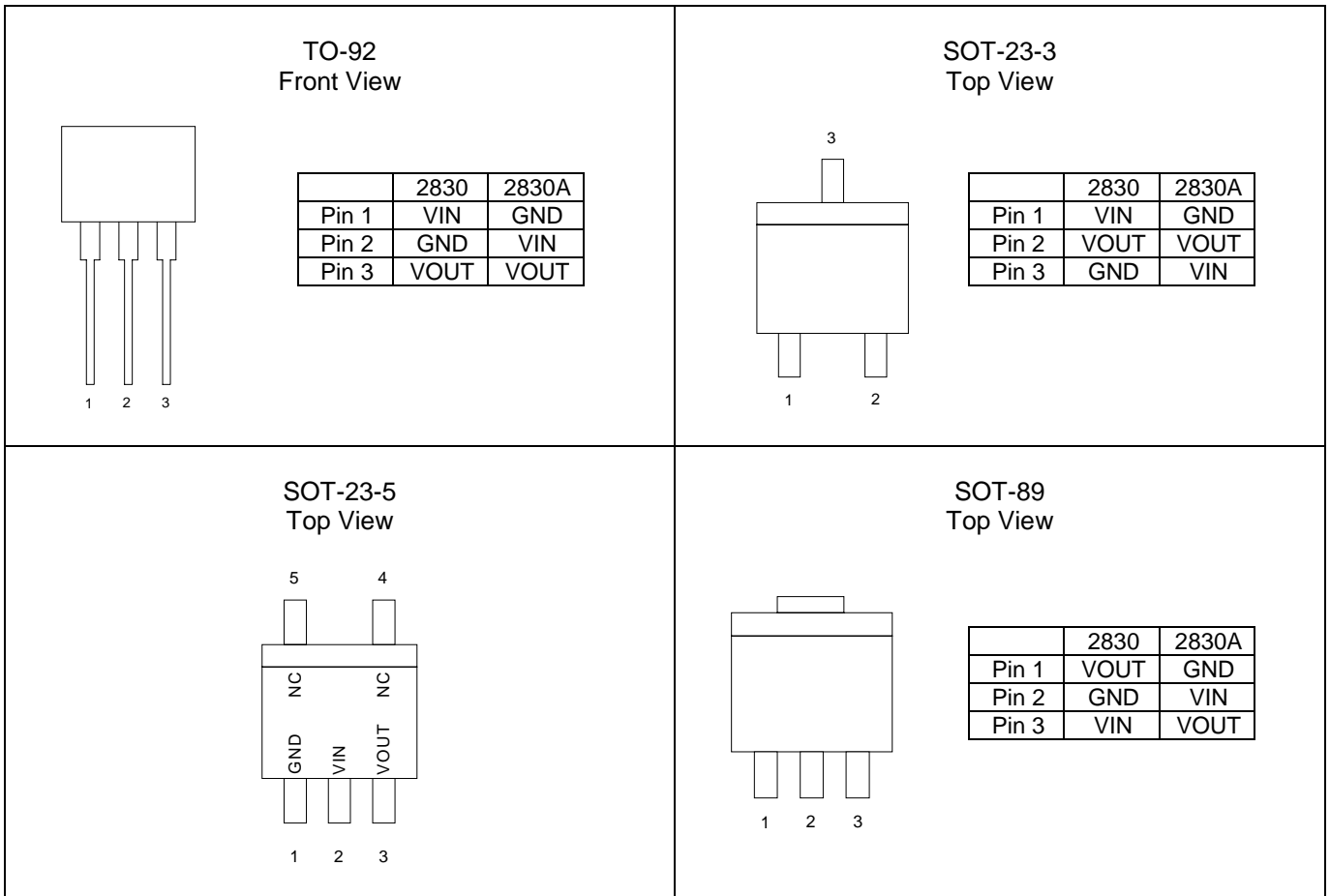

BLOCK DIAGRAM

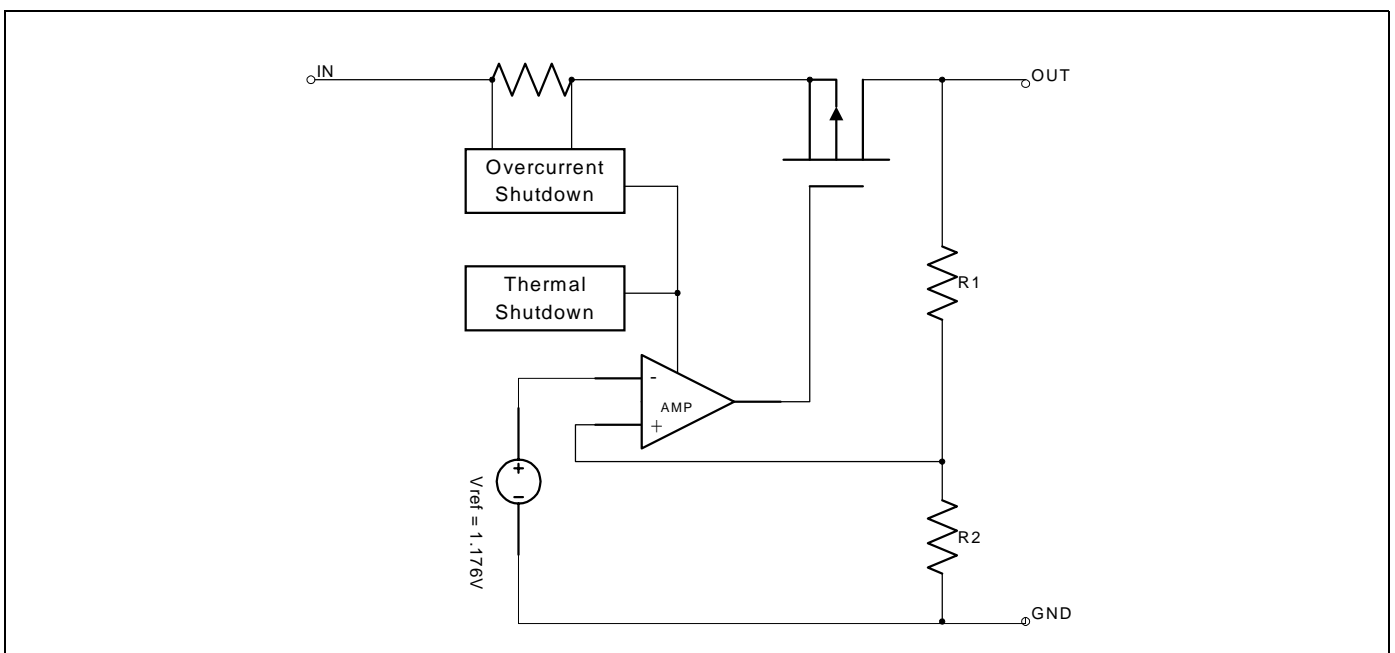

ORDERING INFORMATION**CM2830**

Part Number	Output Voltage	Temperature Range	Package
CM2830AIN92	1.5V	-40°C ~ +85°C	TO-92
CM2830AIM23	1.5V	-40°C ~ +85°C	SOT-23-3
CM2830AIM25	1.5V	-40°C ~ +85°C	SOT-23-5
CM2830AIM89	1.5V	-40°C ~ +85°C	SOT-89
CM2830DIN92	1.8V	-40°C ~ +85°C	TO-92
CM2830DIM23	1.8V	-40°C ~ +85°C	SOT-23-3
CM2830DIM25	1.8V	-40°C ~ +85°C	SOT-23-5
CM2830DIM89	1.8V	-40°C ~ +85°C	SOT-89
CM2830EIN92	1.9V	-40°C ~ +85°C	TO-92
CM2830EIM23	1.9V	-40°C ~ +85°C	SOT-23-3
CM2830EIM25	1.9V	-40°C ~ +85°C	SOT-23-5
CM2830EIM89	1.9V	-40°C ~ +85°C	SOT-89
CM2830FIN92	2.0V	-40°C ~ +85°C	TO-92
CM2830FIM23	2.0V	-40°C ~ +85°C	SOT-23-3
CM2830FIM25	2.0V	-40°C ~ +85°C	SOT-23-5
CM2830FIM89	2.0V	-40°C ~ +85°C	SOT-89
CM2830HIN92	2.2V	-40°C ~ +85°C	TO-92
CM2830HIM23	2.2V	-40°C ~ +85°C	SOT-23-3
CM2830HIM25	2.2V	-40°C ~ +85°C	SOT-23-5
CM2830HIM89	2.2V	-40°C ~ +85°C	SOT-89
CM2830KIN92	2.5V	-40°C ~ +85°C	TO-92
CM2830KIM23	2.5V	-40°C ~ +85°C	SOT-23-3
CM2830KIM25	2.5V	-40°C ~ +85°C	SOT-23-5
CM2830KIM89	2.5V	-40°C ~ +85°C	SOT-89
CM2830MIN92	2.7V	-40°C ~ +85°C	TO-92
CM2830MIM23	2.7V	-40°C ~ +85°C	SOT-23-3
CM2830MIM25	2.7V	-40°C ~ +85°C	SOT-23-5
CM2830MIM89	2.7V	-40°C ~ +85°C	SOT-89
CM2830NIN92	2.8V	-40°C ~ +85°C	TO-92
CM2830NIM23	2.8V	-40°C ~ +85°C	SOT-23-3
CM2830NIM25	2.8V	-40°C ~ +85°C	SOT-23-5
CM2830NIM89	2.8V	-40°C ~ +85°C	SOT-89
CM2830OIN92	2.9V	-40°C ~ +85°C	TO-92
CM2830OIM23	2.9V	-40°C ~ +85°C	SOT-23-3
CM2830OIM25	2.9V	-40°C ~ +85°C	SOT-23-5
CM2830OIM89	2.9V	-40°C ~ +85°C	SOT-89
CM2830PIN92	3.0V	-40°C ~ +85°C	TO-92
CM2830PIM23	3.0V	-40°C ~ +85°C	SOT-23-3
CM2830PIM25	3.0V	-40°C ~ +85°C	SOT-23-5
CM2830PIM89	3.0V	-40°C ~ +85°C	SOT-89

ORDERING INFORMATION (CONTINUED)

Part Number	Output Voltage	Temperature Range	Package
CM2830SIN92	3.3V	-40°C ~ +85°C	TO-92
CM2830SIM23	3.3V	-40°C ~ +85°C	SOT-23-3
CM2830SIM25	3.3V	-40°C ~ +85°C	SOT-23-5
CM2830SIM89	3.3V	-40°C ~ +85°C	SOT-89
CM2830UIN92	3.5V	-40°C ~ +85°C	TO-92
CM2830UIM23	3.5V	-40°C ~ +85°C	SOT-23-3
CM2830UIM25	3.5V	-40°C ~ +85°C	SOT-23-5
CM2830UIM89	3.5V	-40°C ~ +85°C	SOT-89
CM2830VIN92	3.6V	-40°C ~ +85°C	TO-92
CM2830VIM23	3.6V	-40°C ~ +85°C	SOT-23-3
CM2830VIM25	3.6V	-40°C ~ +85°C	SOT-23-5
CM2830VIM89	3.6V	-40°C ~ +85°C	SOT-89
CM2830XIN92	3.8V	-40°C ~ +85°C	TO-92
CM2830XIM23	3.8V	-40°C ~ +85°C	SOT-23-3
CM2830XIM25	3.8V	-40°C ~ +85°C	SOT-23-5
CM2830XIM89	3.8V	-40°C ~ +85°C	SOT-89

Note: For other pre-set output voltage, please contact Champion Sales office.

CM2830A

Part Number	Output Voltage	Temperature Range	Package
CM2830AAIN92	1.5V	-40°C ~ +85°C	TO-92
CM2830AAIM23	1.5V	-40°C ~ +85°C	SOT-23-3
CM2830AAIM89	1.5V	-40°C ~ +85°C	SOT-89
CM2830ADIN92	1.8V	-40°C ~ +85°C	TO-92
CM2830ADIM23	1.8V	-40°C ~ +85°C	SOT-23-3
CM2830ADIM89	1.8V	-40°C ~ +85°C	SOT-89
CM2830AEIN92	1.9V	-40°C ~ +85°C	TO-92
CM2830AEIM23	1.9V	-40°C ~ +85°C	SOT-23-3
CM2830AEIM89	1.9V	-40°C ~ +85°C	SOT-89
CM2830AFIN92	2.0V	-40°C ~ +85°C	TO-92
CM2830AFIM23	2.0V	-40°C ~ +85°C	SOT-23-3
CM2830AFIM89	2.0V	-40°C ~ +85°C	SOT-89
CM2830AHIN92	2.2V	-40°C ~ +85°C	TO-92
CM2830AHIM23	2.2V	-40°C ~ +85°C	SOT-23-3
CM2830AHIM89	2.2V	-40°C ~ +85°C	SOT-89
CM2830AKIN92	2.5V	-40°C ~ +85°C	TO-92
CM2830AKIM23	2.5V	-40°C ~ +85°C	SOT-23-3
CM2830AKIM89	2.5V	-40°C ~ +85°C	SOT-89
CM2830AMIN92	2.7V	-40°C ~ +85°C	TO-92
CM2830AMIM23	2.7V	-40°C ~ +85°C	SOT-23-3
CM2830AMIM89	2.7V	-40°C ~ +85°C	SOT-89

ORDERING INFORMATION (CONTINUED)

Part Number	Output Voltage	Temperature Range	Package
CM2830ANIN92	2.8V	-40°C ~ +85°C	TO-92
CM2830ANIM23	2.8V	-40°C ~ +85°C	SOT-23-3
CM2830ANIM89	2.8V	-40°C ~ +85°C	SOT-89
CM2830AOIN92	2.9V	-40°C ~ +85°C	TO-92
CM2830AOIM23	2.9V	-40°C ~ +85°C	SOT-23-3
CM2830AOIM89	2.9V	-40°C ~ +85°C	SOT-89
CM2830APIN92	3.0V	-40°C ~ +85°C	TO-92
CM2830APIM23	3.0V	-40°C ~ +85°C	SOT-23-3
CM2830APIM89	3.0V	-40°C ~ +85°C	SOT-89
CM2830ASIN92	3.3V	-40°C ~ +85°C	TO-92
CM2830ASIM23	3.3V	-40°C ~ +85°C	SOT-23-3
CM2830ASIM89	3.3V	-40°C ~ +85°C	SOT-89
CM2830AUIN92	3.5V	-40°C ~ +85°C	TO-92
CM2830AUIM23	3.5V	-40°C ~ +85°C	SOT-23-3
CM2830AUIM89	3.5V	-40°C ~ +85°C	SOT-89
CM2830AVIN92	3.6V	-40°C ~ +85°C	TO-92
CM2830AVIM23	3.6V	-40°C ~ +85°C	SOT-23-3
CM2830AVIM89	3.6V	-40°C ~ +85°C	SOT-89
CM2830AXIN92	3.8V	-40°C ~ +85°C	TO-92
CM2830AXIM23	3.8V	-40°C ~ +85°C	SOT-23-3
CM2830AXIM89	3.8V	-40°C ~ +85°C	SOT-89

Note: For other pre-set output voltage, please contact Champion Sales office.



ABSOLUTE MAXIMUM RATINGS

Input Voltage +7V
 Output Current $P_D / (V_{IN} - V_o)$
 Output Voltage GND-0.3V to $V_{IN}+0.3V$
 ESD Classification B

OPERATING RATINGS

Ambient Temperature Range (T_A) -40°C to +85°C
 Junction Temperature Range -40°C to +125°C

THERMAL INFORMATION

Parameter		Maximum	Unit
Thermal Resistance (θ_{jc})	SOT-23-3	110	°C/W
	SOT-23-5	81	
	SOT-89	18	
	TO-92	80	
Thermal Resistance (θ_{ja})	SOT-23-3	325	°C/W
	SOT-23-5	260	
	SOT-89	180	
	TO-92	160	
Internal Power Dissipation (P_D) ($\Delta T = 100^\circ C$)	SOT-23-3	300	mW
	SOT-23-5	380	
	SOT-89	550	
	SOT-89	2750*	
	TO-92	625	
Maximum Junction Temperature		150	°C
Maximum Lead Temperature (10 Sec)		300	°C

*With Junction sink capable of twice times of θ_{jc}

Caution: Stress above the listed absolute rating may cause permanent damage to the device.

ELECTRICAL CHARACTERISTICS

T_A = +25°C; unless otherwise noted

Parameter	Test Conditions	CM2830/CM2830A			Unit
		Min.	Typ.	Max.	
Input Voltage		Note 1		7	V
Output Voltage Accuracy	I _o = 1mA to 300mA	-1.5		1.5	%
Dropout Voltage	I _o =300mA, V _{OUT} =V _{OUT} -2.0%, V _{OUT} >2.5V		300		mV
	I _o =300mA, V _{OUT} =V _{OUT} -2.0%, V _{OUT} <=2.5V		800		mV
Output Current	V _{OUT} > 1.2V	300			mA
Short Circuit Current	V _{OUT} < 1.05V		150	300	mA
Current Limit	V _{OUT} >1.2V	300	450		mA
Quiescent Current	V _{IN} =5V, No Load		30	35	μA
Ground Pin Current	I = 1mA to 300mA		30	35	μA
Line Regulation	I _{OUT} =5mA, V _{IN} =V _{OUT} +1 to V _{OUT} +2, V _{OUT} <= 3.0V	-0.15	0.03	0.15	%
	I _{OUT} =5mA, V _{IN} =V _{OUT} +1 to V _{OUT} +2, V _{OUT} > 3.0V	-0.3	0.06	0.3	
Load Regulation	I _o =1mA to 300mA		0.2	1	%
Power Supply Rejection	I _o = 100mA C _o =2.2μF ceramic	f=1KHz		60	dB
		f=10KHz		50	
		f=100KHz		40	
Over Temperature Shutdown			150		°C
Over Temperature Hysteresis			30		°C
Output Noise	F=10Hz to 100kHz, C _o =2.2μF, I _o = 10mA		30		μVrms
Output Voltage Temp. Coeff.			25		ppm/°C

Note 1. V_{IN(MIN)} = V_{OUT} + 0.3V

DETAILED DESCRIPTION

The CM2830/CM2830A family of CMOS regulators contain a PMOS pass transistor, voltage reference, error amplifier, over-current protection, thermal shutdown, and short circuit protection.

The P-channel pass transistor receives data from the error amplifier, over-current shutdown, short output protection, and thermal protection circuits. During normal operation, the error amplifier compares the output voltage to a precision reference. Over-current and Thermal shutdown circuits become active when the junction temperature exceeds 150°C, or the current exceeds 300mA. During thermal shutdown, the output voltage remains low. Normal operation is restored when the junction temperature drops below 120°C.

The CM2830/CM2830A switches from voltage mode to current mode when the load exceeds the rated output current. This prevents over-stress. The CM2830 also incorporates current fold-back to reduce power dissipation when the output is short-circuited. This feature becomes active when the output drops below 1.05V, and reduces the current flow by 65%. Full current is restored when the voltage exceeds 1.05V.

EXTERNAL CAPACITOR

The CM2830/2830A is stable with an output capacitor to ground of 2.2μF or greater. It can keep stable even with higher or poor ESR capacitors. A second capacitor is recommended between the input and ground to stabilize V_{IN}. The input capacitor should be larger than 0.1μF to have a beneficial effect. All capacitors should be placed in close proximity to the pins. A “quiet” ground termination is desirable.

TYPICAL ELECTRICAL CHARACTERISTICS

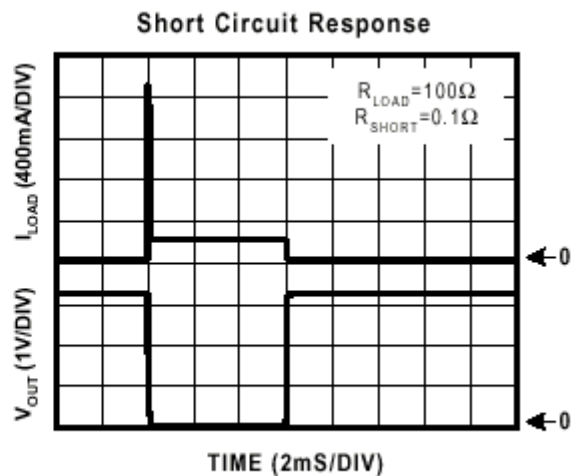
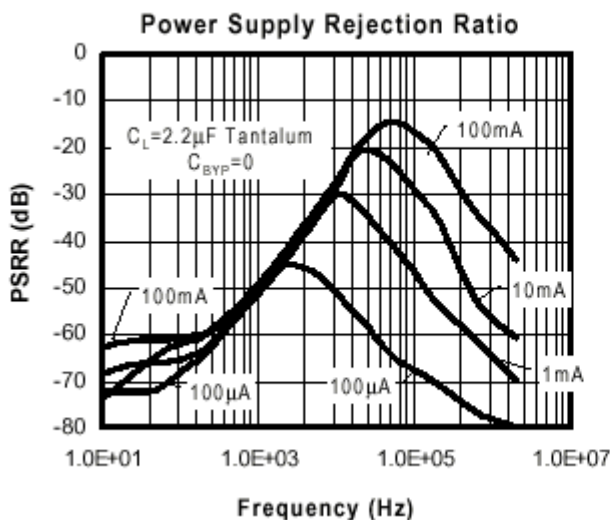
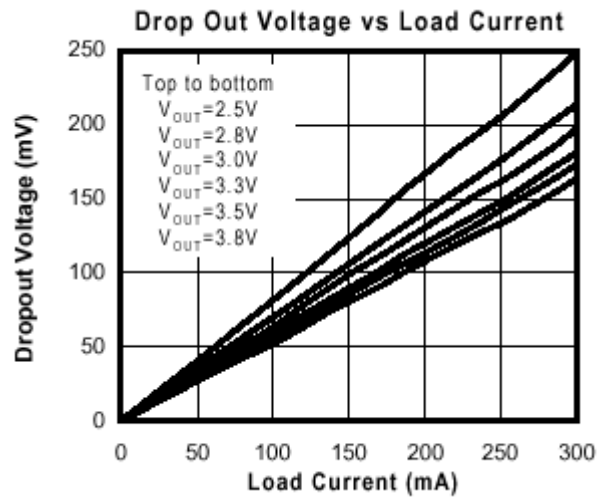
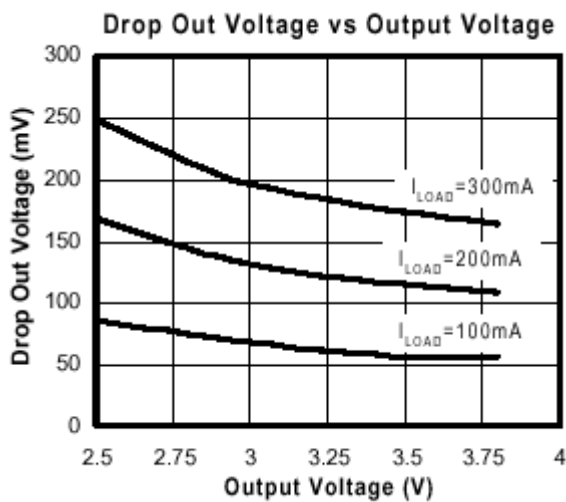
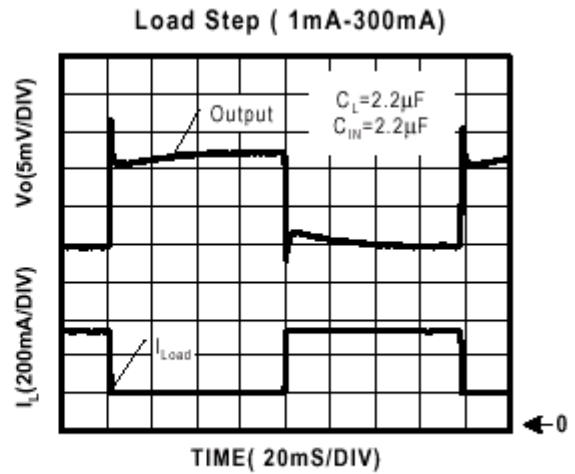
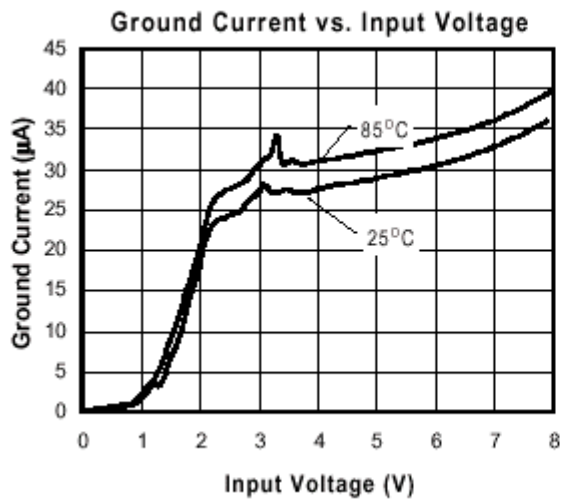

Overtemperature Shutdown

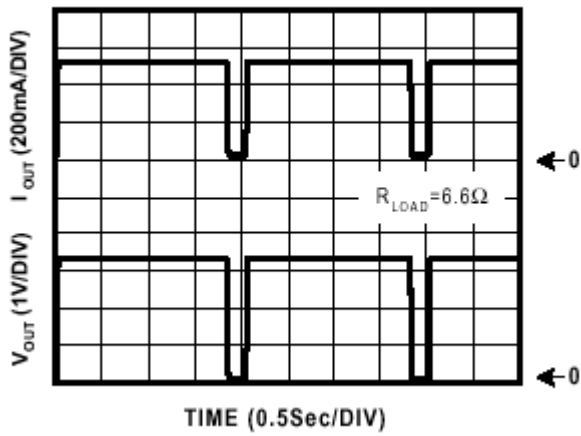

Current Limit Response

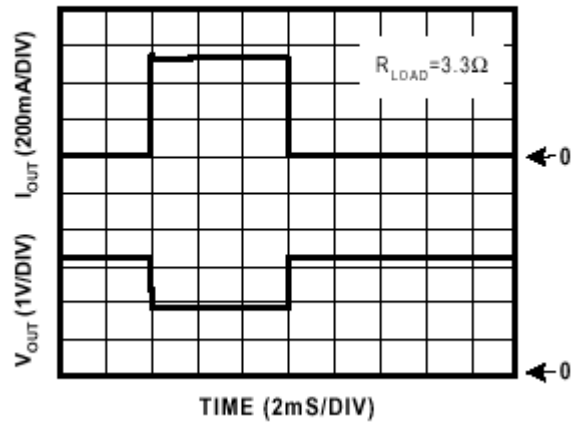

Noise Measurement

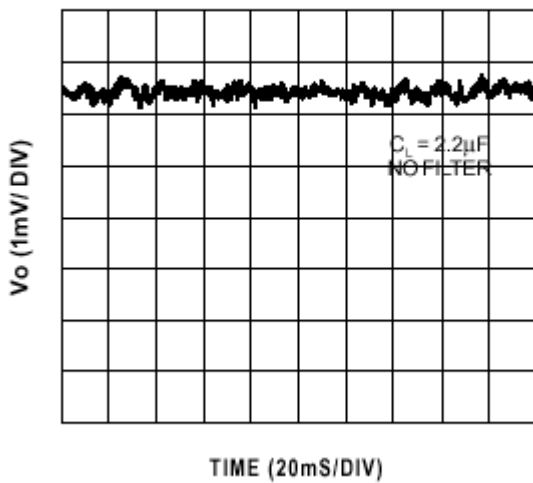

Transient Line Response

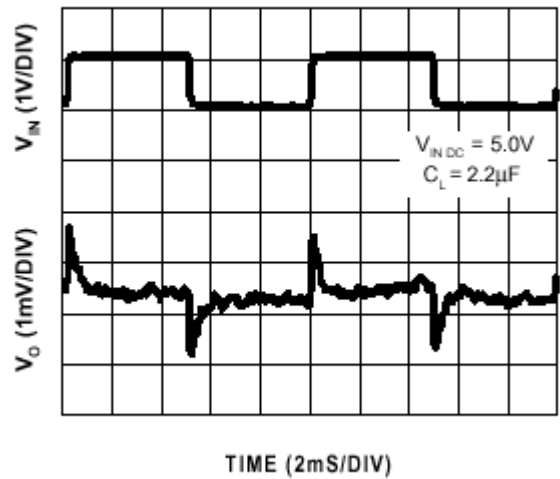

Safe Operating Area

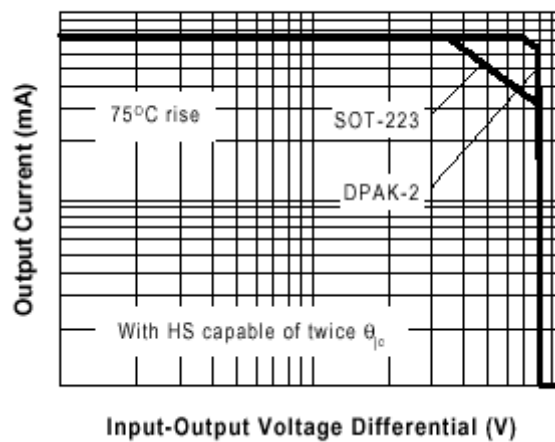

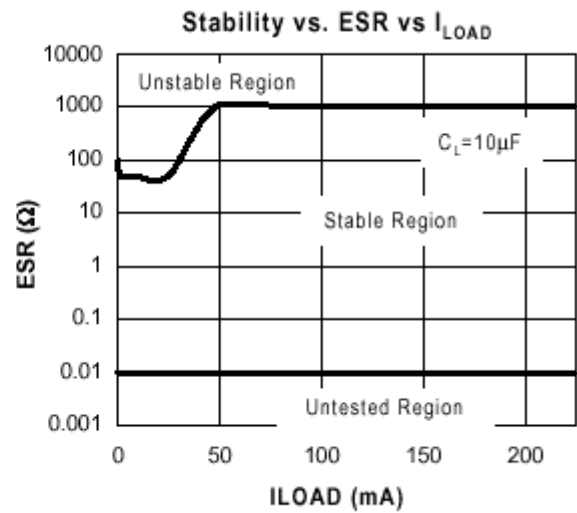
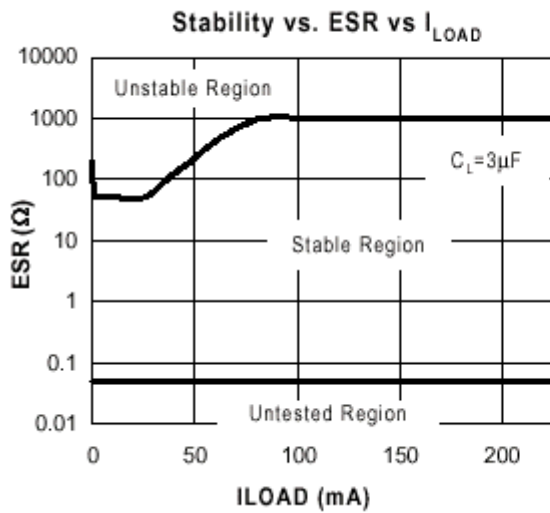
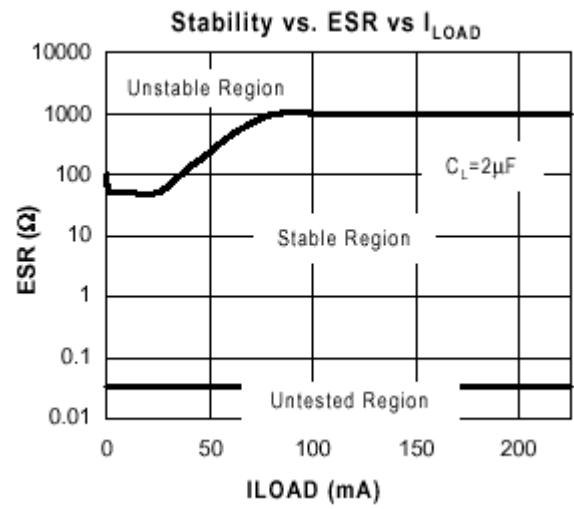
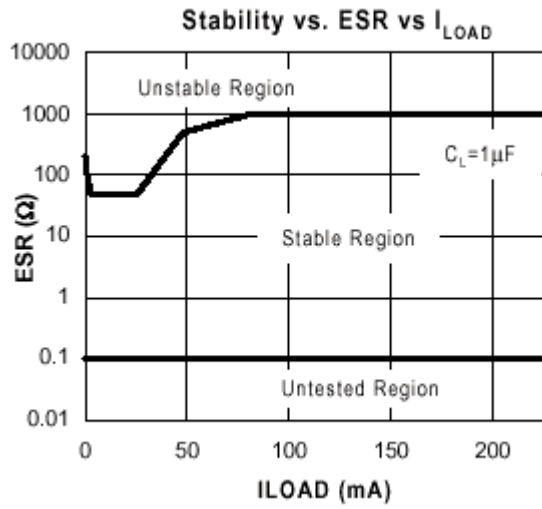

PACKAGE DIMENSION

TO-92 (N92)



SYMBOLS	DIMENSIONS IN MILLIMETERS			DIMENSIONS IN INCHES		
	MIN	NOM	MAX	MIN	NOM	MAX
A	3.45	3.56	3.66	0.136	0.140	0.144
A1	1.22	1.30	1.37	0.048	0.051	0.054
b	---	0.38	---	---	0.015	---
D	4.27	4.52	4.78	0.168	0.178	0.188
D1	4.14	4.29	4.45	0.163	0.169	0.175
E	4.32	4.57	4.83	0.170	0.180	0.190
L	12.98	13.49	14.00	0.511	0.531	0.551
e	---	1.27	---	---	0.050	---
theta	---	5°	---	---	5°	---
theta1	---	5°	---	---	5°	---

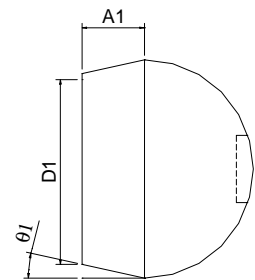
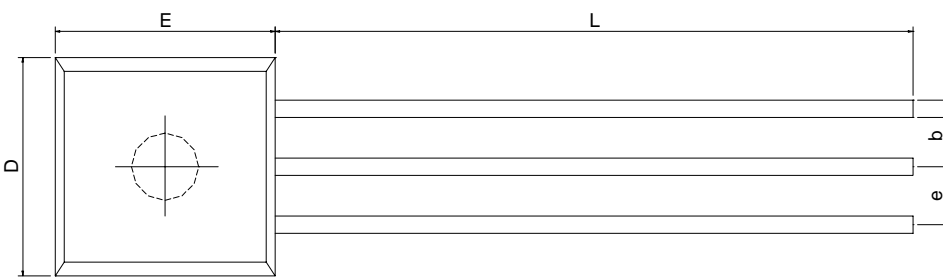

SOT-23-3 (M23)

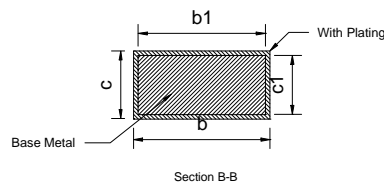
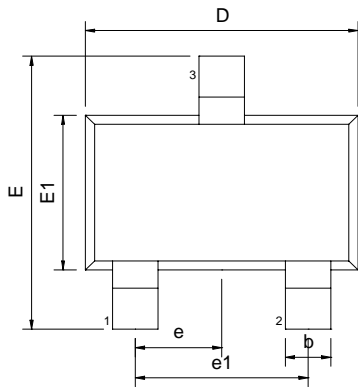

SYMBOLS	DIMENSIONS IN MILLIMETERS			DIMENSIONS IN INCHES		
	MIN	NOM	MAX	MIN	NOM	MAX
A	1.05	---	1.35	0.041	---	0.053
A1	0.05	---	0.15	0.002	---	0.006
A2	1.00	1.10	1.20	0.039	0.043	0.047
b	0.25	---	0.50	0.010	---	0.020
b1	0.25	0.40	0.45	0.010	0.016	0.018
c	0.08	---	0.20	0.003	---	0.008
c1	0.08	0.11	0.15	0.003	0.004	0.006
D	2.70	2.90	3.00	0.106	0.114	0.118
E	2.60	2.80	3.00	0.102	0.110	0.118
E1	1.50	1.60	1.70	0.059	0.063	0.067
L	0.35	0.45	0.55	0.014	0.018	0.022
L1	0.60 REF			0.024 REF		
e	0.95 BSC			0.037 BSC		
e1	1.90 BSC			0.075 BSC		
theta	0°	5°	10°	0°	5°	10°
theta1	3°	5°	7°	3°	5°	7°
theta2	6°	8°	10°	6°	8°	10°

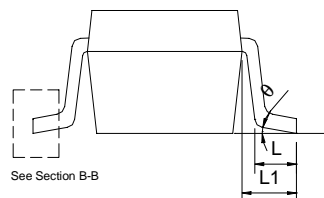
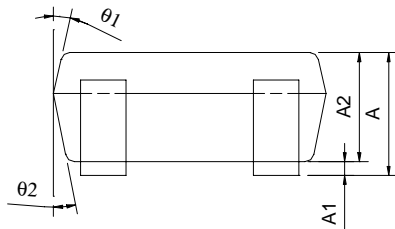

PACKAGE DIMENSION (CONTINUED)

SOT-23-5 (M25)

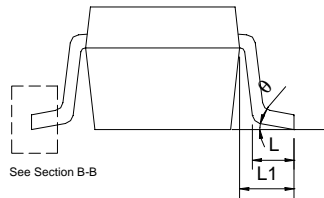
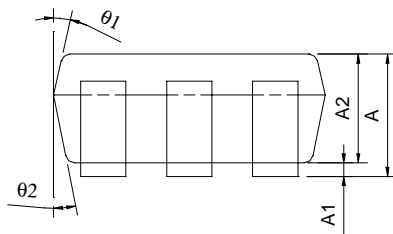
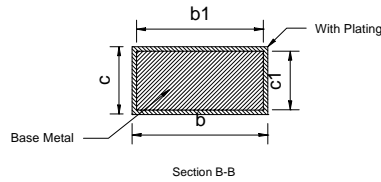
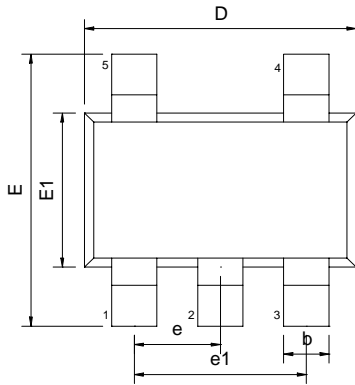

SYMBOLS	DIMENSIONS IN MILLIMETERS			DIMENSIONS IN INCHES		
	MIN	NOM	MAX	MIN	NOM	MAX
A	1.05	---	1.35	0.041	---	0.053
A1	0.05	---	0.15	0.002	---	0.006
A2	1.00	1.10	1.20	0.039	0.043	0.047
b	0.25	---	0.50	0.010	---	0.020
b1	0.25	0.40	0.45	0.010	0.016	0.018
c	0.08	---	0.20	0.003	---	0.008
c1	0.08	0.11	0.15	0.003	0.004	0.006
D	2.70	2.90	3.00	0.106	0.114	0.118
E	2.60	2.80	3.00	0.102	0.110	0.118
E1	1.50	1.60	1.70	0.059	0.063	0.067
L	0.35	0.45	0.55	0.014	0.018	0.022
L1	0.60 REF			0.024 REF		
e	0.95 BSC			0.037 BSC		
e1	1.90 BSC			0.075 BSC		
theta	0°	5°	10°	0°	5°	10°
theta1	3°	5°	7°	3°	5°	7°
theta2	6°	8°	10°	6°	8°	10°

SOT-89 (M89)

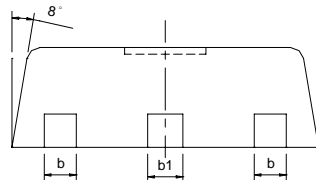
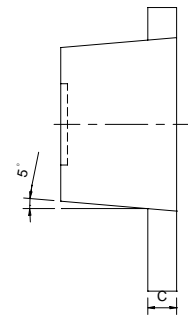
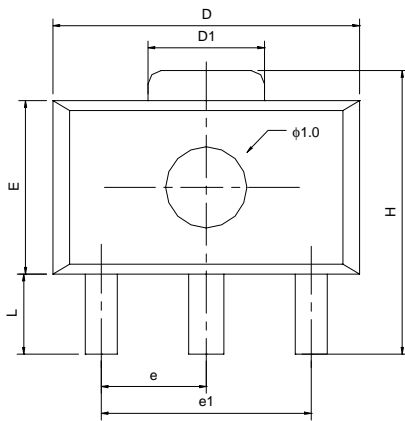

SYMBOLS	DIMENSIONS IN MILLIMETERS			DIMENSIONS IN INCHES		
	MIN	NOM	MAX	MIN	NOM	MAX
A	1.40	1.50	1.60	0.055	0.059	0.063
L	0.80	---	1.20	0.031	---	0.047
b	0.36	0.42	0.48	0.014	0.016	0.018
b1	0.41	0.47	0.53	0.016	0.018	0.020
c	0.38	0.40	0.43	0.014	0.015	0.017
D	4.40	4.50	4.60	0.173	0.177	0.181
D1	1.40	1.60	1.75	0.055	0.062	0.069
H	3.94	---	4.25	0.155	---	0.167
E	2.40	2.50	2.60	0.094	0.098	0.102
e1	2.90	3.00	3.10	0.114	0.118	0.122
e	1.45	1.50	1.55	0.057	0.059	0.061

NUMBERING SCHEME

Ordering Number: CM2830XYZ/CM2830AXYZ (note1)

note1:

CM2830/CM2830A : 300mA CMOS LDO

X : Suffix for voltage output (note 2)

Y : Suffix for Temperature Range (note 3)

Z : Suffix for Package Type (note 4)

note 2: see CMOS LDO Voltage Suffix Table

CM2830/A will provide options of A (1.5V), D(1.8V), E (1.9V), F(2.0V), H (2.2V), K(2.5V), M(2.7V), N(2.8V), O (2.9V), P(3.0V), S(3.3V), U(3.5V), V(3.6V), X(3.8V)

note 3:

Y= I : -40°C ~+85°C (only I grade support for all CMOS LDOs)

note 4:

Z is single alphabet with or without digits

M23 : SOT-23 (TR only)

N92 : TO-92 (TA only)

M25 : SOT-25 (TR only)

M89 : SOT-89 (TR only)

CMOS LDO Voltage Suffix Table

Output Voltage	Suffix	Output Voltage	Suffix
1.5V	A	3.0V	P
1.6V	B	3.1V	Q
1.7V	C	3.2V	R
1.8V	D	3.3V	S
1.9V	E	3.4V	T
2.0V	F	3.5V	U
2.1V	G	3.6V	V
2.2V	H	3.7V	W
2.3V	I	3.8V	X
2.4V	J	3.9V	Y
2.5V	K	4.0V	Z
2.6V	L		
2.7V	M		
2.8V	N		
2.9V	O		

上海台永商貿有限公司



SHANGHAI SALES DEPT.

上海台永商貿有限公司
SHANGHAI TAIYONG CO.,LTD
上海市普陀區桐柏路 165 弄 1 號
101-103 室

(上海)TEL:86-21-59512136

(上海)FAX:86-21-59512123

E-mail:

shanghai@shanghai-taiyong.com

E-mail:

shanghai@vny-gsm.com



INVERTER LAB & Sales Dept . DONG-GUAN,CHINA

東省東莞市長安鎮烏沙江貝村同和
四巷 15 號

(東莞) TEL:86-769-5373287

(東莞) FAX:86-769-5373286

E-mail:

dong-guan@shanghai-taiyong.com

E-mail:

dong-guan@vny-gsm.com



CERAMIC/SURGE ABSORBER SHANGHAI,CHINA



DIODES LAB HANGZHOU,CHINA



CERAMIC/PZT SHINCHU,TAIWAN



DC POWER LAB TAIPEI,TAIWAN