



1233

LINEAR INTEGRATED CIRCUIT

DUAL 3-W BTL AUDIO POWER AMPLIFIER

■ DESCRIPTION

The UTC 1233 is an audio power amplifier IC for the stereo system. In the BTL (balanced transformerless) method, fewer external parts and easier design for applications are required.

■ FEATURES

- * 3-W output (8) with supply voltage of 8V
- * On-chip standby function
- * On-chip volume function

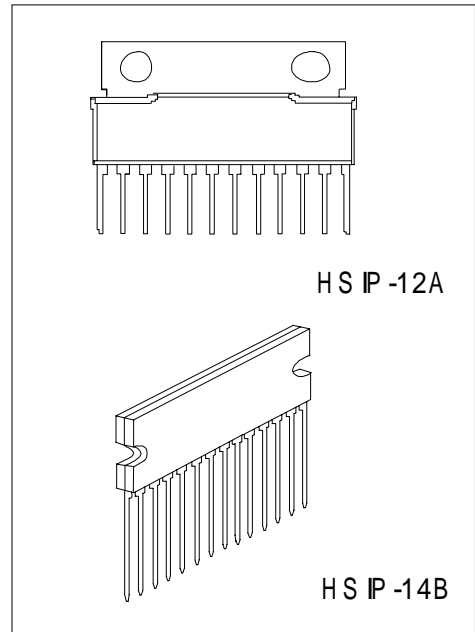

*Pb-free plating product number: 1233L

■ ORDERING INFORMATION

Ordering Number		Package	Packing
Normal	Lead Free Plating		
1233-F12-T	1233L-F12-T	HSIP-12A	Tube
1233-H14-B-T	1233L-H14-B-T	HSIP-14B	Tube

■ PIN DESCRIPTION

PIN NO.		PIN NAME	DESCRIPTION
HSIP-12A	HSIP-14B		
	1	NC	No connect
1	2	V _{CC}	Supply voltage
2	3	Ch.1+ output	Ch.1+ output
3	4	GND	Ground (output ch.1)
4	5	Ch.1- output	Ch.1 - output
5	6	Standby	Standby (standby state if this pin is open)
6	7	Ch.1 input	Ch.1 input
7	8	GND	Ground (input)
8	9	Ch.2 input	Ch.2 input
9	10	Volume	Volume (max. volume if this pin is open.)
10	11	Ch.2- output	Ch.2 - output
11	12	GND	Ground (output ch.2)
12	13	Ch.2+ output	Ch.2 + output
	14	NC	No connect

■ BLOCK DIAGRAM

HSIP-12A

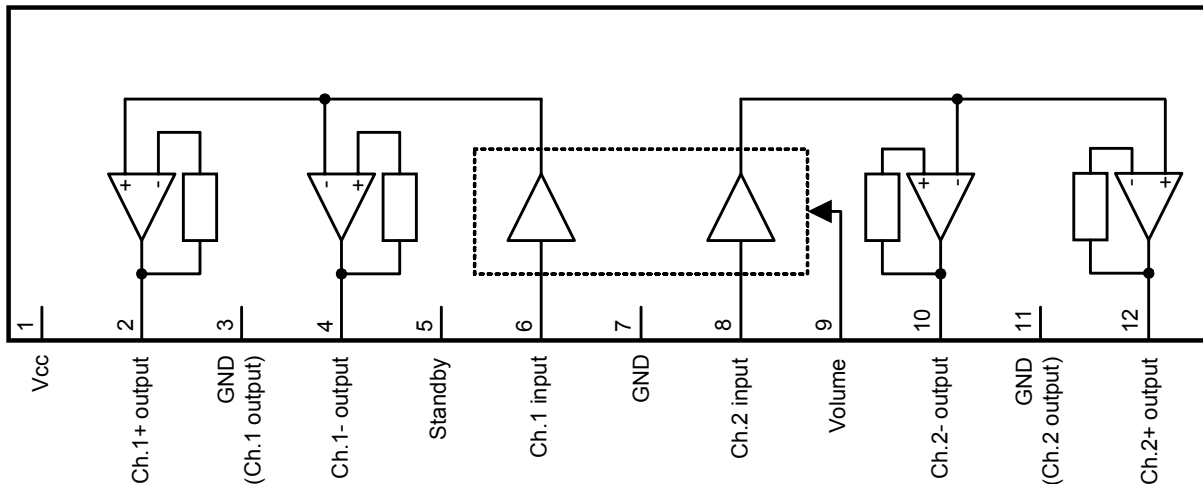

HSIP-14B

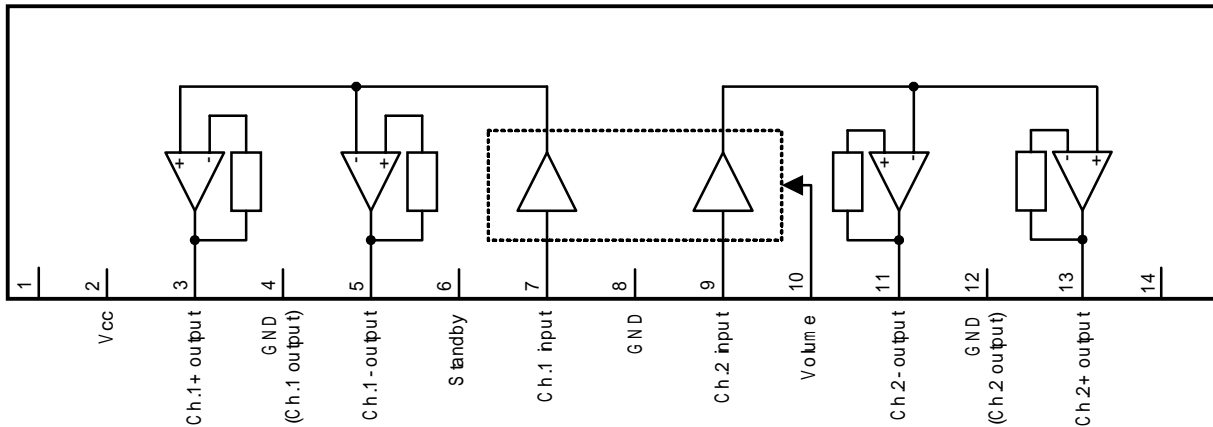

■ ABSOLUTE MAXIMUM RATINGS (Ta = 25 °C)

PARAMETER	SYMBOL	RATINGS	UNIT
Supply Voltage (At no signal)	V _{CC}	14	V
Supply Current	I _{CC}	2.0	A
Power Dissipation(Ta = 70 °C)	P _D	1.92	W
Operating Temperature	T _{OPR}	0 ~ +70	°C
Storage Temperature	T _{STG}	-40 ~ +150	°C

Note:1.Absolute maximum ratings are those values beyond which the device could be permanently damaged.

Absolute maximum ratings are stress ratings only and functional device operation is not implied.

2.The device is guaranteed to meet performance specification within 0 ~70 °C operating temperature range and assured by design from -40 ~85 °C.

■ RECOMMENDED OPERATING RATINGS

PARAMETER	SYMBOL	RATINGS	UNIT
Supply voltage	V _{CC}	3.5 ~ 13.5	V

■ ELECTRICAL CHARACTERISTICS

(V_{CC}=8.0V, R_L=8 Ω, f=1kHz, Ta=25 °C ±2 °C, unless otherwise specified.)

PARAMETER	SYMBOL	TEST CONDITIONS	MIN	TYP	MAX	UNIT
Quiescent Circuit Current	I _D	V _{IN} =0mV, V _{O1} =0V		45	100	mA
Standby Current	I _{STN-BY}	V _{IN} =0mV, V _{O1} =0V		1	10	μA
Output Noise Voltage*	V _{NO}	R _G =10kΩ, V _{O1} =0V		0.10	0.4	mV(rms)
Output Offset Voltage	V _{OFF}	R _G =10kΩ, V _{O1} =0V	-250	0	250	mV
Total Harmonic Distortion	THD	P _{OUT} =0.5W, V _{O1} =1.25V		0.10	0.5	%
Maximum Output Power	P _{OUT1}	THD=10%, V _{O1} =1.25V	2.4	3.0		W
Ripple Rejection*	RR	R _G =10kΩ, V _{O1} =0V V _R =1V(rms), f _R =120Hz	30	50		dB
Voltage Gain	G _V	P _{OUT} =0.5W, V _{O1} =1.25V	31	33	35	dB
Volume Attenuation Rate*	Att	P _{OUT} =0.5W, V _{O1} =0V	70	85		dB
Channel Balance 1	CB1	P _{OUT} =0.5W, V _{O1} =1.25V	-1	0	1	dB
Channel Balance 2	CB2	P _{OUT} =0.5W, V _{O1} =0.6V	-3	0	3	dB
Intermediate Voltage Gain	G _{VM}	P _{OUT} =0.5W, V _{O1} =0.6V	20.5	23.5	26.5	dB
Channel Crosstalk	C _T	P _{OUT} =0.5W, V _{O1} =1.25V	40	55		dB

* In measuring, the filter for the range of 15 Hz ~ 30 kHz (12 dB/OCT) is used.

■ TERMINAL EQUIVALENT CIRCUITS AT $V_{CC}=8V$

PIN NO.		PIN NAME	VOLTAGE
HSIP-12A	HSIP-14B		
1	2	Vcc	8V
2	3	Ch.1 + output pin	3.6V (at no signal)
3	4	GND	0V
4	5	Ch.1 - output pin	3.6V (at no signal)
5	6	Standby pin	0V or 5V (Standby off at supply 5V. Standby at 0.4V less or open.)
6	7	Ch.1 input pin	1.4V (Input circuit bias voltage is output)
7	8	GND	0V
8	9	Ch.2 input pin	1.4V (Input circuit bias voltage is output)
9	10	Volume pin	Supply to 0V ~ 1.25V
10	11	Ch.2-output pin	3.6V (at no signal)
11	12	GND	0V
12	13	Ch.2+ output pin	3.6V (at no signal)

■ USAGE NOTES

- * Please avoid the short-circuits to V_{CC} , ground, or load short-circuit.
- * Please connect the cooling fin with the GND potential.
- * The thermal shutdown circuit operates at about $T_J=150^\circ$. However, the thermal shutdown circuit is reset automatically if the temperature drops.
- * Please carefully design the heat radiation especially when you take out high power at high V_{CC} .
- * Please connect only the ground of signal with the signal GND of the amplifier in the previous stage.

■ APPLICATION CIRCUIT EXAMPLE

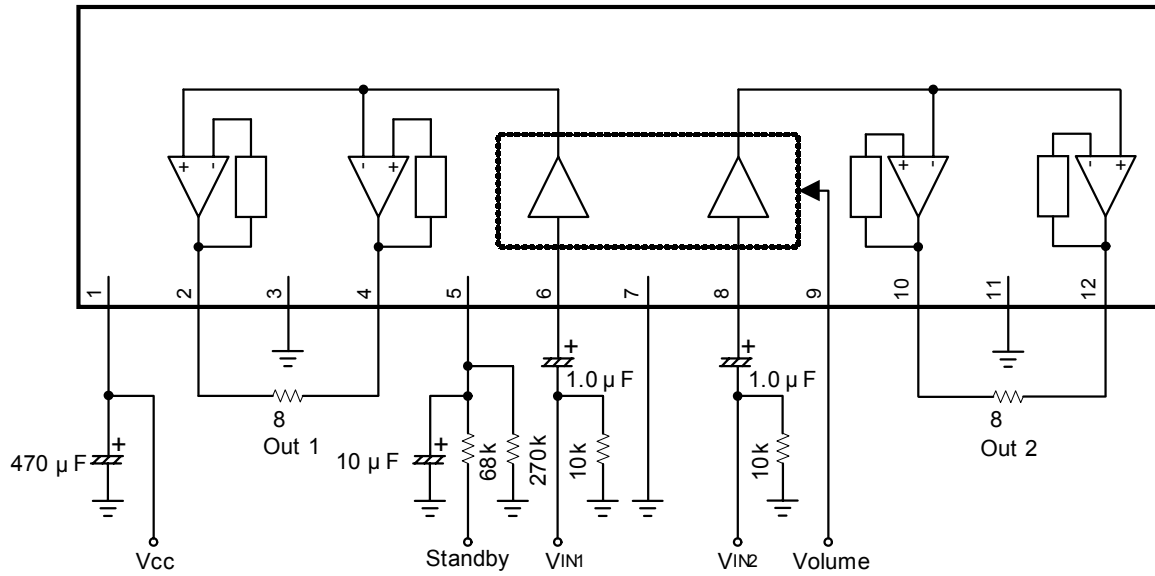

■ TECHNICAL DATA (HSIP-12A)

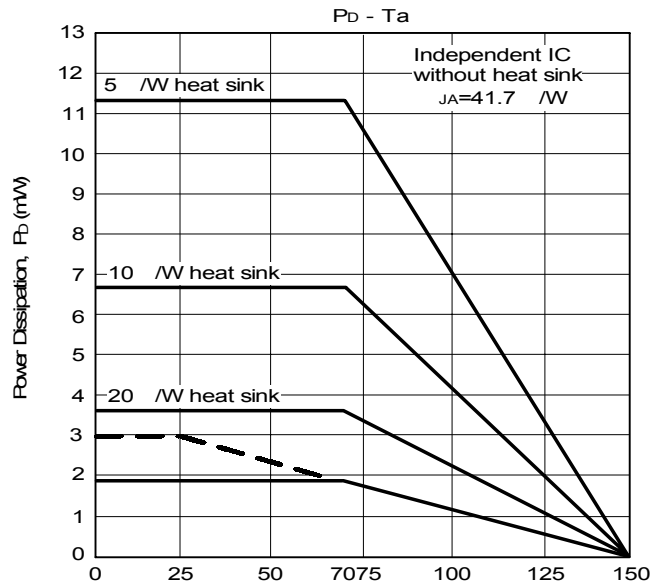

■ TYPICAL MAIN CHARACTERISTICS

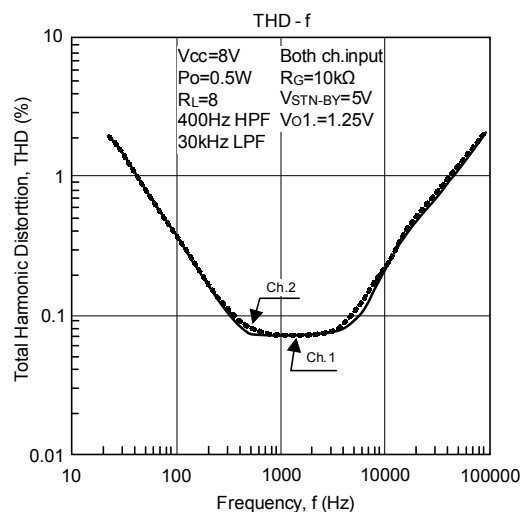
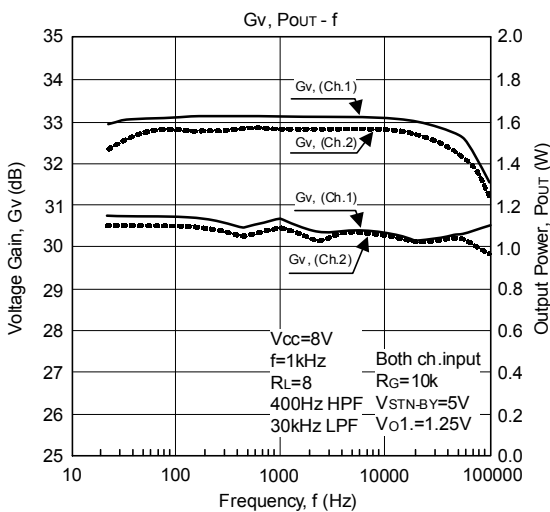
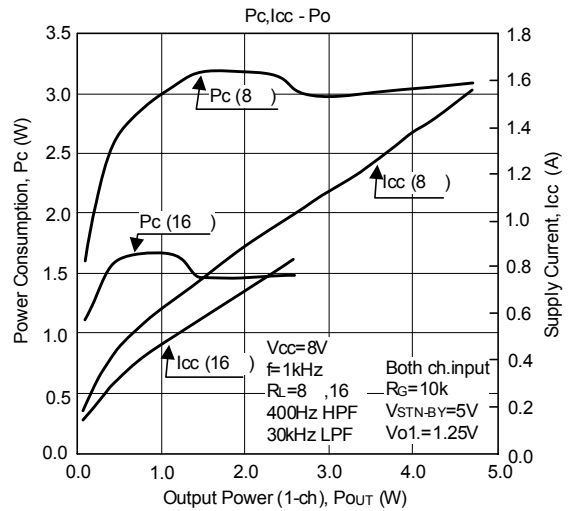
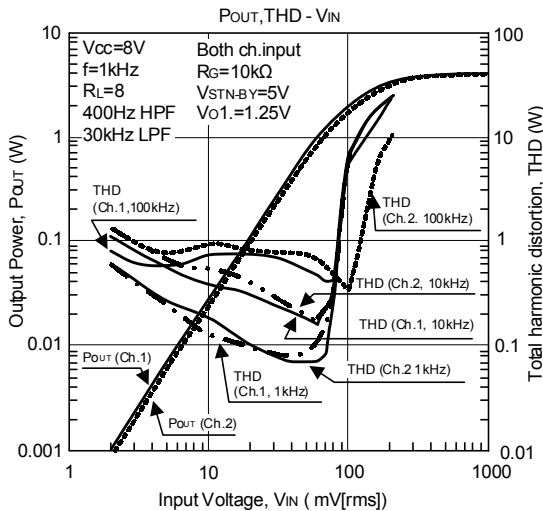
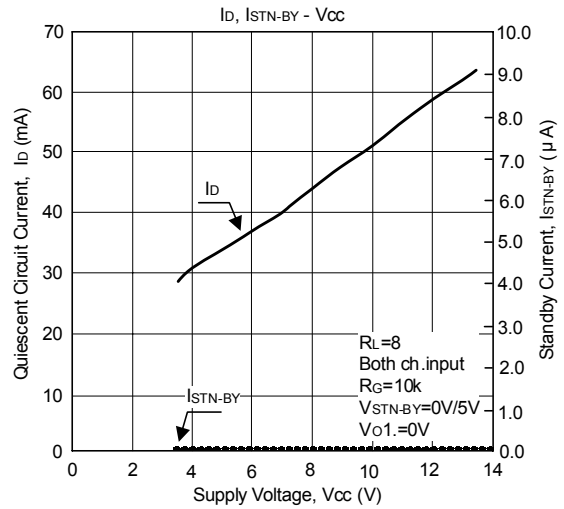
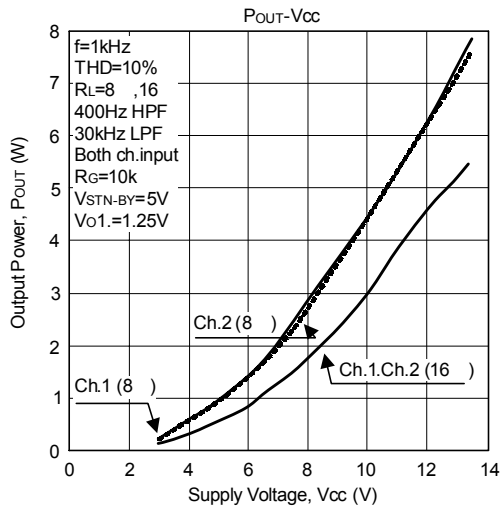

■ TYPICAL MAIN CHARACTERISTICS (cont.)

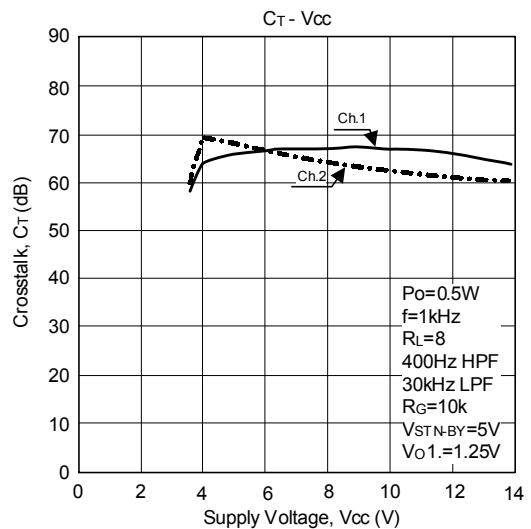
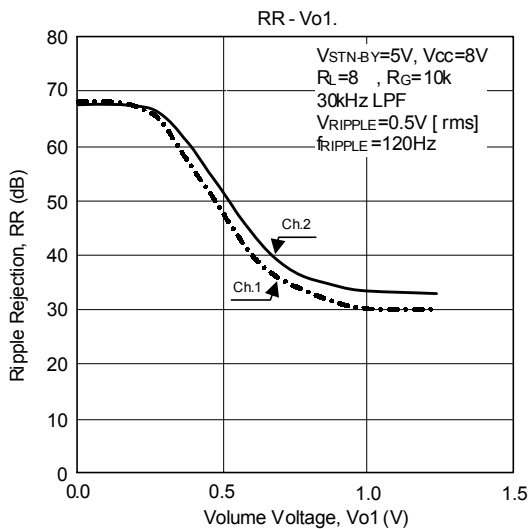
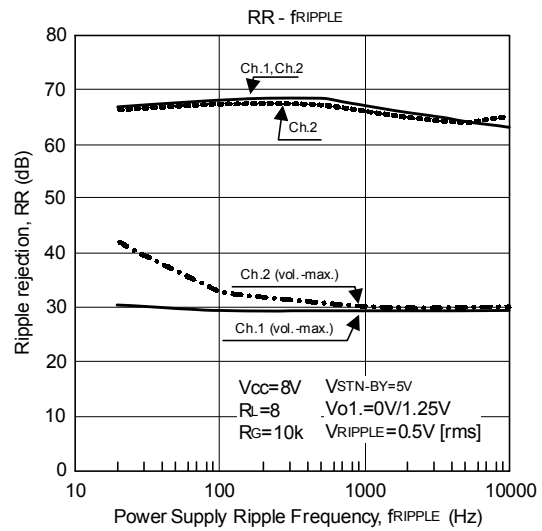
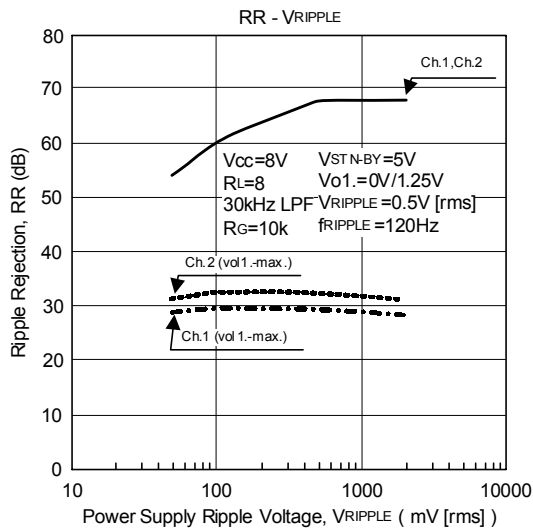
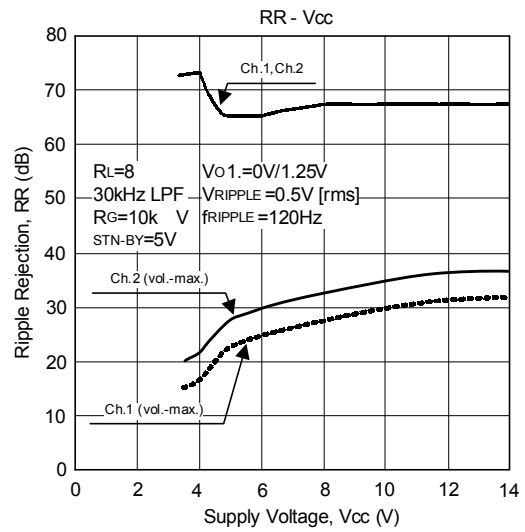
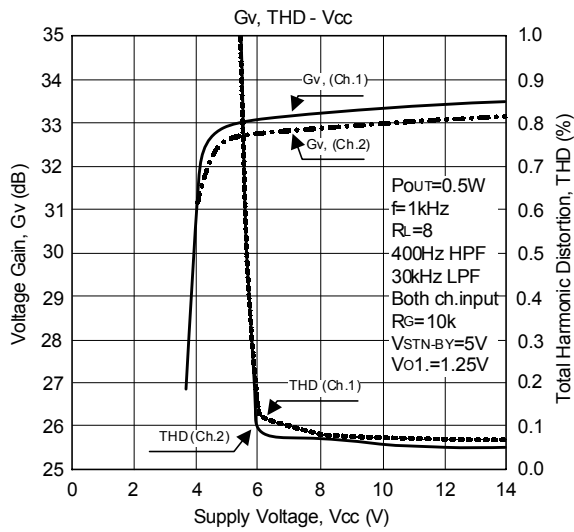

■ TYPICAL MAIN CHARACTERISTICS (cont.)

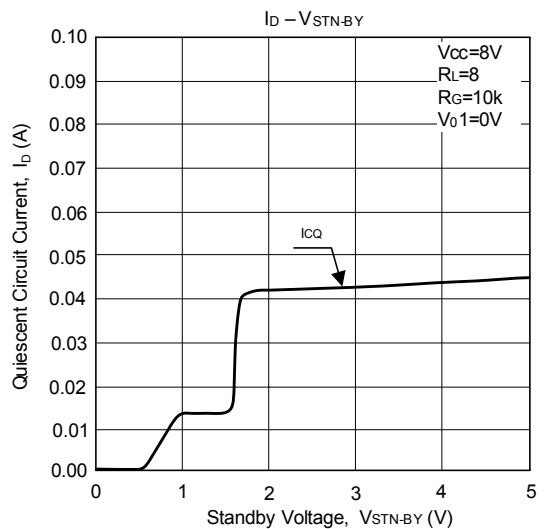
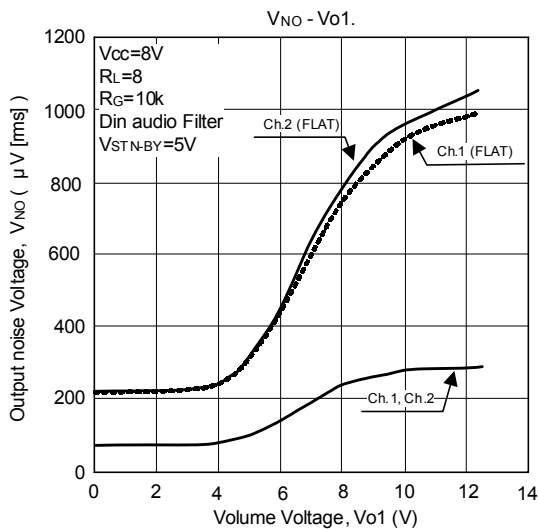
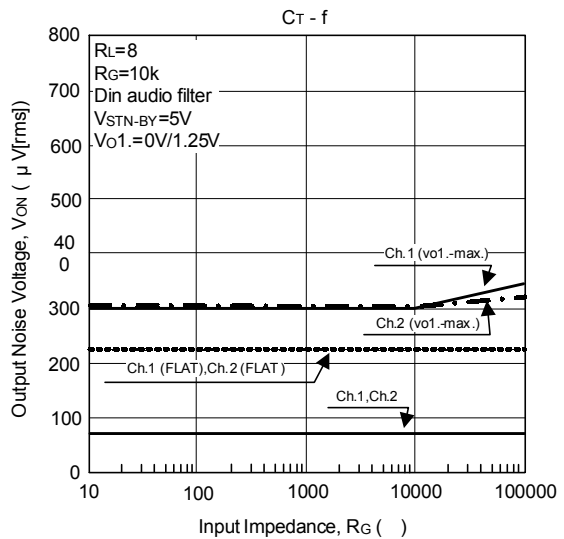
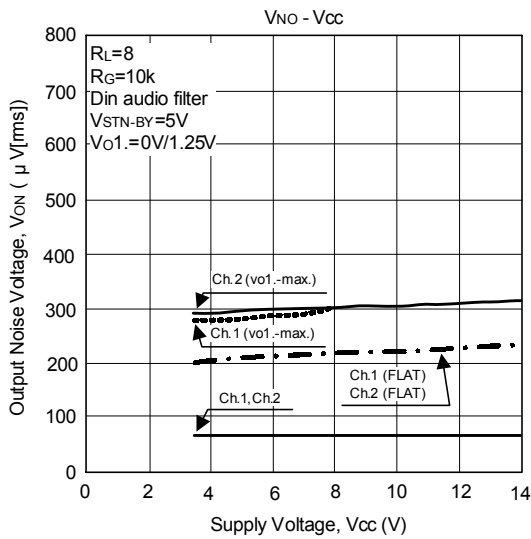
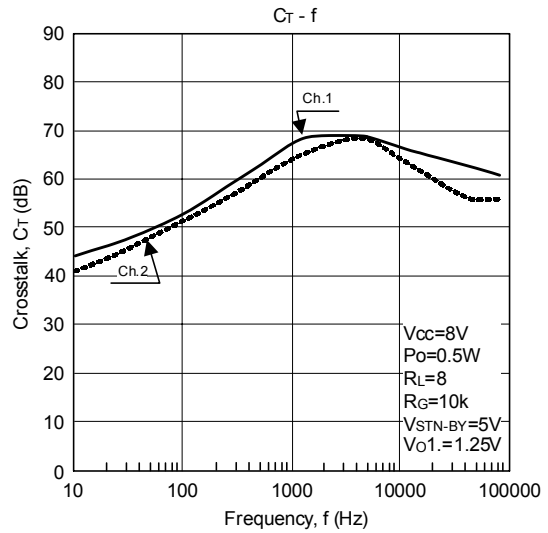
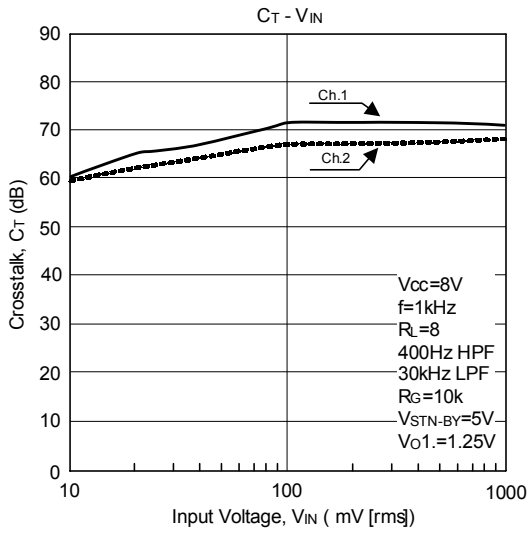

■ TYPICAL MAIN CHARACTERISTICS (cont.)

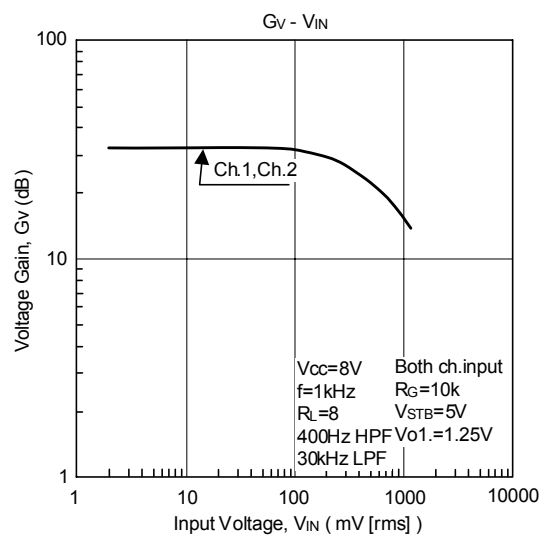
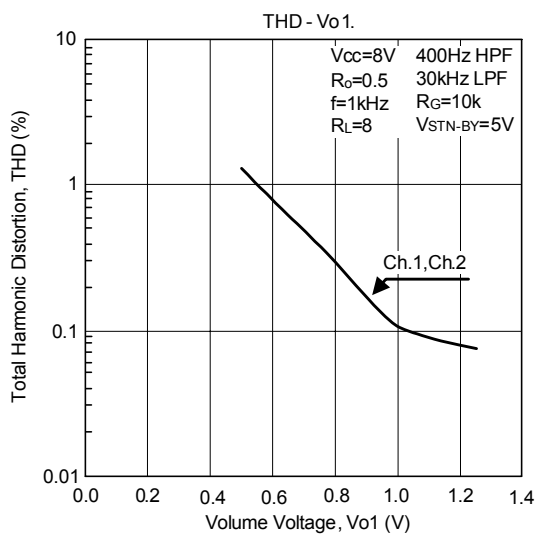
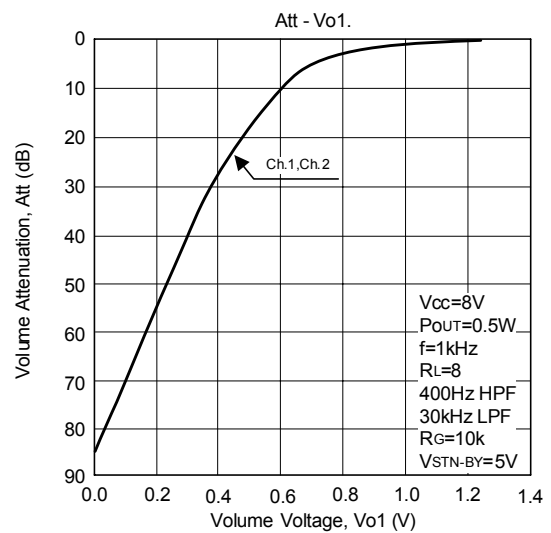
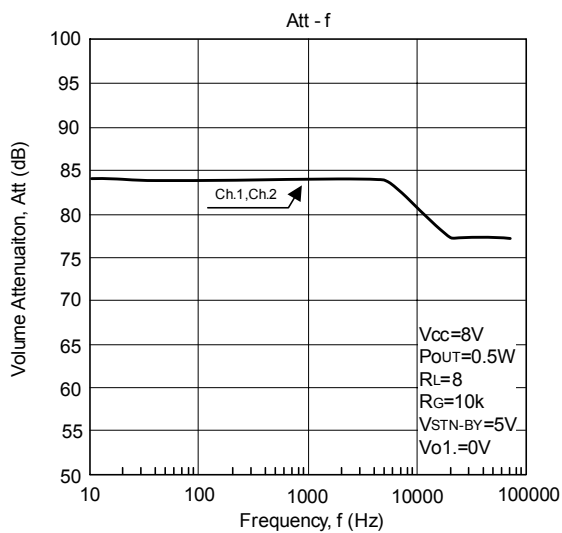
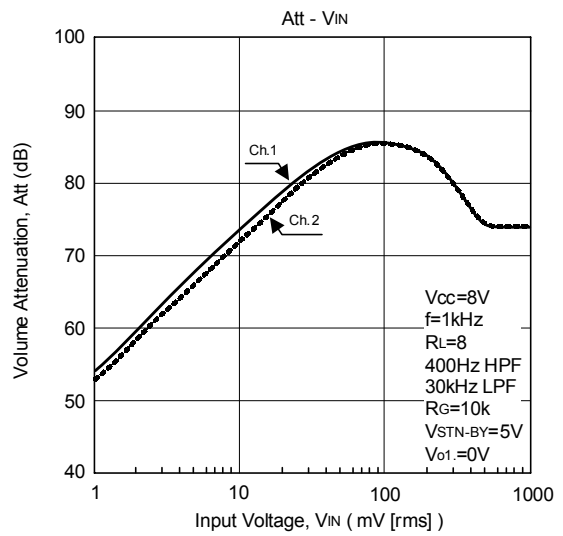
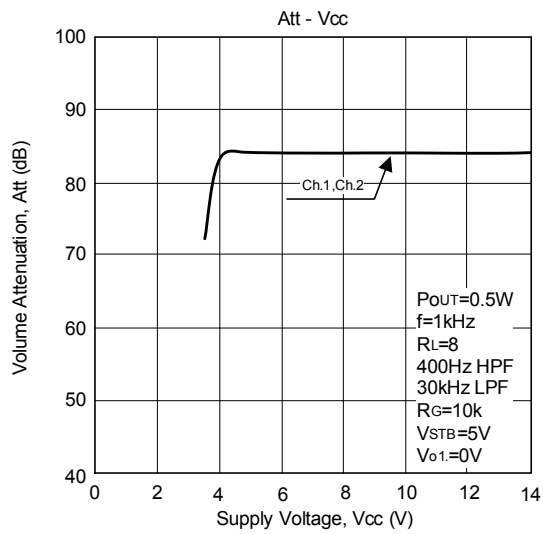

UTC assumes no responsibility for equipment failures that result from using products at values that exceed, even momentarily, rated values (such as maximum ratings, operating condition ranges, or other parameters) listed in products specifications of any and all UTC products described or contained herein. UTC products are not designed for use in life support appliances, devices or systems where malfunction of these products can be reasonably expected to result in personal injury. Reproduction in whole or in part is prohibited without the prior written consent of the copyright owner. The information presented in this document does not form part of any quotation or contract, is believed to be accurate and reliable and may be changed without notice.