

CMOS Decade Counter/Divider

Plus 10 Decoded Decimal Outputs

The RCA-CD4017A consists of a 5-stage Johnson decade counter and an output decoder which converts the Johnson binary code to a decimal number. Inputs include a CLOCK, a RESET, and a CLOCK INHIBIT signal.

The decade counter is advanced one count at the positive clock signal transition if the CLOCK INHIBIT signal is low. Counter advancement via the clock line is inhibited when the clock INHIBIT signal is high. A high reset signal clears the decade counter to

its zero count. Use of the Johnson decade counter configuration permits high speed operation, 2-input decimal decode gating, and spike-free decoded outputs. Anti-lock gating is provided, thus assuring proper counting sequence. The 10 decoded outputs are normally low and go high only at their respective decimal time slot. Each decoded output remains high for one full clock cycle. A CARRY-OUT (COUT) signal completes one cycle every 10 clock input cycles and is used to clock the succeeding decade directly in a multi-decade counting chain.

These types are supplied in 16-lead hermetic dual-in-line ceramic packages (D and F suffixes), 16-lead dual-in-line plastic packages (E suffix), 16-lead ceramic flat packages (K suffix), and in chip form (H suffix).

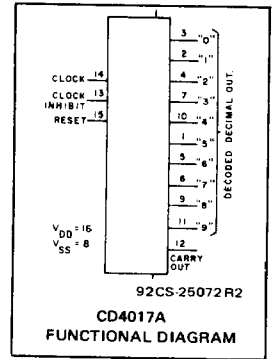

MAXIMUM RATINGS, Absolute-Maximum Values:

STORAGE-TEMPERATURE RANGE (T_{stg})	-65 to +150°C
OPERATING-TEMPERATURE RANGE (T_A):	
PACKAGE TYPES D, F, K, H	-55 to +125°C
PACKAGE TYPE E	-40 to +85°C
DC SUPPLY-VOLTAGE RANGE (V_{DD})	
(Voltages referenced to V_{SS} Terminal)	-0.5 to +15 V
POWER DISSIPATION PER PACKAGE (P_D):	
FOR $T_A = -40$ to $+60^\circ\text{C}$ (PACKAGE TYPE E)	500 mW
FOR $T_A = +60$ to $+85^\circ\text{C}$ (PACKAGE TYPE E)	Derate Linearly at 12 mW/°C to 200 mW
FOR $T_A = -55$ to $+100^\circ\text{C}$ (PACKAGE TYPES D, F, K)	500 mW
FOR $T_A = +100$ to $+125^\circ\text{C}$ (PACKAGE TYPES D, F, K)	Derate Linearly at 12 mW/°C to 200 mW
DEVICE DISSIPATION PER OUTPUT TRANSISTOR	
FOR $T_A = \text{FULL PACKAGE-TEMPERATURE RANGE (ALL PACKAGE TYPES)}$	100 mW
INPUT VOLTAGE RANGE, ALL INPUTS	-0.5 to $V_{DD} + 0.5$ V
LEAD TEMPERATURE (DURING SOLDERING):	
At distance 1/16 ± 1/32 inch (1.59 ± 0.79 mm) from case for 10 s max.	+265°C

Features:

- Synchronous decade counter plus 10 decoded outputs
- Fully static operation
- Medium speed operation. 5 MHz (typ.) at $V_{DD} - V_{SS} = 10$ V
- Quiescent current specified to 15 V
- Maximum input leakage current of 1 μA at 15 V (full package-temperature range)
- 1-V noise margin (full package-temperature range)

Applications:

- Decade counter/decimal decode display
- Frequency division
- Counter control/timers
- Divide by N counting
N = 2 - 10 with one CD4017A and one one CD4001A
N > 10 with multiple CD4017A's
- For further application information, see ICAN-6166 "CMOS MSI Counter and Register Design & Applications"

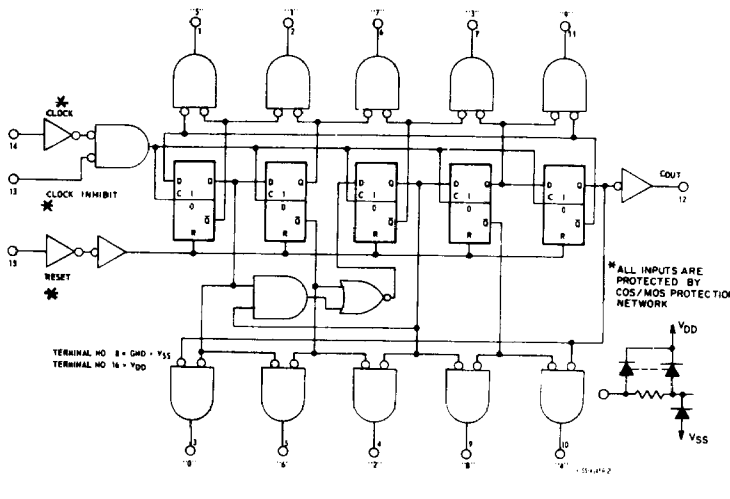

Fig. 1 - Logic diagram.

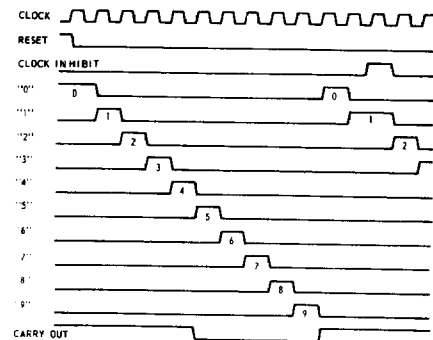

Fig. 2 - Timing diagram.

CD4017A Types

STATIC ELECTRICAL CHARACTERISTICS

CHARACTERISTICS	CONDITIONS			LIMITS AT INDICATED TEMPERATURES (°C)								UNITS			
	V _O (V)	V _{IN} (V)	V _{DD} (V)	D, F, K, H PACKAGES				E PACKAGE							
				-55	+25		+125	-40	+25		+85				
Quiescent Device Current, I _L Max.	-	-	5	5	0.3	5	300	50	0.5	50	700	μA			
	-	-	10	10	0.5	10	600	100	1	100	1400				
	-	-	15	50	1	50	2000	500	5	500	5000				
Output Voltage: Low-Level, V _{OL}	-	5	5	0 Typ.; 0.05 Max.								V			
	-	10	10	0 Typ.; 0.05 Max.											
	-	0	5	4.95 Min.; 5 Typ.											
High Level V _{OH}	-	0	5	9.95 Min.; 10 Typ.								V			
	-	0	10	9.95 Min.; 10 Typ.											
Noise Immunity: Inputs Low, V _{NL}	4.2	-	5	1.5 Min.; 2.25 Typ.								V			
	9	-	10	3 Min.; 4.5 Typ.											
	0.8	-	5	1.5 Min.; 2.25 Typ.											
Inputs High V _{NH}	1	-	10	3 Min.; 4.5 Typ.								V			
	4.5	-	5	1 Min.											
Noise Margin Inputs Low V _{NML}	9	-	10	1 Min.								V			
	0.5	-	5	1 Min.											
Inputs High, V _{NMH}	1	-	10	1 Min.								V			
	0.5	-	5	1 Min.											
Output Drive Current: N-Channel (Sink)	I _{DN} Min	Decoded Outputs	0.5	-	5	0.06	0.1	0.05	0.035	0.03	0.1	0.025	0.02	mA	
			0.5	-	10	0.12	0.4	0.1	0.07	0.085	0.4	0.07	0.055		
		Carry Output	0.5	-	5	0.185	0.4	0.15	0.105	0.095	0.4	0.08	0.065		
			0.5	-	10	0.45	1	0.35	0.25	0.3	1	0.25	0.2		
		P-Channel (Source)	Decoded Outputs	4.5	-	5	-0.0375	-0.075	-0.03	-0.021	-0.018	-0.075	-0.015		-0.012
				9.5	-	10	-0.12	-0.2	-0.1	-0.07	-0.085	-0.2	-0.07		-0.055
	Carry Output		4.5	-	5	-0.185	-0.4	-0.15	-0.105	-0.095	-0.4	-0.08	-0.065		
			9.5	-	10	-0.45	-1	-0.35	-0.25	-0.3	-1	-0.24	-0.20		
	Input Leakage Current, I _L , I _H		Any Input		15	±10 ⁻⁵ Typ., ±1 Max.									μA
			-	-	15	±10 ⁻⁵ Typ., ±1 Max.									

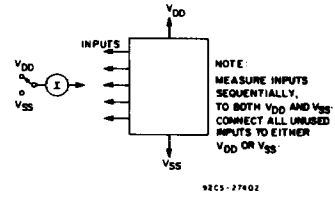

Fig. 10 - Input-leakage-current test circuit.

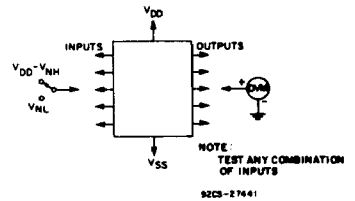

Fig. 11 - Noise-immunity test circuit.

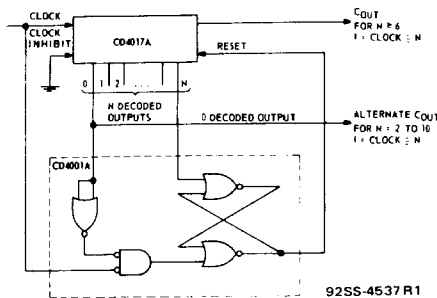

Fig. 12 - Divide by N counter (N ≤ 10) with N decoded outputs.

When the Nth decoded output is reached (Nth clock pulse) the S-R flip flop (constructed from two NOR gates of the CD4001A) generates a reset pulse which clears the CD4017A to its zero count. At this time, if the Nth decoded output is greater than or equal to 6, the C_{OUT} line goes high to clock the next CD4017A counter section. The "0" decoded output also goes high at this time. Coincidence of the clock low and decoded "0" output low resets the S-R flip flop to enable the CD4017A. If the Nth decoded output is less than 6, the C_{OUT} line will not go high and, therefore, cannot be used. In this case "0" decoded output may be used to perform the clocking function for the next counter.

CD4017A Types

RECOMMENDED OPERATING CONDITIONS at $T_A = 25^\circ\text{C}$, Except as Noted.
 For maximum reliability, nominal operating conditions should be selected so that operation is always within the following ranges:

CHARACTERISTIC	V_{DD} (V)	LIMITS				UNITS
		D, F, K, H PACKAGES		E PACKAGE		
		MIN.	MAX.	MIN.	MAX.	
Supply Voltage Range (For $T_A = \text{Full Package-Temperature Range}$)		3	12	3	12	V
Clock Inhibit Setup Time, t_S	5 10	500 200	— —	700 300	— —	ns
Clock Pulse Width, t_W	5 10	500 170	— —	830 250	— —	ns
Clock Input Frequency, f_{CL}	5 10	dc dc	1 3	dc dc	0.6 2	MHz
Clock Rise or Fall Time, t_{rCL} , t_{fCL}	5 10	— —	15 15	— —	15 15	μs
Reset Pulse Width, t_W	5 10	500 165	— —	830 250	— —	ns
Reset Removal Time	5 10	750 225	— —	1000 275	— —	ns

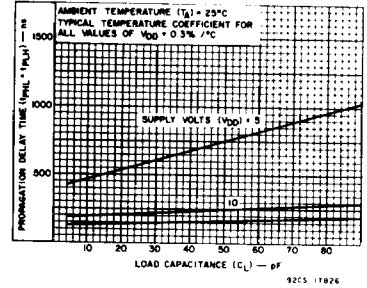

Fig. 3 — Typical propagation delay time vs. C_L for decoded outputs.

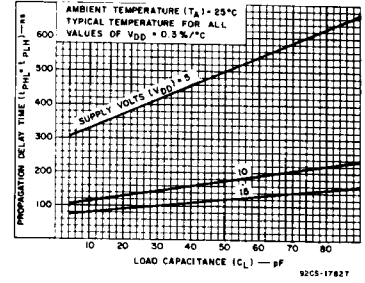

Fig. 4 — Typical propagation delay time vs. C_L for carry output.

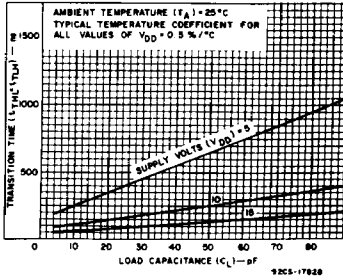

Fig. 5 — Typical transition time vs. C_L for decoded outputs.

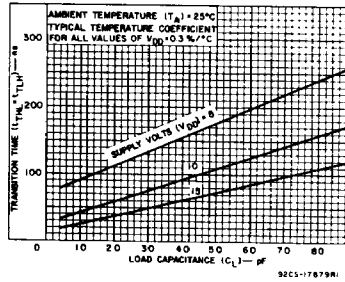

Fig. 6 — Typical transition time vs. C_L for carry output.

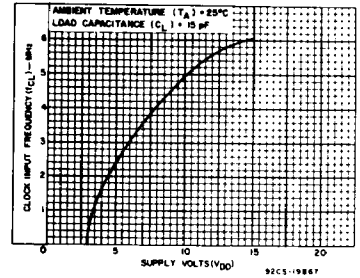

Fig. 7 — Typical clock input frequency vs. V_{DD} .

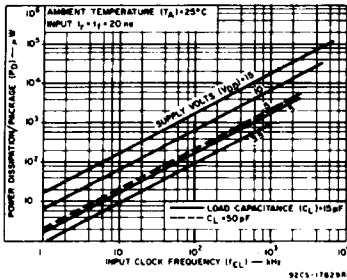

Fig. 8 — Typical dissipation characteristics.

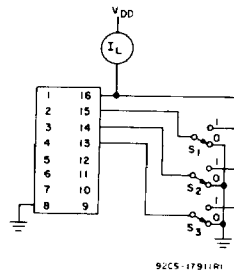

Fig. 9 — Quiescent device current test circuit.

Test performed with the following sequence of "1's and "0's" at each switch.

S1	S2	S3	S1	S2	S3
1	1	1	0	1	0
0	0	0	0	0	0
0	1	0	0	1	0
0	0	0	0	0	0
0	1	0	0	1	0
0	0	0	0	0	0
0	1	0	0	1	0

CD4017A Types

DYNAMIC ELECTRICAL CHARACTERISTICS

At $T_A = 25^\circ\text{C}$, Input $t_r, t_f = 20\text{ ns}$, $C_L = 15\text{ pF}$, $R_L = 200\text{ k}\Omega$

CHARACTERISTIC	TEST CONDITIONS	LIMITS						UNITS	
		V _{DD} (V)	D, F, K, H PACKAGES			E PACKAGE			
			MIN.	TYP.	MAX.	MIN.	TYP.		MAX.
CLOCKED OPERATION									
Propagation Delay Time; t _{PHL} t _{PLH}		5	–	350	1000	–	350	1300	ns
		10	–	125	250	–	125	300	
Carry Out Line		5	–	500	1200	–	500	1600	
		10	–	200	400	–	200	500	
Decode Out Lines		5	–	100	300	–	100	350	
		10	–	50	150	–	50	200	
Transition Time; t _{THL} t _{TLH}		5	–	300	900	–	300	1200	ns
		10	–	125	350	–	125	450	
Carry Out Line		5	1	2.5	–	0.6	2.5	–	MHz
		10	3	5	–	2	5	–	
Decode Out Lines		5	–	200	500	–	200	830	ns
		10	–	100	170	–	100	250	
Maximum Clock Input Frequency, f _{CL} *		5	–	–	15	–	–	15	μs
		10	–	–	15	–	–	15	
Minimum Clock Pulse Width, t _w		5	–	175	500	–	175	700	ns
		10	–	75	200	–	75	300	
Clock Rise & Fall Time; t _{rCL} , t _{fCL}		5	–	–	–	–	–	–	pF
		10	–	–	–	–	–	–	
Average Input Capacitance, C _I	Any Input	–	5	–	–	5	–		
RESET OPERATION									
Propagation Delay Time; t _{PHL}		5	–	350	1000	–	350	1300	ns
		10	–	125	250	–	125	300	
To Carry Out Line		5	–	450	1200	–	450	1600	
		10	–	200	400	–	200	500	
To Decode Out Lines		5	–	200	500	–	200	830	
		10	–	100	165	–	100	250	
Minimum Reset Pulse Width, t _w		5	–	300	750	–	300	1000	ns
		10	–	100	225	–	100	275	
Minimum Reset Removal Time		5	–	–	–	–	–	–	ns
		10	–	–	–	–	–	–	

*Measured with respect to carry output line