

SD7005 Fan Controller

Features

- Use 32768 Hz crystal time base.
- Three wind modes : Constant wind, Rhythmical wind, Sleep wind.
- Three wind grades : Soft wind, Medium wind, Strong wind.
- Six types of timing function selection by bonding options.
- Key-in protection function.
- Wide power supply range : 3.0V ~5.5V.
- Low power consumption.
- Summable/Non-summable timer function selection.

General Description

SD7005 is a CMOS LSI designed for use in fan controllers. In the rhythmical wind mode, the wind speed is programmable. For example, it can be programmed to be soft--medium--strong--soft etc. In sleep wind mode, the wind speed is automatically decreasing.

Summable/Non-summable timer function provides more flexible timing choice. Two types of timer steps (0.5 → 1 → 2 → 4 & 1 → 2 → 4 → 8) can also be selected by users.

Type	Option Pin	Summable/Non-summable	Timer	Maximum Time
SD7005-C	Floating/VDD	Non-summable	1→2→4→8 (hours)	8 hour
	GND	Summable	1→2→4→8 (hours)	15 hour
SD7005-D	Floating/VDD	Non-summable	0.5→1→2→4 (hours)	4 hour
	GND	Summable	0.5→1→2→4 (hours)	7.5 hours

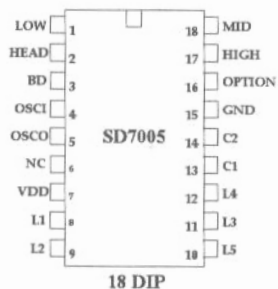
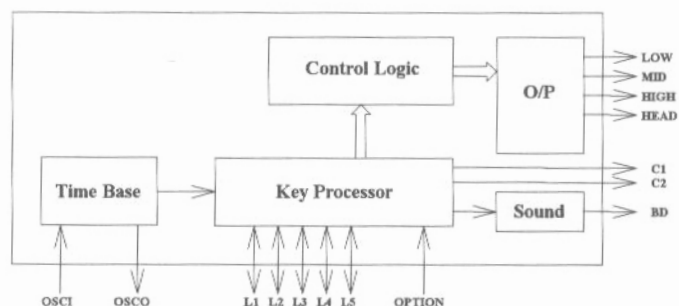
Pin Configuration

SD7005 Block Diagram

Pin Description

Pin No.	Symbol	Description
1	LOW	Soft wind output (driving TRIAC).
2	HEAD	Swing head control output (driving TRIAC).
3	BD	Buzzer output.
4	OSCI	32768 Hz crystal oscillator input.
5	OSCO	32768 Hz crystal oscillator output.
6	NC	For testing.
7	VDD	Positive power supply.
8	L1	Wind speed selector and LED output.
9	L2	Enable swing head and LED output.
10	L5	Chip disable and LED output.
11	L3	Timer setting and LED output.
12	L4	Wind mode selector and LED output.
13	C1	LED pattern common pin 1.
14	C2	LED pattern common pin 2.
15	GND	Negative power supply.
16	OPTION	Summerable/Non-summerable mode selection. Floating/VDD : Non-summerable. GND : Summerable.
17	HIGH	Strong wind output (driving TRIAC).
18	MID	Medium wind output (driving TRIAC).

Absolute Maximum Ratings

RATING	VALUE
DC Supply Voltage	< 5.5V
Input/Output Voltage	GND-0.5V to VDD+0.5V
Operating Temperature	-10° C to 60° C
Storage Temperature	-25° C to 125° C

Notice: Stress greater than those listed under **Absolute Maximum Ratings** may cause permanent damage to the device. This is a stress rating only and functional operation of the device at these or any other conditions above those indicated in the operational sections of this specification is not implied, Exposure to absolute maximum rating conditions for extended period may affect reliability.

Electrical Characteristics

(VDD = 4.5V, GND = 0V, Ta = 25°C, unless otherwise specified)

Parameter	Symbol	Min.	Type.	Max.	Condition
Operating Voltage	Vdd	3.0V	4.5V	5.0V	
Current On TRIAC Driver Pin	ITRIAC	---	10mA	---	Vout=3V
Current On LED Driver Pin	Idriving	---	6mA	---	Vout=3V
Current On C1, C2 Pin	Isinking	---	33mA	---	Vout=1.5V
Current On BD Pin	Idriving & Isinking	---	2mA	---	
Crystal Oscillator Frequency	Freq.	---	32768 Hz	---	

Operation Function

SD7005 has five control inputs : Turn off, Wind speed, Wind mode, Timer setting, Head swing. The control signal can be input by the keypads. When the control signals besides "Turn off" are received, the control system echoes an "Bi" voice. If any two keys or more are simultaneously pressed, neither of the corresponding functions will be activated. If any key is kept on depressing over 6 seconds, the fan controller will automatically echo four warning "Bi"s and power off.

The "Speed" starts the fan, then the speed is at "Strong Wind" for 3 second and then change to "Soft Wind" . Pushing "Speed" key, the sequence of the wind speed is "Soft → Medium → Strong". The sequence of the "Mode" is "Constant → Rhythmical → Sleep". Detailed function graph is shown below.

Function Graph

- Rhythmical Wind mode programmed with speed : ($t = 6\text{sec}$)

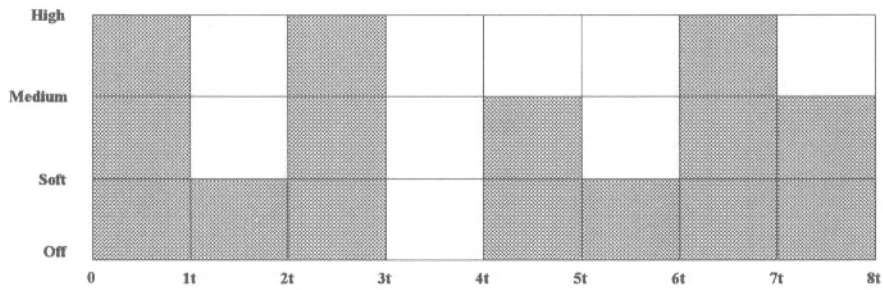
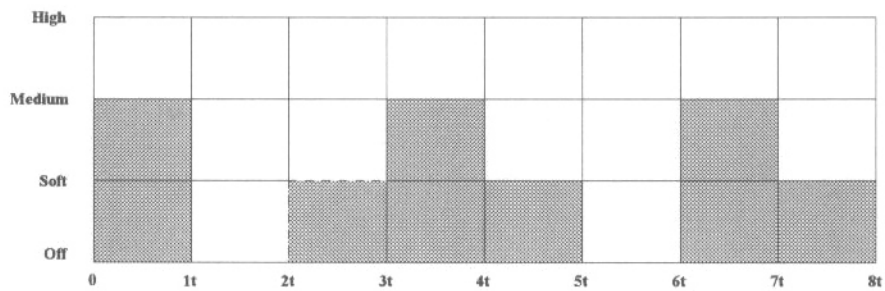
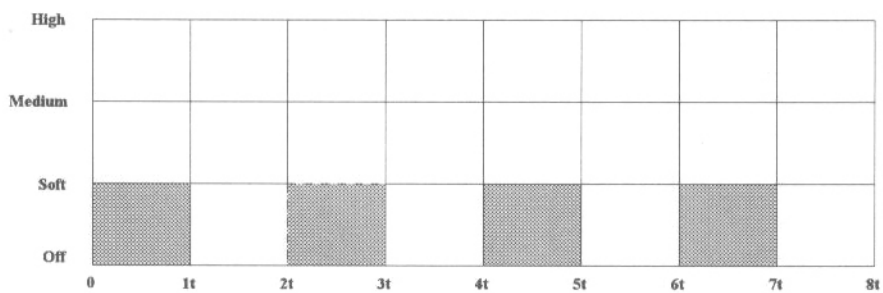
Strong-Rhythmical Wind

Medium-Rhythmical Wind

Soft-Rhythmical Wind

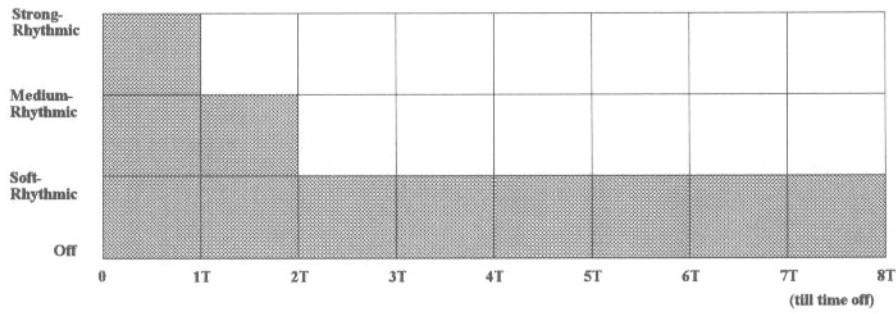
• Sleep Wind: (T = 0.5hr)

Strong-Sleep Wind

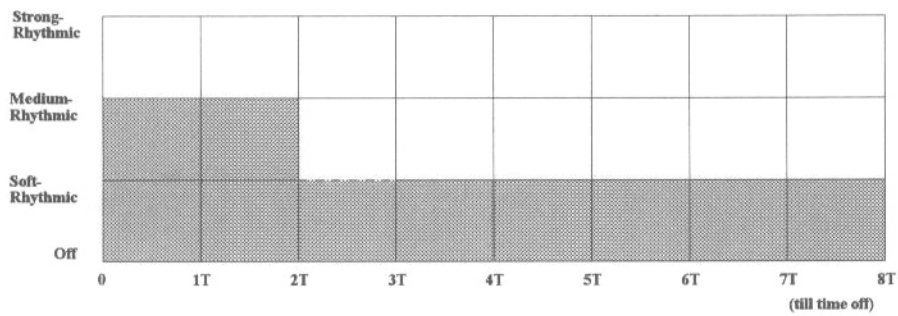

Medium-Sleep Wind



Soft-Sleep Wind

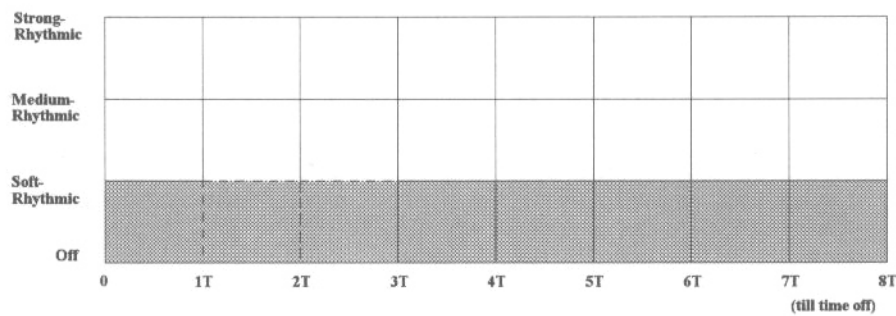

Application Circuit

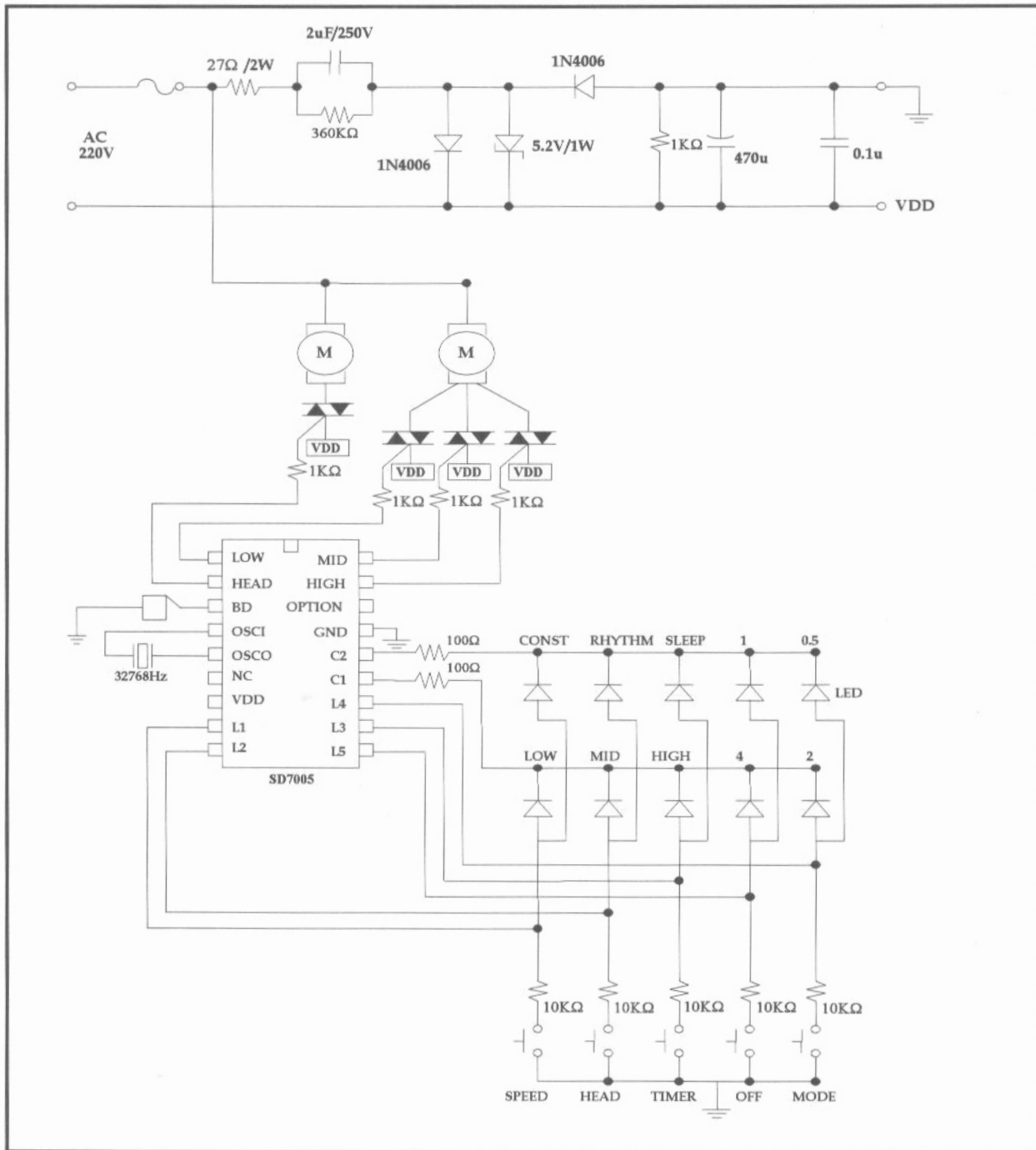

Fig 1. SD7005 Typical Application Circuit.

Bonding Diagram
